



An Infineon Technologies Company

IRF330
JANTX2N6760
JANTXV2N6760

REPETITIVE AVALANCHE AND dv/dt RATED
HEXFET[®] TRANSISTORS
THRU-HOLE (TO-204AA)

400V, N-CHANNEL
REF: MIL-PRF-19500/542

Product Summary

Part Number	BV_{DSS}	$R_{DS(on)}$	I_D
IRF330	400V	1.00 Ω	5.5A



Description

HEXFET[®] MOSFET technology is the key to IR HiRel advanced line of power MOSFET transistors. The efficient geometry and unique processing of this latest "State of the Art" design achieves: very low on-state resistance combined with high trans conductance; superior reverse energy and diode recovery dv/dt capability.

The HEXFET transistors also feature all of the well established advantages of MOSFETs such as voltage control, very fast switching and temperature stability of the electrical parameters.

They are well suited for applications such as switching power supplies, motor controls, inverters, choppers, audio amplifiers and high energy pulse circuits.

Features

- Repetitive Avalanche Ratings
- Dynamic dv/dt Rating
- Hermetically Sealed
- Simple Drive Requirements
- ESD Rating: Class 1C per MIL-STD-750, Method 1020

Absolute Maximum Ratings

Symbol	Parameter	Value	Units
$I_{D1} @ V_{GS} = 10V, T_C = 25^\circ C$	Continuous Drain Current	5.5	A
$I_{D2} @ V_{GS} = 10V, T_C = 100^\circ C$	Continuous Drain Current	3.5	
$I_{DM} @ T_C = 25^\circ C$	Pulsed Drain Current ^①	22	
$P_D @ T_C = 25^\circ C$	Maximum Power Dissipation	75	W
	Linear Derating Factor	0.60	W/ $^\circ C$
V_{GS}	Gate-to-Source Voltage	± 20	V
E_{AS}	Single Pulse Avalanche Energy ^②	1.7	mJ
I_{AR}	Avalanche Current ^①	5.5	A
E_{AR}	Repetitive Avalanche Energy ^①	7.5	mJ
dv/dt	Peak Diode Recovery ^③	4.0	V/ns
T_J T_{STG}	Operating Junction and Storage Temperature Range	-55 to + 150	$^\circ C$
	Lead Temperature	300 (0.063 in. (1.6mm) from case for 10s)	
	Weight	11.5 (Typical)	

For footnotes refer to the page 2.

Electrical Characteristics @ T_j = 25°C (Unless Otherwise Specified)

Symbol	Parameter	Min.	Typ.	Max.	Units	Test Conditions
BV _{DSS}	Drain-to-Source Breakdown Voltage	400	—	—	V	V _{GS} = 0V, I _D = 1.0mA
ΔBV _{DSS} /ΔT _J	Breakdown Voltage Temp. Coefficient	—	0.46	—	V/°C	Reference to 25°C, I _D = 1.0mA
R _{DS(on)}	Static Drain-to-Source On-Resistance	—	—	1.00	Ω	V _{GS} = 10V, I _{D2} = 3.5A ④
		—	—	1.22		V _{GS} = 10V, I _{D1} = 5.5A ④
V _{GS(th)}	Gate Threshold Voltage	2.0	—	4.0	V	V _{DS} = V _{GS} , I _D = 250μA
I _{DSS}	Zero Gate Voltage Drain Current	—	—	25	μA	V _{DS} = 320V, V _{GS} = 0V
		—	—	250		V _{DS} = 320V, V _{GS} = 0V, T _J = 125°C
I _{GSS}	Gate-to-Source Leakage Forward	—	—	100	nA	V _{GS} = 20V
	Gate-to-Source Leakage Reverse	—	—	-100		V _{GS} = -20V
Q _G	Total Gate Charge	17	—	39	nC	I _{D1} = 5.5A
Q _{GS}	Gate-to-Source Charge	2.0	—	6.0		V _{DS} = 200V
Q _{GD}	Gate-to-Drain ('Miller') Charge	8.0	—	20		V _{GS} = 10V
t _{d(on)}	Turn-On Delay Time	—	—	30	ns	V _{DD} = 200V
t _r	Rise Time	—	—	40		I _{D1} = 5.5A
t _{d(off)}	Turn-Off Delay Time	—	—	80		R _G = 7.5Ω
t _f	Fall Time	—	—	35		V _{GS} = 10V
L _S + L _D	Total Inductance	—	6.1	—	nH	Measured from Drain lead (6mm / 0.25 in from package) to Source lead (6mm / 0.25 in from package)
C _{iss}	Input Capacitance	—	620	—	pF	V _{GS} = 0V
C _{oss}	Output Capacitance	—	200	—		V _{DS} = 25V
C _{rss}	Reverse Transfer Capacitance	—	75	—		f = 1.0MHz

Source-Drain Diode Ratings and Characteristics

Symbol	Parameter	Min.	Typ.	Max.	Units	Test Conditions
I _S	Continuous Source Current (Body Diode)	—	—	5.5	A	
I _{SM}	Pulsed Source Current (Body Diode) ①	—	—	22		
V _{SD}	Diode Forward Voltage	—	—	1.4	V	T _J = 25°C, I _S = 5.5A, V _{GS} = 0V ④
t _{rr}	Reverse Recovery Time	—	—	700	ns	T _J = 25°C, I _F = 5.5A, V _{DD} ≤ 30V
Q _{rr}	Reverse Recovery Charge	—	—	6.2	μC	di/dt = 100A/μs ④
t _{on}	Forward Turn-On Time	Intrinsic turn-on time is negligible (turn-on is dominated by L _S +L _D)				

Thermal Resistance

Symbol	Parameter	Min.	Typ.	Max.	Units
R _{θJC}	Junction-to-Case	—	—	1.67	°C/W
R _{θJA}	Junction-to-Ambient (Typical socket mount)	—	—	30	

Footnotes:

- ① Repetitive Rating; Pulse width limited by maximum junction temperature.
- ② V_{DD} = 50V, starting T_J = 25°C, L = 0.11mH, Peak I_L = 5.5A, V_{GS} = 10V.
- ③ I_{SD} ≤ 5.5A, di/dt ≤ 90A/μs, V_{DD} ≤ 400V, T_J ≤ 150°C. Suggested R_G = 7.5 Ω
- ④ Pulse width ≤ 300 μs; Duty Cycle ≤ 2%

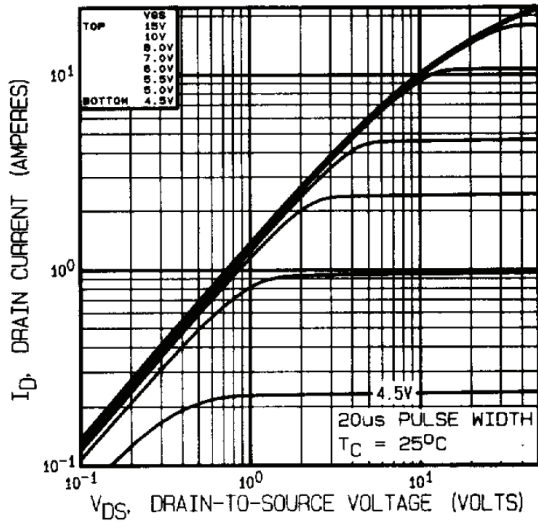

Fig 1. Typical Output Characteristics

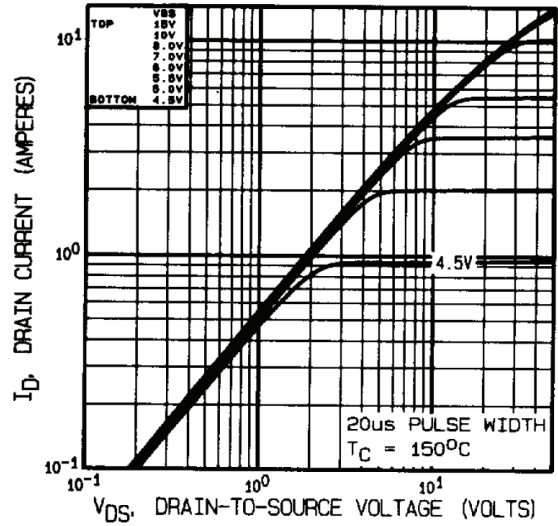

Fig 2. Typical Output Characteristics

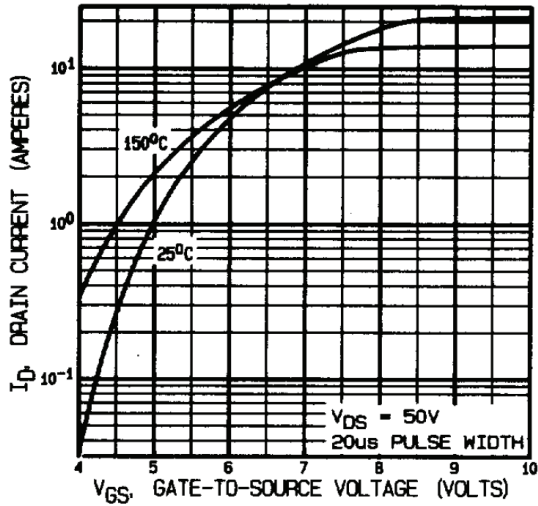

Fig 3. Typical Transfer Characteristics

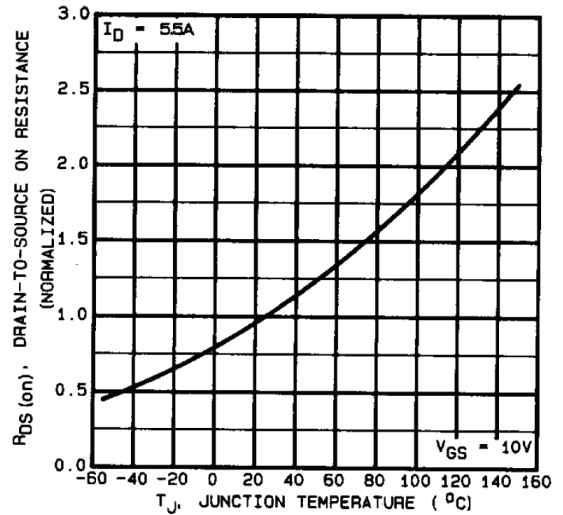

Fig 4. Normalized On-Resistance Vs. Temperature

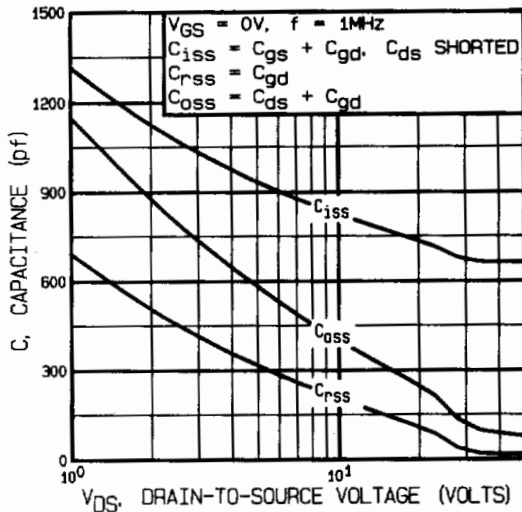

Fig 5. Typical Capacitance Vs. Drain-to-Source Voltage

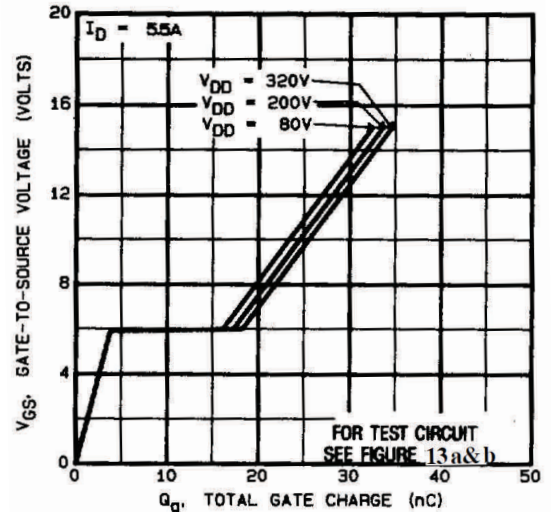

Fig 6. Typical Gate Charge Vs. Gate-to-Source Voltage

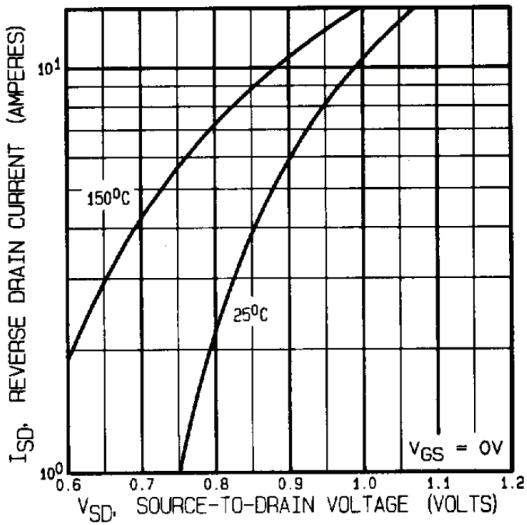

Fig 7. Typical Source-Drain Diode Forward Voltage

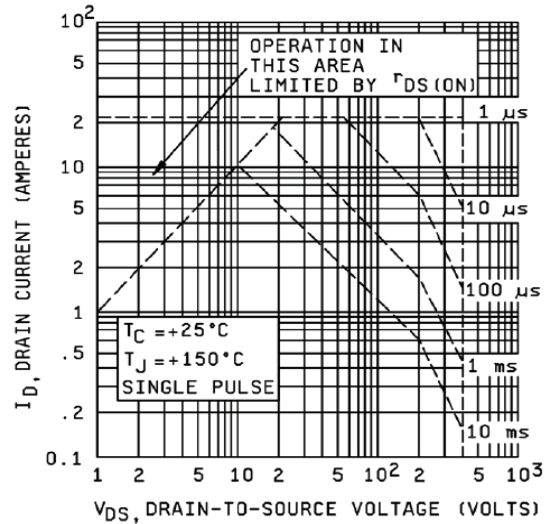

Fig 8. Maximum Safe Operating Area

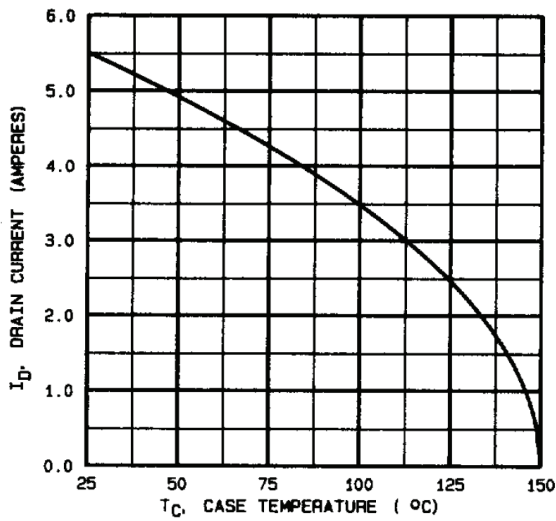

Fig 9. Maximum Drain Current Vs. Case Temperature

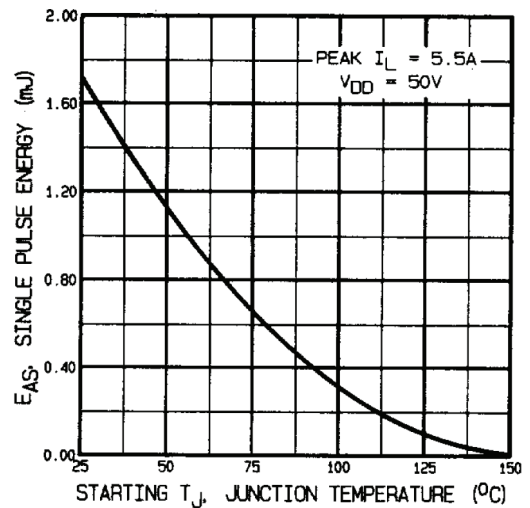

Fig 10. Maximum Avalanche Energy Vs. Drain Current

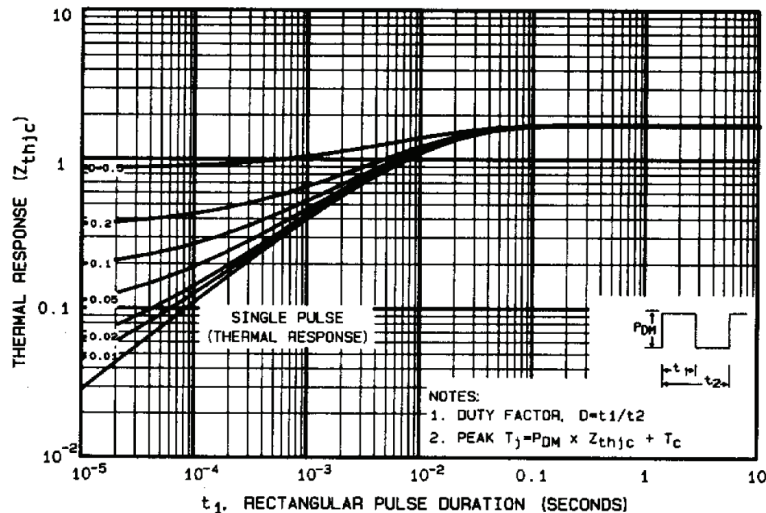

Fig 11. Maximum Effective Transient Thermal Impedance, Junction-to-Case

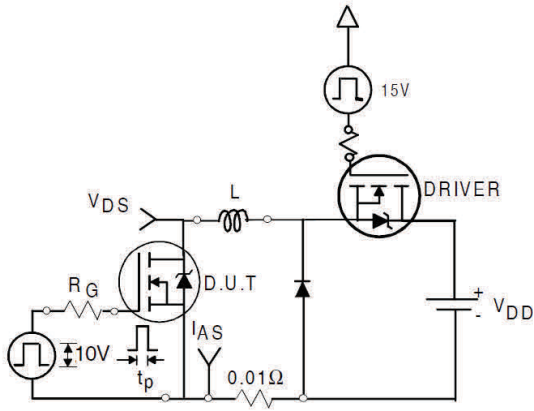

Fig 12a. Unclamped Inductive Test Circuit

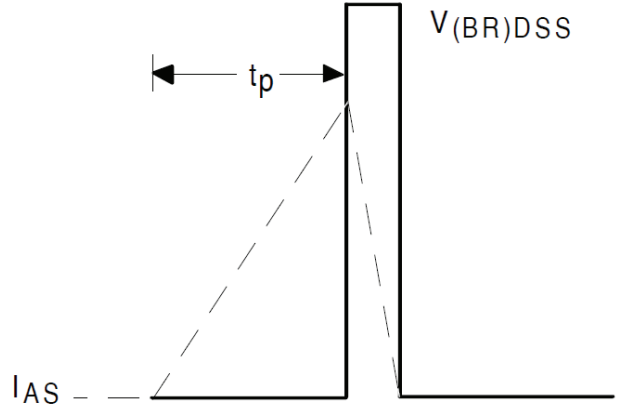

Fig 12b. Unclamped Inductive Waveforms

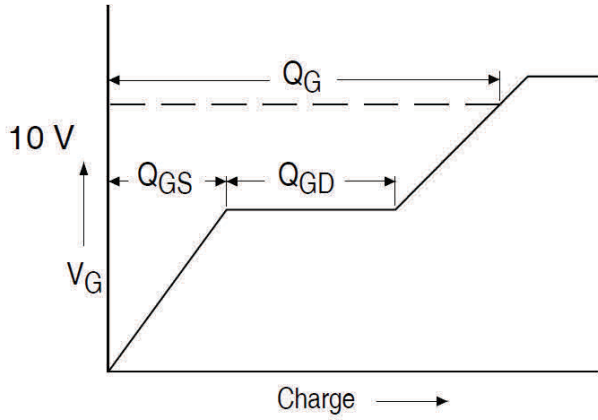

Fig 13a. Gate Charge Waveform

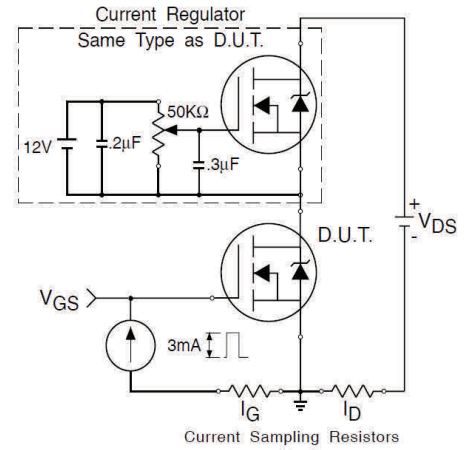

Fig 13b. Gate Charge Test Circuit

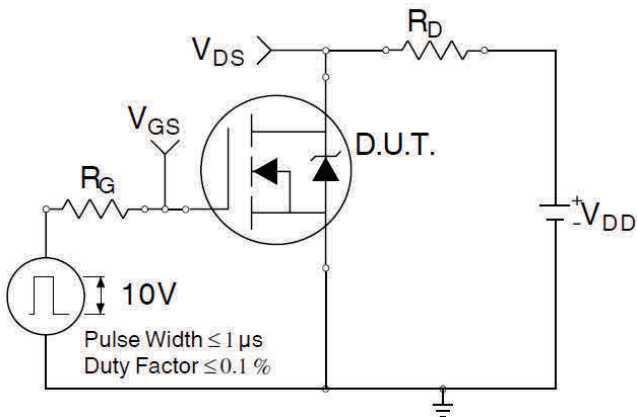

Fig 14a. Switching Time Test Circuit

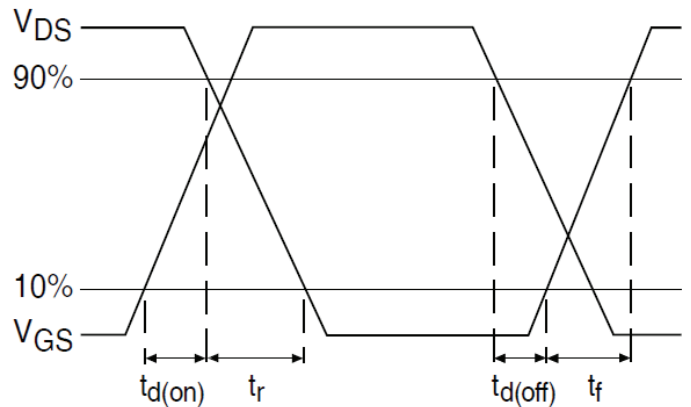
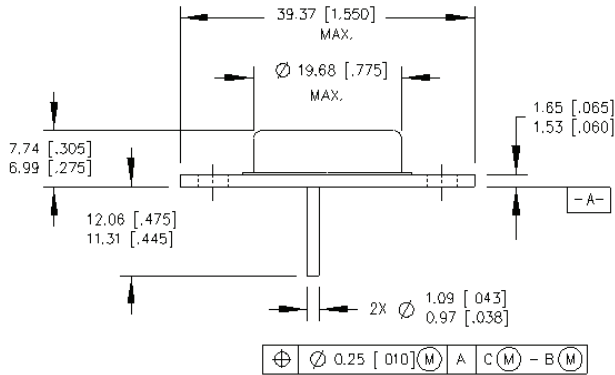

Fig 14b. Switching Time Waveforms

Case Outline and Dimensions - TO-204AA (Modified TO-3)



PIN ASSIGNMENTS

HEXFET

- 1 - SOURCE
- 2 - GATE
- 3 - DRAIN (CASE)

SCHOTTKY

- 1 - ANODE 1
- 2 - ANODE 2
- 3 - COMMON CATHOD (CASE)

IGBT

- 1 - GATE
- 2 - EMITTER
- 3 - COLLECTOR (CASE)

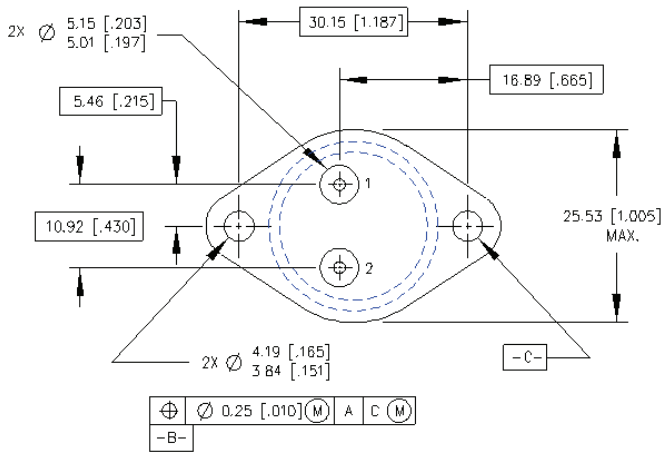

- NOTES:
1. DIMENSIONING & TOLERANCING PER ANSI Y14.5M - 1982.
 2. CONTROLLING DIMENSION : INCH.
 3. DIMENSIONS ARE SHOWN IN MILLIMETERS [INCHES]
 4. OUTLINE CONFORMS TO JEDEC OUTLINE TO -204-AA.

IMPORTANT NOTICE

The information given in this document shall be in no event regarded as guarantee of conditions or characteristic. The data contained herein is a characterization of the component based on internal standards and is intended to demonstrate and provide guidance for typical part performance. It will require further evaluation, qualification and analysis to determine suitability in the application environment to confirm compliance to your system requirements.

With respect to any example hints or any typical values stated herein and/or any information regarding the application of the product, Infineon Technologies hereby disclaims any and all warranties and liabilities of any kind including without limitation warranties on non- infringement of intellectual property rights and any third party.

In addition, any information given in this document is subject to customer's compliance with its obligations stated in this document and any applicable legal requirements, norms and standards concerning customer's product and any use of the product of Infineon Technologies in customer's applications.

The data contained in this document is exclusively intended for technically trained staff. It is the responsibility of any customer's technical departments to evaluate the suitability of the product for the intended applications and the completeness of the product information given in this document with respect to applications.

For further information on the product, technology, delivery terms and conditions and prices, please contact your local sales representative or go to (www.infineon.com/hirel).

WARNING

Due to technical requirements products may contain dangerous substances. For information on the types in question, please contact your nearest Infineon Technologies office.