

15W isolated DC-DC converter in DIP package,
Wide input and regulated single output

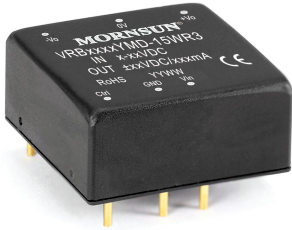

FEATURES

- Wide 2:1 input voltage range
- High efficiency up to 91%
- I/O isolation test voltage 1.5k VDC
- Input under-voltage protection, output short-circuit, over-current, over-voltage protection
- Operating ambient temperature range: -40°C to +105°C
- Meets CISPR32/EN55032 CLASS A, without extra components
- Industry standard pin-out

VRB_YMD-15WR3 series of isolated DC-DC converter products feature a wide 2:1 input voltage with efficiencies of up to 91%, 1500VDC input to output isolation, an operating ambient temperature range of -40°C to +105°C, input under-voltage protection, output short-circuit, over-current, over-voltage protection, CISPR32/EN55032 CLASS A EMI compliant without external components, which makes them widely used in industrial control, electric power, instruments and communications applications.

Selection Guide

Certification	Part No.	Input Voltage (VDC)		Output		Full Load Efficiency ² (%) Min./Typ.	Capacitive Load (μF)Max.
		Nominal (Range)	Max. ①	Voltage (VDC)	Current(mA) Max./Min.		
EN/BS EN	VRB1203YMD-15WR3	12 (9-18)	20	3.3	4000/0	86/88	4700
	VRB1205YMD-15WR3			5	3000/0	88/90	4700
	VRB1212YMD-15WR3			12	1250/0	88/90	1000
	VRB1215YMD-15WR3			15	1000/0	89/91	820
	VRB1224YMD-15WR3			24	625/0	89/91	270
	VRB2403YMD-15WR3	24 (18-36)	40	3.3	4000/0	86/88	4700
	VRB2405YMD-15WR3			5	3000/0	88/90	4700
	VRB2412YMD-15WR3			12	1250/0	88/90	1000
	VRB2415YMD-15WR3			15	1000/0	89/91	820
	VRB2424YMD-15WR3			24	625/0	88/90	270
	VRB4803YMD-15WR3	48 (36-75)	80	3.3	4000/0	86/88	4700
	VRB4805YMD-15WR3			5	3000/0	88/90	4700
	VRB4812YMD-15WR3			12	1250/0	89/91	1000
	VRB4815YMD-15WR3			15	1000/0	89/91	820
	VRB4824YMD-15WR3			24	625/0	89/91	270

Notes:

- ① Exceeding the maximum input voltage may cause permanent damage;
② Efficiency is measured at nominal input voltage and rated output load.

Input Specifications

Item	Operating Conditions	Min.	Typ.	Max.	Unit	
Input Current (full load / no-load)	12VDC nominal input series, nominal input voltage	3.3V output	--	1250/40	1280/65	mA
		5V output	--	1389/40	1421/65	
		12V output	--	1389/7	1421/22	
		15V output	--	1374/7	1405/22	
		24V output	--	1374/12	1405/22	
	24VDC nominal input series, nominal input voltage	3.3V output	--	625/30	647/50	
		5V output	--	695/30	711/50	
		12V output	--	695/6	711/15	

Input Current (full load / no-load)	24VDC nominal input series, nominal input voltage	15V output	--	687/6	703/15	mA
		24V output	--	687/10	703/20	
	48VDC nominal input series, nominal input voltage	3.3V output	--	313/15	320/30	
		5V output	--	348/15	356/30	
		12V output	--	344/3	352/11	
		15V output	--	344/3	352/11	
24V output	--	344/4	352/11			
Reflected Ripple Current	Nominal input voltage		--	30	--	
Surge Voltage (1sec. max.)	12VDC nominal input series		-0.7	--	25	VDC
	24VDC nominal input series		-0.7	--	50	
	48VDC nominal input series		-0.7	--	100	
Start-up Voltage	12VDC nominal input series		--	--	9	
	24VDC nominal input series		--	--	18	
	48VDC nominal input series		--	--	36	
Under-voltage Protection	12VDC nominal input series		5.5	6.5	--	
	24VDC nominal input series		12	15.5	--	
	48VDC nominal input series		26	30	--	
Start-up Time	Nominal input voltage & constant resistance load		--	10	--	ms
Input Filter	PI filter					
Hot Plug	Unavailable					
Ctrl *	Module on		Ctrl pin open or pulled high (TTL 3.5-12VDC)			
	Module off		Ctrl pin pulled low to GND (0-1.2VDC)			
	Input current when off		--	2	7	mA

Note: *The Ctrl pin voltage is referenced to input GND.

Output Specifications

Item	Operating Conditions	Min.	Typ.	Max.	Unit	
Voltage Accuracy	0%-100% load	--	±1	±3	%	
Linear Regulation	Input voltage variation from low to high at full load	--	±0.2	±0.5		
Load Regulation	5%-100% load	--	±0.5	±1		
Transient Recovery Time	25% load step change, nominal input voltage	--	300	500	μs	
Transient Response Deviation		3.3V, 5V output	--	±3	±7	%
		Others	--	±3	±5	
Temperature Coefficient	Full load	--	--	±0.03	%/°C	
Ripple & Noise ^①	20MHz bandwidth, 5%-100% load	--	50	100	mV p-p	
Trim	Input voltage range	90	--	110	%Vo	
Over-voltage Protection		110	--	160		
Over-current Protection		110	150	190	%Io	
Short-circuit protection		Hiccup, continuous, self-recovery				

Note: ① Under 0% -5% load conditions, ripple & noise does not exceed 5%Vo. The "parallel cable" method is used for Ripple and Noise test, please refer to DC-DC Converter Application Notes for specific information.

General Specifications

Item	Operating Conditions	Min.	Typ.	Max.	Unit	
Isolation	Input-output Electric Strength Test for 1 minute with a leakage current of 1mA max.	1500	--	--	VDC	
	Input/output-case Electric Strength Test for 1 minute with a leakage current of 1mA max.	1000	--	--		
Insulation Resistance	Input-output resistance at 500VDC	1000	--	--	MΩ	
Isolation Capacitance	Input-output capacitance at 100kHz/0.1V	--	2000	--	pF	
Operating Temperature	See Fig. 1	3.3V, 5V output	-40	--	+95	°C
		Others	-40	--	+105	
Storage Temperature		-55	--	+125		

Storage Humidity	Non-condensing	5	--	95	%RH
Pin Soldering Resistance Temperature	Soldering spot is 1.5mm away from case for 10 seconds	--	--	+300	°C
Vibration		10-150Hz, 5G, 0.75mm. along X, Y and Z			
Switching Frequency *	PWM mode	3.3V, 5V output	--	300	--
		Others	--	270	--
MTBF	MIL-HDBK-217F@25°C	1000	--	--	k hours

Note: *Switching frequency is measured at full load. The module reduces the switching frequency for light load (below 50%) efficiency improvement.

Mechanical Specifications

Case Material	Aluminum alloy
Dimensions	25.40 × 25.40 × 11.70 mm
Weight	15.0g (Typ.)
Cooling method	Free air convection

Electromagnetic Compatibility (EMC)

Emissions	CE	CISPR32/EN55032	CLASS A (without external components)/ CLASS B (see Fig.3-② for recommended circuit)	
	RE	CISPR32/EN55032	CLASS A (without external components)/ CLASS B (see Fig.3-② for recommended circuit)	
Immunity	ESD	IEC/EN61000-4-2	Contact ±6kV, Air ±8kV	perf. Criteria B
	RS	IEC/EN61000-4-3	10V/m	perf. Criteria A
	EFT	IEC/EN61000-4-4	±2kV (see Fig.3-① for recommended circuit)	perf. Criteria A
	Surge	IEC/EN61000-4-5	line to line ±2kV (see Fig.3-① for recommended circuit)	perf. Criteria B
	CS	IEC/EN61000-4-6	3 V _{r.m.s}	perf. Criteria A

Typical Characteristic Curve

Nominal input voltage, 12V, 15V, 24V output

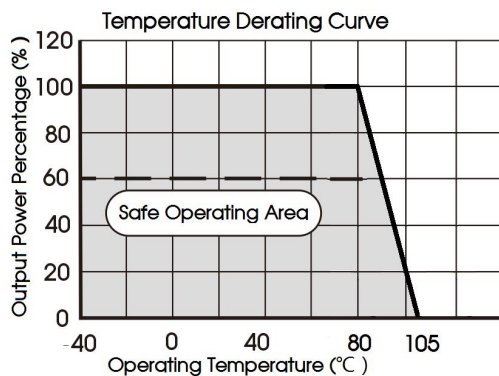

Nominal input voltage, 3.3V, 5V output

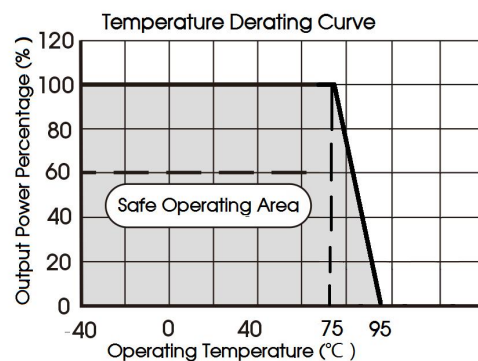
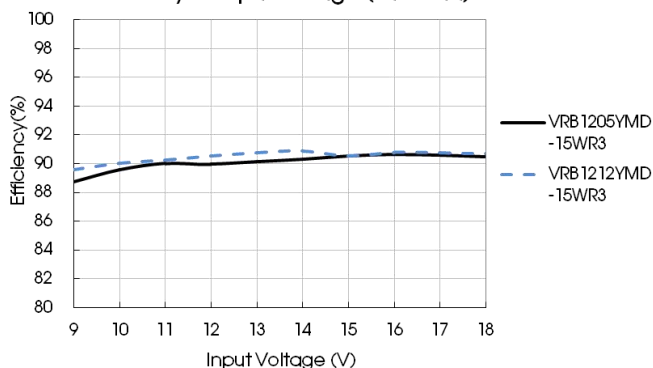
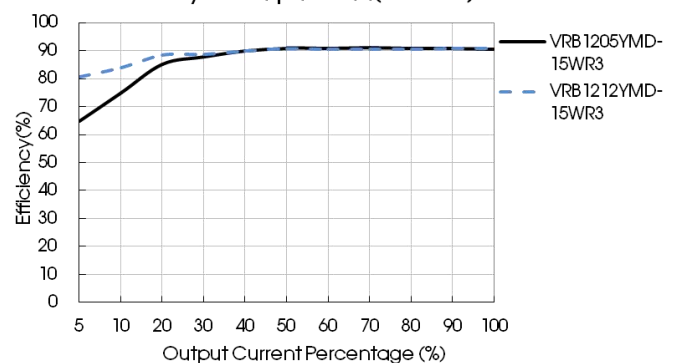

Fig. 1

Efficiency Vs Input Voltage (Full Load)



Efficiency Vs Output Load (Vin=12V)



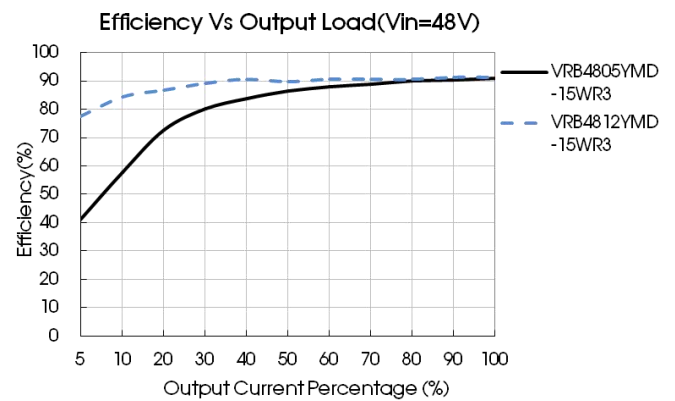
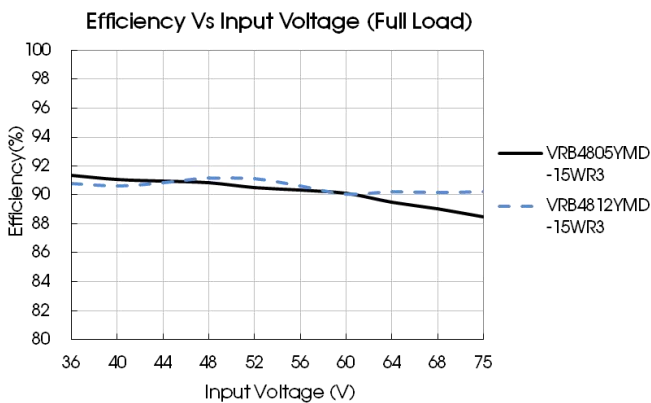
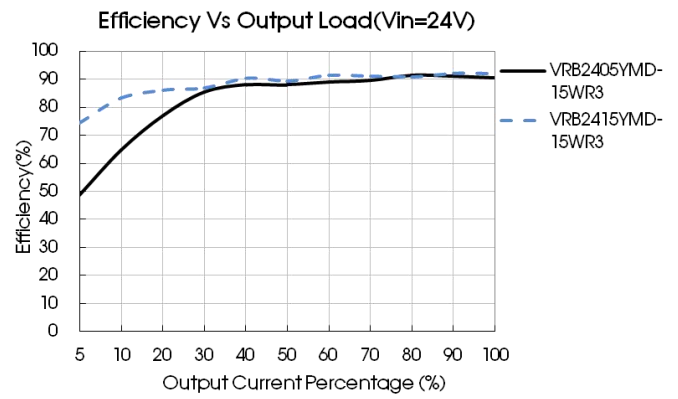
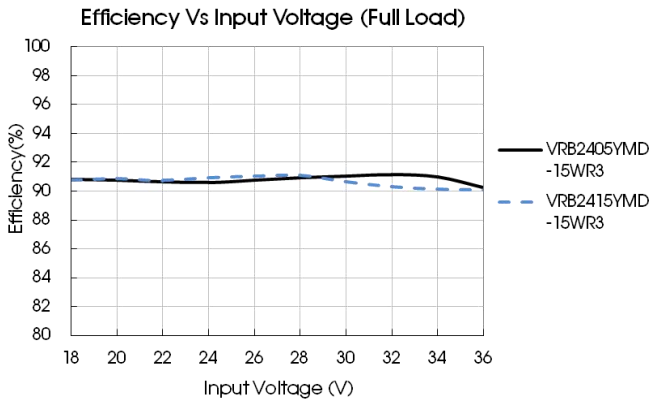

Design Reference

1. Typical application

All DC-DC converters of this series are tested before delivery using the recommended circuit shown in Fig. 2.

Input and/or output ripple can be further reduced by appropriately increasing the input & output capacitor values C_{in} and C_{out} and/or by selecting capacitors with a low ESR (equivalent series resistance). Also make sure that the capacitance is not exceeding the specified max. capacitive load value of the product.



Fig. 2

Vin (VDC)	Vout (VDC)	Cin	Cout
12	3.3/5	100μF/50V	100μF/16V
	12/15		100μF/25V
	24		47μF/50V
24	3.3/5	100μF/50V	100μF/16V
	12/15		100μF/25V
	24		47μF/50V
48	3.3/5	100μF/100V	100μF/16V
	12/15		100μF/25V
	24		47μF/50V

2. EMC compliance circuit

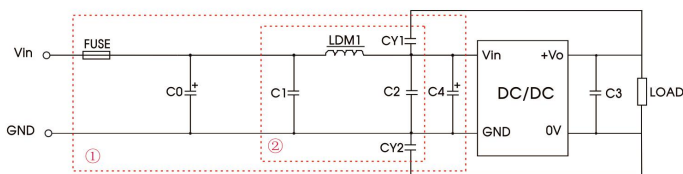

Fig. 3

Notes: For EMC tests we use Part ① in Fig. 3 for immunity and part ② for emissions test. Selecting based on needs.

Parameter description:

Model	Vin: 12VDC/24VDC	Vin: 48VDC
FUSE	Select fuse value according to actual input current	
C0, C4	330μF/50V	330μF/100V
C1, C2	4.7μF/50V	4.7μF/100V
C3	Refer to the Cout in Fig.2	
LDM1	2.2μH/4A	2.2μH/2A
CY1/CY2	1nF/2kV	

3. Trim Function for Output Voltage Adjustment (open if unused)

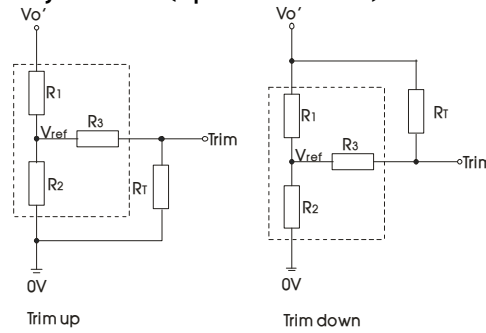

TRIM resistor connection (dashed line shows internal resistor network)

Calculating Trim resistor values:

$$\begin{aligned} \text{up: } R_T &= \frac{\alpha R_2}{R_2 - \alpha} \cdot R_3 & \alpha &= \frac{V_{ref}}{V_{O'} - V_{ref}} \cdot R_1 & R_T &= \text{Trim Resistor value;} \\ & & & & \alpha &= \text{self-defined parameter;} \\ \text{down: } R_T &= \frac{\alpha R_1}{R_1 - \alpha} \cdot R_3 & \alpha &= \frac{V_{O'} - V_{ref}}{V_{ref}} \cdot R_2 & V_{O'} &= \text{desired output voltage} \end{aligned}$$

Vout(V)	R1(kΩ)	R2(kΩ)	R3(kΩ)	Vref(V)
3.3	4.772	2.87	15	1.25
5	2.894	2.87	10	2.5
12	11.000	2.87	17.4	2.5
15	14.494	2.87	17.4	2.5
24	24.872	2.87	20	2.5

- The products do not support parallel connection of their output
- For additional information please refer to DC-DC converter application notes on www.mornsun-power.com

Dimensions and Recommended Layout

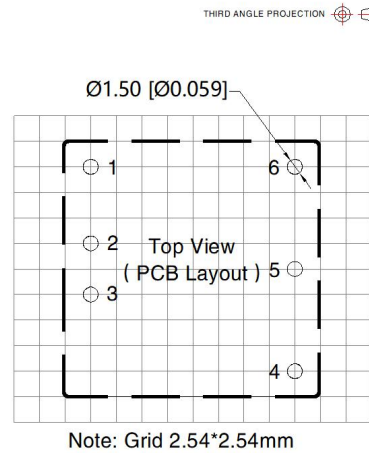
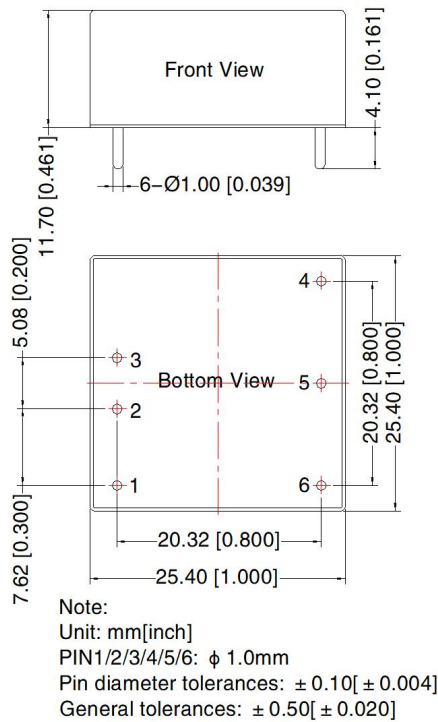

Pin-Out	
Pin	Mark
1	Ctrl
2	GND
3	Vin
4	+Vo
5	Trim
6	0V

- Note:
- For additional information on Product Packaging please refer to www.mornsun-power.com. Packaging bag number : 58210003 (DIP);
 - If the product is not operated within the required load range, the product performance cannot be guaranteed to comply with all parameters in the datasheet;
 - The maximum capacitive load offered were tested at input voltage range and full load;
 - Unless otherwise specified, parameters in this datasheet were measured under the conditions of $T_a=25^\circ\text{C}$, humidity<75%RH with nominal input voltage and rated output load;
 - All index testing methods in this datasheet are based on company corporate standards;
 - We can provide product customization service, please contact our technicians directly for specific information;
 - Products are related to laws and regulations: see "Features" and "EMC";
 - Our products shall be classified according to ISO14001 and related environmental laws and regulations, and shall be handled by qualified units.

Mornsun Guangzhou Science & Technology Co., Ltd.

Address: No. 5, Kehui St. 1, Kehui Development Center, Science Ave., Guangzhou Science City, Huangpu District, Guangzhou, P. R. China
 Tel: 86-20-38601850 Fax: 86-20-38601272 E-mail: info@mornsun.cn www.mornsun-power.com