

Since 1968

COMMAX
SmartHome & Security

User Manual

Color video door phone CDV-43Q



www.commax.com

COMMAX Co.,Ltd.



- Thank you for purchasing COMMAX products.
- Please carefully read this User's Guide (in particular, precautions for safety) before using a product and follow instructions to use a product exactly.
- The company is not responsible for any safety accidents caused by abnormal operation of the product.



Table of Contents

- 1. Warnings and Cautions.....2
- 2. Part Names3
- 3. Contents3
- 4. Wiring and Connection Instructions.....4
- 5. Installation.....4
- 6. Operation5
- 7. Specifications.....7









1. Warnings and caution











Please follow the things described below in order to prevent any danger or property damage.

 **Warning** It may cause a serious damage or injury if violated.

 **Caution** It may cause a minor damage or injury if violated.

-  Prohibition.
-  No disassembly
-  No touch
-  Must follow strictly.
-  Shows plugging out the power cord without an exception
-  Shows the warning and caution for an electric shock.
-  Shows the warning and caution for a fire.

Warning & Caution

Cleaning & Use	<p>Please don't disassemble, repair or rebuild this product arbitrarily (please contact the service center if a repair is needed).</p> <ul style="list-style-type: none"> · It may cause an electric shock or fire. 	<p>If an abnormal sound, burning smell or smoke is coming out of the product, please plug out the power cable and contact a service center.</p> <ul style="list-style-type: none"> · It may cause an electric shock or fire. 	<p>Please don't insert any metallic or burnable materials into the ventilation hole.</p> <ul style="list-style-type: none"> · It may cause an electric shock or fire. 	<p>When cleaning the product, please rub it with a soft and dry cloth after plugging out the power cable. (Please don't use any chemical products such as wax, benzene, alcohol or cleanser.)</p>	
					
					
	No disassembly	Electric shock	Fire	Electric shock	Fire

Warning & Caution

Power & Installation

Please don't use several products at the same time on one power socket.
 · It may cause a fire due to an abnormal overheating.

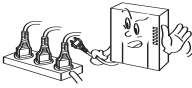

Please don't bend the power cable excessively or it may cause an electric shock.
 · fire when using a damaged power cable.

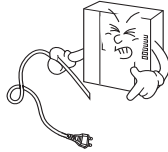

Please don't handle the power cable with a wet hand.
 · It may cause an electric shock.

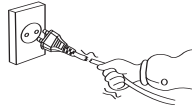

Please plug out the power cable from the socket when not using it for a long period of time.
 · It may shorten the product lifespan or cause a fire.



Please don't install the product in the place where there is much oil, smoke or humidity.
 · It may cause an electric shock or fire.

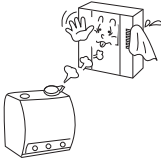

Please don't install the product with the lightning and thunder.
 · It may cause an electric shock or fire.

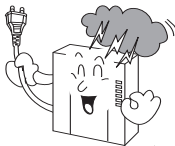

Please don't use and connect this product with other products with different rated voltage.
 · It may cause a disorder or fire.

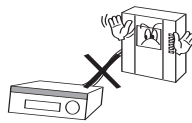

When installing the product that generates heat, please install the product away from the wall (10cm) for the ventilation.
 · It may cause a fire due to the increased internal temperature.

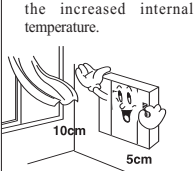

2. Parts Names

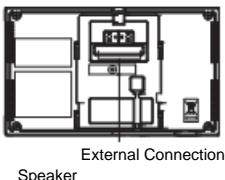
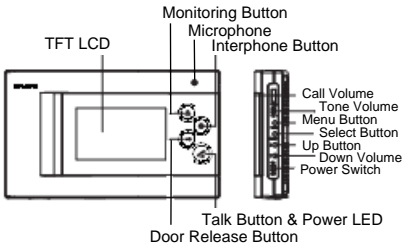

3. Contents

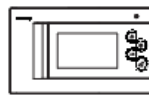

Video Phone
(CDV-43Q)

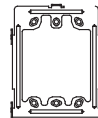

Wall bracket
for monitor (1EA)



User Manual (1EA)



4P Connector
(2EA)



Monitor fixing
screw (1EA)

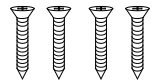

Wall bracket mounting
screw (4EA)



4. Wiring and Connection Instructions

▶ Polarity of the camera connector

1. Red: Talk (Audio)
2. Blue: GND
3. Yellow: Power (+12V)
4. White: Video

▶ Polarity of interphone connector

1. Red: Talk (Audio)
2. Blue: GND
3. Yellow: Power (+14V)
4. White: Call signal

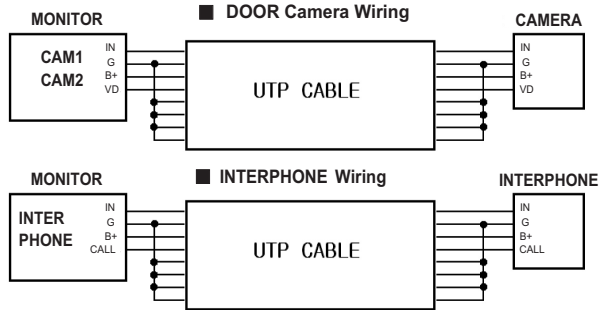
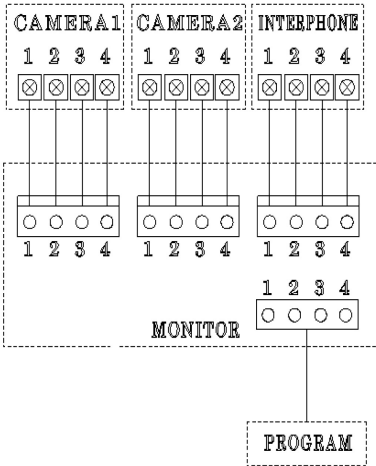

- ⚠ When adding a second monitor, visual and audio quality of video may deteriorate
- ⚠ When using UTP CABLE [CAT.5] for better image quality, connect the rest 4 lines to GND after connecting 4 lines with monitor and camera.



5. Installation

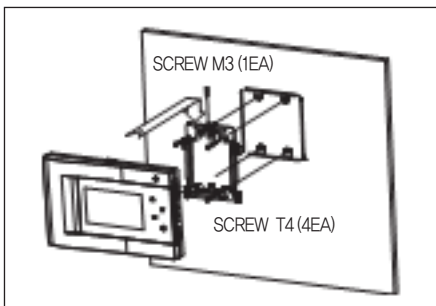

⚠ Cautions

- ① Avoid the direct sunlight.
- ② Recommended height is around 1450~1500mm
- ③ Avoid the installation near magnetic activity, humid temperature and gas.



6. Operation

1. Visitor calls from entrance

- ① When a visitor presses CALL button at entrance, the chime melody rings and visitor image is shown on the screen.
- ② Press TALK button to talk with the visitor and you can open the door by pressing DOOR RELEASE button. (DOOR RELEASE function is only possible during talking mode and CAMERA with door release function should be interlocked.)
- ③ By picking up the handset of additional interphone, 3-way communication is possible. (Simultaneous communication mode)
- ④ To finish talking, press TALK button again while you are talking with the visitor.

2. Talking with interphone

(1) Calls from interphone

- ① You can hear chime bell if someone calls you by interphone.
- ② You can talk with person by pressing interphone button.
- ③ When Visitor calls from door camera while household is talking with interphone, Image from door camera will be shown on the screen of household video phone with calling sound. 3-way communication is also possible between household, interphone and door camera.

(2) To call the interphone

- ① If you press interphone button on the monitor, you can call the interphone. (It is possible only during pressing the interphone button.)
- ② You can talk with interphone if someone answers.

3. Monitoring : function to see the image of visitor in the entrance.

(stand-by mode) Operation

- By pressing the Monitor button repeatedly, the monitor will work as following in order.

Camera 1 → (Camera 2) → OFF → Camera 1

(On talking mode)Operation

- By pressing Monitor button repeatedly, the monitor will work as following in order.

Camera1 → (Camera 2) → Camera 1 → (Camera 2)

4. Settings

- You can adjust DOOR VIDEO SET, UTILITY and check INFORMATION(model name &version) with (UP)△ / (DOWN)▽ button after pressing Menu button on the right of the product in video talk mode or stand-by mode.

• **Products settings need the following 4 buttons on the right of product.**

* Start Menu / Exit : MENU button * Select and in-put : SELECT button

* Move up / Move right : Δ (UP button)

* Move down / Move left : ∇ (DOWN button)

4-1. Screen setting (Brightness/Contrast/Color adjustment function)

Press the Menu button and access to DOOR VIDEO SET and enter the setting menu by pressing SELECT button.

(1) BRIGHTNESS : Adjusting Brightness of Screen

(2) CONTRAST : Adjusting Contrast of Screen

(3) COLOR : Adjusting Color of Screen

※ How to adjust

① Move to Menu you want to adjust with Δ/∇ button on the list of DOOR VIDEO SET

② Press SELECT button to choose an icon.

③ Adjust the set value with Δ/∇ button

④ To complete the set, press SELECT button.

(4) RESET : Initializing

※ How to Reset

① Move to RESET menu in DOOR VIDEO SET menu

② Press SELECT to enter the menu.

③ Select YES with Δ/∇ button

④ Press SELECT button.

(5) EXIT : Go back to setting mode

4-2. UTILITY(additional function)

Press the Menu button and access to Utility SET and enter the menu by pressing SELECT button.

(1) CHIME-BELL MUTE : setting mute sound

① Move to CHIME-BELL MUTE icon with Δ/∇ button in UTILITY Menu.

② Press SELECT to enter the menu.

③ Select the mute sound or not with Δ/∇ button.



: Chime-bell on



: Chime-bell off

④ To complete the set, press SELECT button.

(2) SCREEN MODE : to set for screen ratio

- ① ZOOM: Zoon in(expansion) image maintaining actual ratio(4:3) is shown. (full of the screen)
- ② 4:3: Image of 4:3 ratio without expansion is shown.(This is actual ratio for camera)
- ③ WIDE: Full of the screen. Not actual ratio (4:3). Image is expanded according to LCD (WIDE LCD) ratio.

※ How to adjust

- ① Access to SCREEN MODE with Δ / ∇ button in UTILITY Menu
- ② Press SELECT button to enter the menu.
- ③ Adjust screen ratio value with Δ / ∇ button.
- ④ To complete the set, press SELECT button.

(3) EXIT : Go back to Setting menu

4-3. INFORMATION (The function to check Model name & Version)

In order to check the product information, press menu button and move to INFORMATION menu with Δ / ∇ button.

- (1) Model : You can check the model name.
- (2) Version : You can check the model version.
- (3) VIDEO : You can check the video transmission formats(NTSC/PAL)
- (4) SOURCE : You can check the position of camera(DOOR1 / DOOR2) which is shown on the screen for now.

4-4. EXIT(Finish setting menu)



7. Specification

Wiring	Door camera 4 wires(polar), Interphone 4 wires (polar)
Rating voltage	100V-240V~, 50/60Hz (FREE VOLTAGE)
Power consumption	standby : 4.5W maximum : 10W
Communication way	HANDS FREE (Voice switch circuit)
Monitor	4.3" TFT-DIGITAL LCD
Call sound	- Entrance : electronic chime(3tone 2hit(Sol-Mi-Do)) - Interphone : electronic oscillations
Video receiving time	Monitoring mode : 30 °±5sec, Talking mode: 60 ±5sec
Distance	28m(∅ 0.5) / 50m(∅ 0.65) / 70m(∅ 0.8)
Working temperature	0 ~+40°C(32°F ~ 104°F)
Dimension	235.5(W) X 140(H) X 36(D) mm

COMMAX

COMMAX Co.,Ltd.

513-11, Sangdaewon-dong, Jungwon-gu, Seongnam-si, Gyeonggi-do, Korea

Int'l Business Dept. Tel. : +82-31-7393-540~550 Fax. : +82-31-745-2133

Web site : www.commax.com

PM0743Q00011

Printed In Korea / 2016.07.104