

# HF41F

# SUBMINIATURE POWER RELAY



File No.: E133481



File No.: 40020043



File No.: CQC17002175724

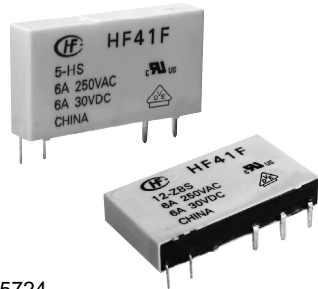

## Features

- Slim size (width 5mm)
- 6A switching capability 4kV dielectric strength (between coil and contacts)
- Surge voltage up to 6kV (between coil and contacts)
- Meeting VDE 0700, 0631 reinforce insulation
- High sensitive: Approx. 170mW
- Sockets available
- 1 Form A and 1 Form C configurations

**RoHS compliant**

## CONTACT DATA

Contact arrangement	1A, 1C
Contact resistance <sup>1)</sup>	100mΩ max. (at 1A 6VDC) Gold plated: 30mΩ max.(at 1A 6VDC)
Contact material	AgSnO <sub>2</sub> , AgNi
Contact rating (Res. load)	6A 250VAC / 30VDC
Max. switching voltage	400VAC / 125VDC
Max. switching current	6A
Max. switching power	1500VA / 180W
Mechanical endurance	1 x 10 <sup>7</sup> OPS
Electrical endurance	H type: 6 x 10 <sup>4</sup> OPS (6A 250VAC/30VDC, Resistive load, AgNi, at 85°C, 1s on 9s off) Z type: 3 x 10 <sup>4</sup> OPS (NO, 6A 250VAC/30VDC, Resistive load, AgNi, at 85°C, 1s on 9s off) 1 x 10 <sup>4</sup> OPS (NC, 6A 250VAC/30VDC, Resistive load, AgNi, at 85°C, 1s on 9s off)

Notes:1) The data shown above are initial values.

## CHARACTERISTICS

Insulation resistance	1000MΩ (at 500VDC)	
Dielectric strength	Between coil & contacts	4000VAC 1 min
	Between open contacts	1000VAC 1 min
Operate time (at nomi.volt.)	8ms max.	
Release time (at nomi.volt.)	4ms max.	
Shock resistance*1)	Functional	49m/s <sup>2</sup>
	Destructive	980m/s <sup>2</sup>
Vibration resistance*1)	10Hz to 55Hz 1mm DA	
Humidity	5% to 85% RH	
Ambient temperature	-40°C to 85°C	
Termination	PCB	
Unit weight	Approx. 5g	
Construction	Plastic sealed, Flux proofed	

Notes: 1) Index is that of relay without socket and is not in relay length direction.

2) The data shown above are initial values.

3) Please find coil temperature curve in the characteristic curves below.

4) Please do not install a SPDT(1 Form C) type relay on either of the smallest sides or facing downward.

5) UL insulation system: Class A.



HONGFA RELAY

ISO9001, ISO/TS16949, ISO14001, OHSAS18001, IECQ QC 080000 CERTIFIED

2020 Rev. 1.00

## COIL

Coil power	5VDC to 24VDC: Approx. 170mW
	48VDC, 60VDC: Approx. 210mW

## COIL DATA

at 23°C

Nominal Voltage VDC	Pick-up Voltage VDC max. <sup>1)</sup>	Drop-out Voltage VDC min. <sup>1)</sup>	Max. Voltage VDC <sup>3)</sup>	Coil Resistance Ω
5	3.75	0.25	7.5	147 x (1±10%)
6	4.50	0.30	9.0	212 x (1±10%)
9	6.75	0.45	13.5	476 x (1±10%)
12	9.00	0.60	18	848 x (1±10%)
18	13.5	0.90	27	1906 x (1±15%)
24	18.0	1.20	36	3390 x (1±15%)
48 <sup>4)</sup>	36.0	2.40	72	10600 x (1±15%)
60 <sup>4)</sup>	45.0	3.00	90	16600 x (1±15%)

Notes: 1) The data shown above are initial values.

2) When require pick-up voltage ≤ 70% nominal voltage, special order allowed.

3) Maximum voltage refers to the maximum voltage which relay coil could endure in a short period of time.

4) For products with rated voltage ≥ 48V, measures should be taken to prevent coil overvoltage in order to protect coil in test and application (eg. Connect diodes in parallel).

## SAFETY APPROVAL RATINGS

UL/CUL	6A 30VDC at 85°C
	6A 277VAC at 85°C
	R300 B300
VDE	6A 30VDC at 85°C
	6A 250VAC at 85°C

Notes: 1) All values unspecified are at room temperature.

2) Only typical loads are listed above. Other load specifications can be available upon request.

## ORDERING INFORMATION

Type	HF41F / 12 -H 8 S T G (XXX)					
Coil voltage	5, 6, 9, 12, 18, 24, 48, 60VDC					
Contact arrangement	H: 1 Form A		Z: 1 Form C			
Version <sup>1)</sup>	8: Flat pack version		Nil: Vertical version			
Construction <sup>2)3)</sup>	S: Plastic sealed		Nil: Flux proofed			
Contact material	T: AgSnO <sub>2</sub>		Nil: AgNi			
Contact plating <sup>4)</sup>	G: Gold plated		Nil: No gold plated			
Special code <sup>5)</sup>	XXX: Customer special requirement		Nil: Standard			

Notes: 1) We recommend flux proofed types for the flat pack version.

2) We recommend flux proofed types for a clean environment (free from contaminations like H<sub>2</sub>S, SO<sub>2</sub>, NO<sub>2</sub>, dust, etc.).

We suggest to choose plastic sealed types and validate it in real application for an unclean environment (with contaminations like H<sub>2</sub>S, SO<sub>2</sub>, NO<sub>2</sub>, dust, etc.).

3) Contact is recommended for suitable condition and specifications if water cleaning or surface process is involved in assembling relays on PCB.

4) For gold plated type, the min. switching current and min. switching voltage is 10mA 5VDC.

5) The customer special requirement express as special code after evaluating by Hongfa. e.g. (210) stands for pick-up voltage less than 70% of nominal voltage. e.g. (414) stands for wide coil pin type.

6) Standard tube packing length is 550mm. Any special requirement needed, please contact us for more details.

7) For products that should meet the explosion-proof requirements of "IEC 60079 series", please note [Ex] after the specification while placing orders. Not all products have explosion-proof certification, so please contact us if necessary, in order to select the suitable products.

## OUTLINE DIMENSIONS, WIRING DIAGRAM AND PC BOARD LAYOUT

Unit: mm

### Outline Dimensions

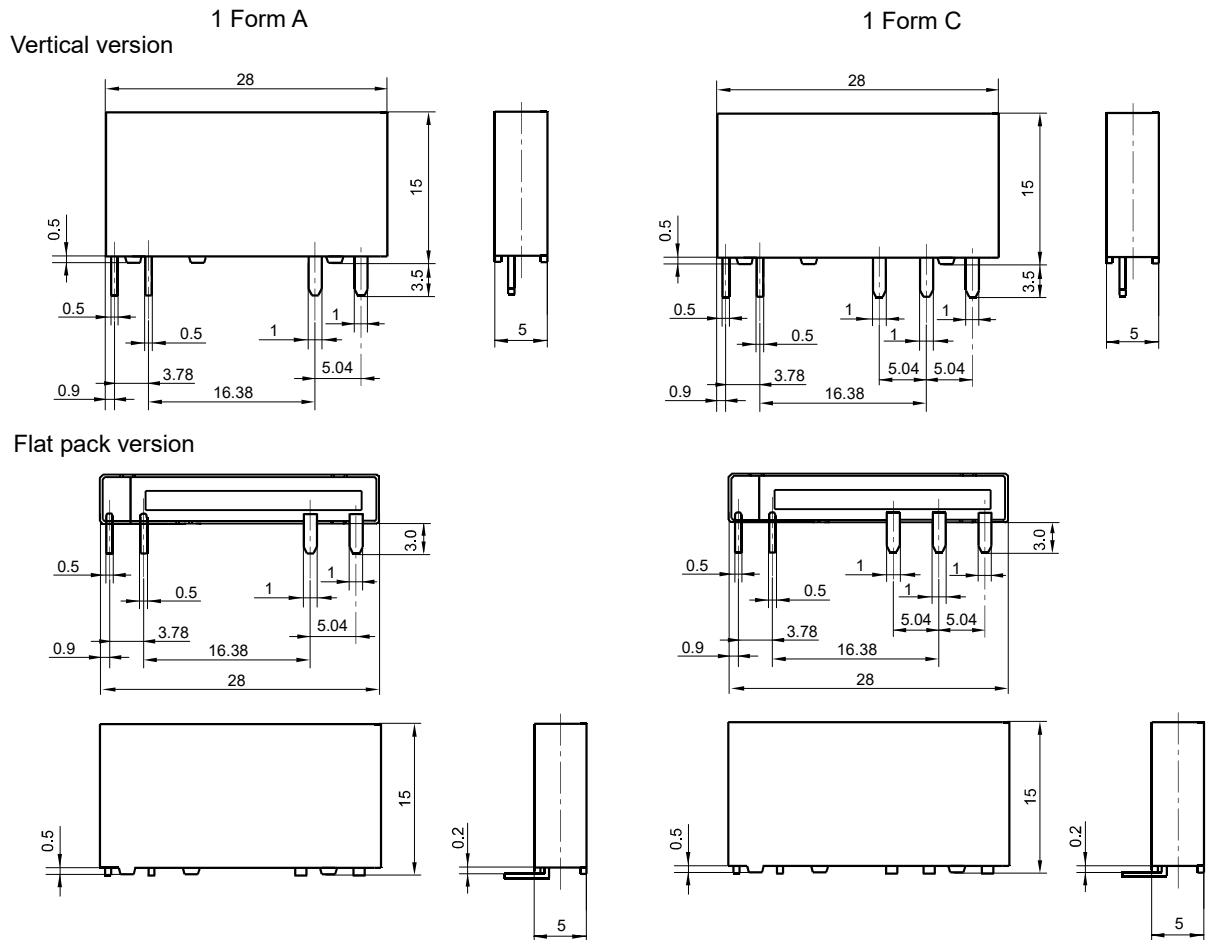

# OUTLINE DIMENSIONS, WIRING DIAGRAM AND PC BOARD LAYOUT

Unit: mm

## Outline Dimensions

1 Form A  
Special code: (414)

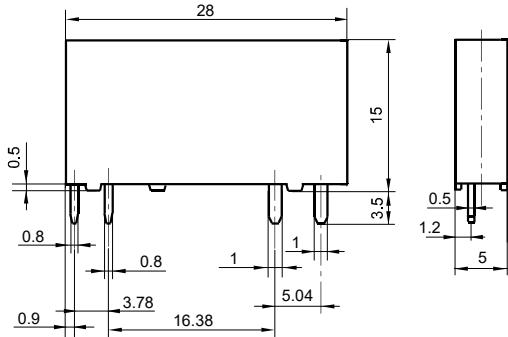

1 Form C

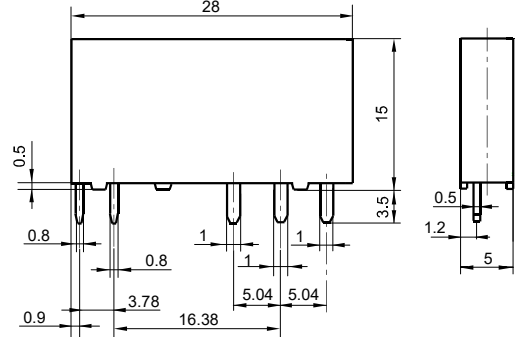

## PCB Layout (Bottom view)

1 Form A

Vertical version

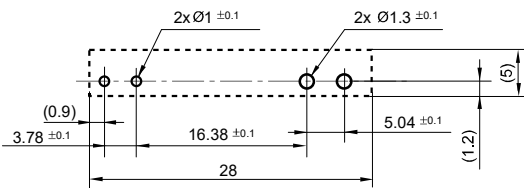

1 Form C

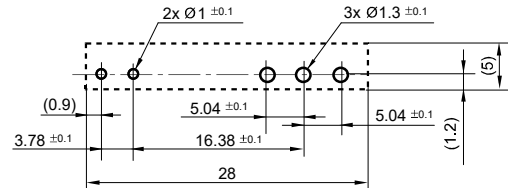

Flat pack version

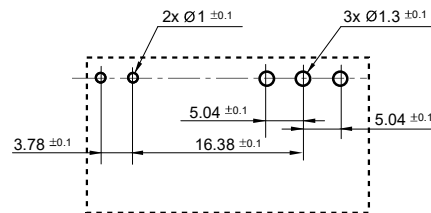
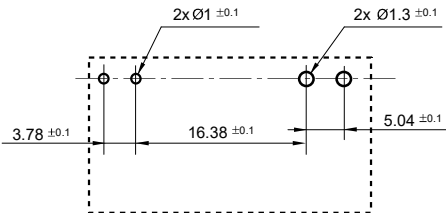

Special code: (414)

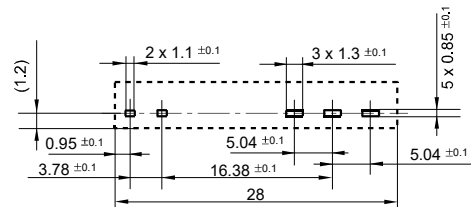
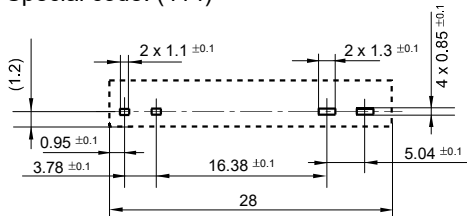

## Wiring Diagram (Bottom view)

1 Form A

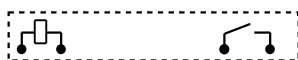

1 Form C

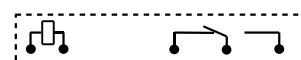

- Remark: 1) In case of no tolerance shown in outline dimension: outline dimension  $\leq 1\text{mm}$ , tolerance should be  $\pm 0.2\text{mm}$ ; outline dimension  $> 1\text{mm}$  and  $\leq 5\text{mm}$ , tolerance should be  $\pm 0.3\text{mm}$ ; outline dimension  $> 5\text{mm}$ , tolerance should be  $\pm 0.4\text{mm}$ .  
2) The tolerance without indicating for PCB layouts is always  $\pm 0.1\text{mm}$ .

## CHARACTERISTIC CURVES

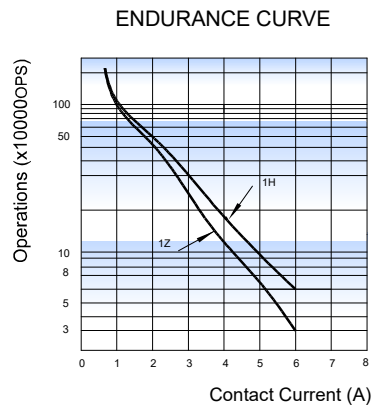
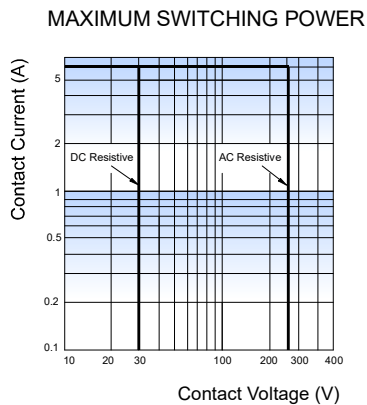

**Test conditions:**  
NO, AgNi, Resistive load, 250VAC,  
Flux proofed, Room temp., 1s on 9s off.

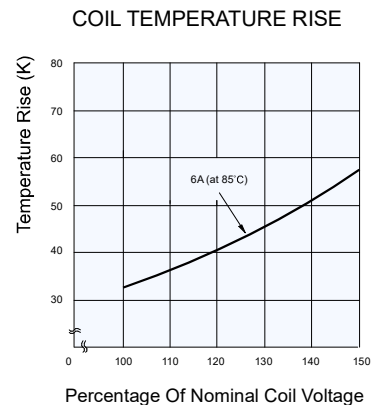

**Test conditions:**  
6A 85°C  
(Typical curve of 24VDC standard type)

## Relay Sockets

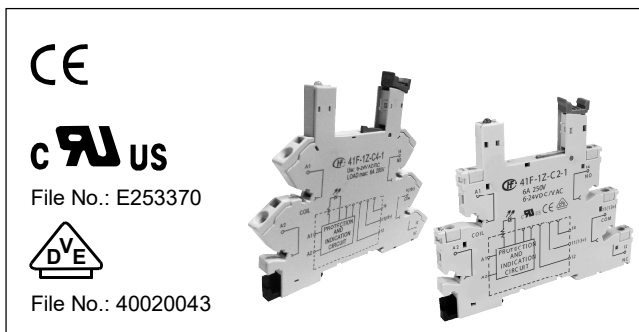

### Features

- The dielectric strength can reach 4000VAC and the insulation resistance is 1000MΩ
- With finger protection device
- Ensure secure retention and easy ejection of relays
- Built-in protection circuit can indicate the power status, protect the circuit and expand the range of relay input voltage
- Components available: marker, jumper and separator
- Environmental friendly product (RoHS compliant)



## CHARACTERISTICS

Type	Nominal Voltage	Nominal Current	Ambient Temperature	Input Voltage to Socket Coil	Relay Coil Voltage Applicable	Polarity of Input Voltage	Screw Torque	Wire Strip Length
41F-1Z-C2-1	250VAC	6A	-40 °C to 70 °C	(12 to 24)V AC/DC	(12 to 24)VDC	No requirement	0.5N · m	7mm
41F-1Z-C2-2	250VAC	6A	-40 °C to 70 °C	(48 to 60)V AC/DC	(48 to 60)VDC	No requirement	0.5N · m	7mm
41F-1Z-C2-3	250VAC	6A	-40 °C to 55 °C	(110 to 125)V AC/DC	60VDC	No requirement	0.5N · m	7mm
41F-1Z-C2-4	250VAC	6A	-40 °C to 55 °C	(220 to 240)V AC/DC	60VDC	No requirement	0.5N · m	7mm
41F-1Z-C2-5	250VAC	6A	-40 °C to 70 °C	(6 to 24)VDC	(6 to 24)VDC	Requirement	0.5N · m	7mm
41F-1Z-C4-1	250VAC	6A	-40 °C to 70 °C	(12 to 24)V AC/DC	(12 to 24)VDC	No requirement	-	7mm
41F-1Z-C4-2	250VAC	6A	-40 °C to 70 °C	(48 to 60)V AC/DC	(48 to 60)VDC	No requirement	-	7mm
41F-1Z-C4-3	250VAC	6A	-40 °C to 55 °C	(110 to 125)V AC/DC	60VDC	No requirement	-	7mm
41F-1Z-C4-4	250VAC	6A	-40 °C to 55 °C	(220 to 240)V AC/DC	60VDC	No requirement	-	7mm
41F-1Z-C4-5	250VAC	6A	-40 °C to 70 °C	(6 to 24)VDC	(6 to 24)VDC	Requirement	-	7mm
41F-1Z-A2-1	250VAC	6A	-40 °C to 70 °C	(6 to 24)V DC	(6 to 24)V DC	Requirement	-	-
41F-1Z-A2-2	250VAC	6A	-40 °C to 70 °C	(48 to 60)V DC	(48 to 60)V DC	Requirement	-	-

**Note:** When the 41F-1Z-C2/C4-1 socket is applied to the relay of 12VDC nominal voltage, the relay of which pick-up voltage =70% nominal voltage should be required and the special order of relay allowed. 41F-1Z-C2/C4-4 is not allowed in continuous electricity conditions.

# OUTLINE DIMENSIONS, WIRING DIAGRAM AND PC BOARD LAYOUT

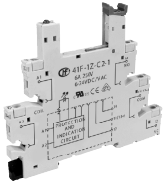
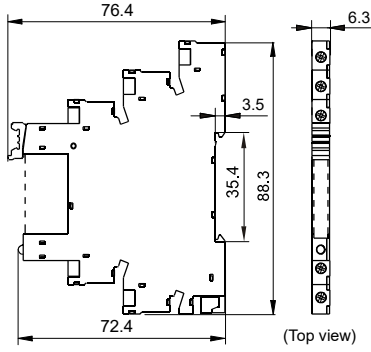
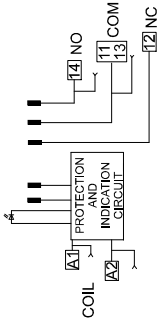
Unit: mm

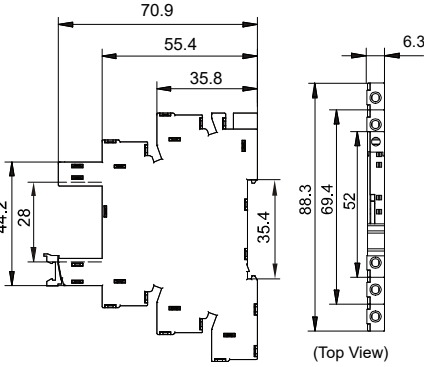
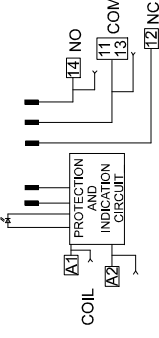
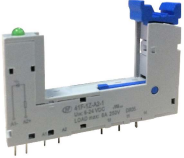
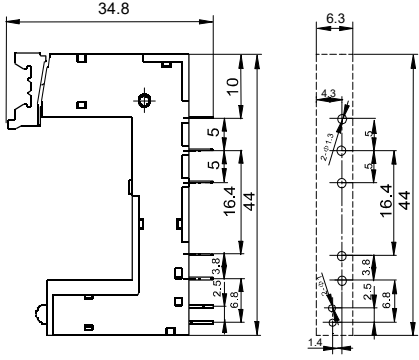
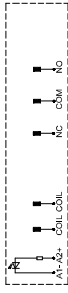
Socket	Outline Dimensions	Wiring Diagram	Components Available
<p>41F-1Z-C2-1/2/3/4/5</p>  <p>Screw terminal, DIN rail mounting, With finger protection device Certified by VDE and UL/CUL</p>	 <p>(Top view)</p>		<p>marker 41F-M 41F-M1</p> <p>jumper 41F-J1(blue) 41F-J1R(red) 41F-J1B(black)</p> <p>separator 41F-S</p>
<p>41F-1Z-C4-1/2/3/4/5</p>  <p>Spring-loaded terminal, DIN rail mounting, With finger protection device</p>	 <p>(Top View)</p>		<p>marker 41F-M 41F-M1</p> <p>jumper 41F-J1(blue) 41F-J1R(red) 41F-J1B(black)</p> <p>separator 41F-S</p>
<p>41F-1Z-A2-1/2</p>  <p>PCB terminal, PCB mounting</p>			<p>*marker 41F-M</p>

Notes: \* If need accessory, please order with type.

## DIMENSION OF RELATED COMPONENT (AVAILABLE)

Unit: mm

### Marker

41F-M

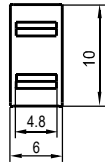

41F-M1

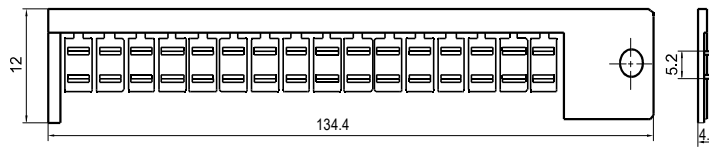

### Jumper

41F-J1(blue)、41F-J1R(red)、41F-J1B(black)



### Separator

41F-S

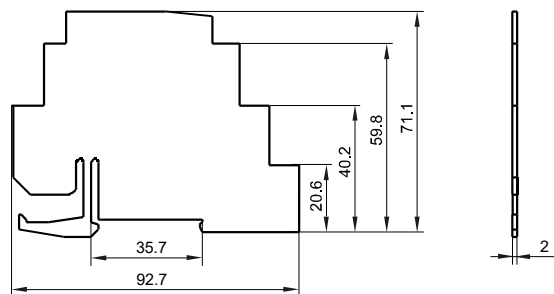

#### Things to be noticed when selecting sockets:

1. Please choose suitable relay socket according to the actual mounting environment, relay contact poles and terminal layout. If there is any query on selection, please contact Hongfa for the technical service.
2. As for related components, they should be selected separately. Please do give clear indication of the types of relay sockets and related components you choose while placing order.
3. The above is only an example of typical socket and related component type which is suitable to HF41F relay. If you have any special requirements, please contact us.
4. Main outline dimension > 50mm, tolerance should be  $\pm 1\text{mm}$ ; 20mm < outline dimension  $\leq 50\text{mm}$ , tolerance should be  $\pm 0.5\text{mm}$ ; 5mm < outline dimension  $\leq 20\text{mm}$ , tolerance should be  $\pm 0.4\text{mm}$ ; outline dimension  $\leq 5\text{mm}$ , tolerance should be  $\pm 0.3\text{mm}$ .
5. DIN rail mounting: recommend to use standard rail 35×7.5×1mm, 35×15×1mm.

## Precautions For Use

1. Please use the quick-break fuse with rating of 15Amp. for short-circuit protection.
2. It may cause failure, fire or malfunction, when the sockets is continuously applied the power to for a long term In case of exceeding the upper limit ambient temperature. So please ensure that the ambient temperature is within the upper limit when using sockets.

Operating temperature upper limit: 55°C: 41F-1Z-C2-3/4  
41F-1Z-C4-3/4

Operating temperature upper limit: 70°C: 41F-1Z-C2-1/2/5  
41F-1Z-C4-1/2/5

### 3. Things to be noticed when selecting soft wiring.

#### 1) 41F-1Z-C2-1/2/3/4/5

The soft wiring can be divided into the following types.

- Twisted line or single wire below 2.5mm<sup>2</sup> or below AGW14.
- Within 2 roots when the twisted below 1.5mm<sup>2</sup> or below AGW16.

Be sure to use this size that the front end of the wire needs to be stripped of the 7mm~8mm insulation protection layer. (Figure 1)

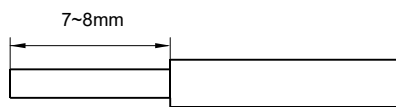

Figure 1

- Use the recommended screwdriver specifications when wiring.

Plus driver: Shaft Diameter  $\phi$  - 3.5mm.

Single driver: Figure 2.

- Recommended tightening torque: 0.5N·m

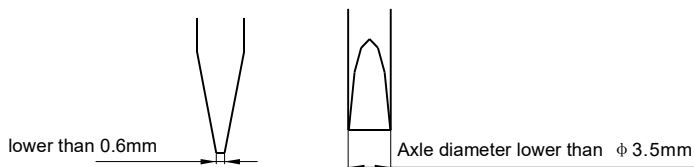

Figure 2.

#### b) 41F-1Z-C4-1/2/3/4/5

The soft wiring can be divided into the following types.

Twisted line or single wire greater than 0.5mm<sup>2</sup> or less than 2.5mm<sup>2</sup> or greater than AWG 20 and less than AWG14.

Be sure to use this size that the front end of the wire needs to be stripped of the 7mm~8mm insulation protection layer.

Use the recommended screwdriver specifications when wiring.

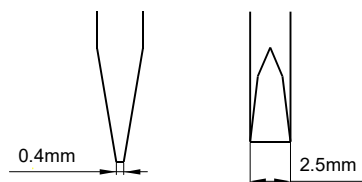

Figure 3.

## Precautions For Use

The insertion position of the wire and the screwdriver and the insertion direction of the screwdriver are as shown in Figure 4.

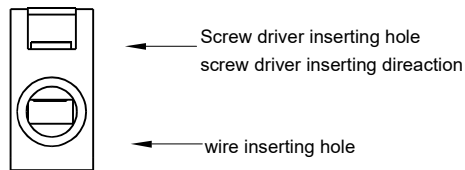

Figure 4

Please use cold pressed terminals when selecting twisted line.

The method of Wiring as shown in figure 5.

Step 1. Insert screwdriver into socket with screwdriver patchhole.

Step 2. Push the screwdriver in until it touches the stop position inside the socket, and keep the screwdriver in this position.

Step 3. Please keep the screwdriver in this position, and wires inserted into the terminal insertion hole bottom.

Step 4. Pull out the screwdriver and the wiring is completed.

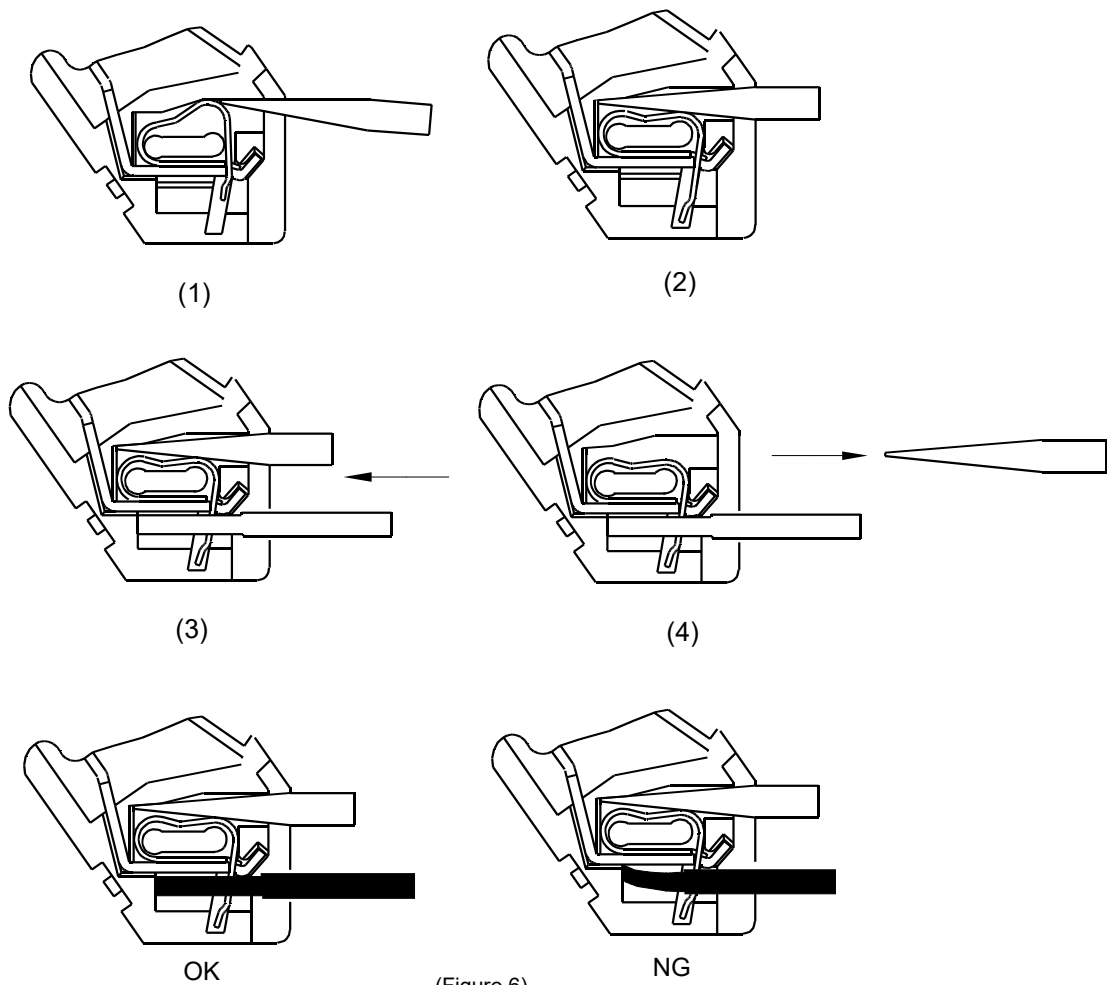

(Figure 6)

Do not insert the wire insulation.



## Precautions For Use

### 4. Mounting relay.

Presents the socket anti-stripping spring in an open state (see Figure 7), and aligns the relay to the main socket cavity (Figure 8). Then turn the buckle counterclockwise and press the relay gently until it is fully plugged into the socket (Figure 9).

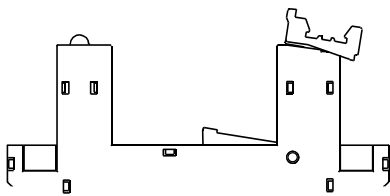

Figure 7

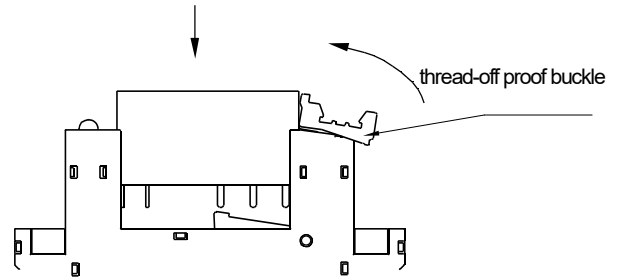

Figure 8

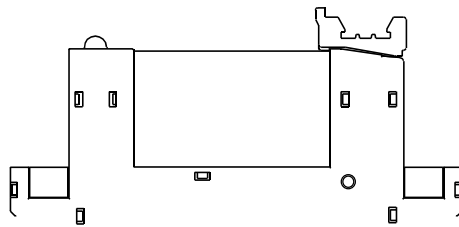
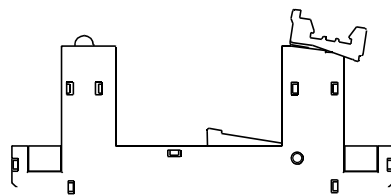
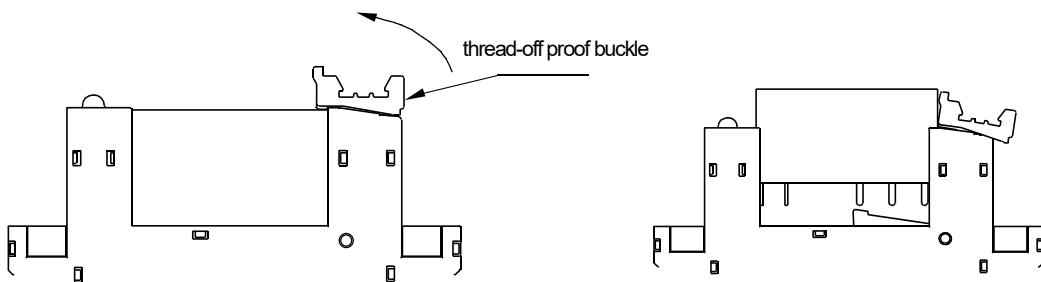

Figure 9

### 5. Disassembly relay.

Disconnect the relay by pulling the anti lock buckle of the socket clockwise (please refer to the pictures attached for more details)



## Precautions For Use

### 6. Installation socket.

Insert the A of the socket into the rail and press it in the direction of the arrow.(Figure 11)

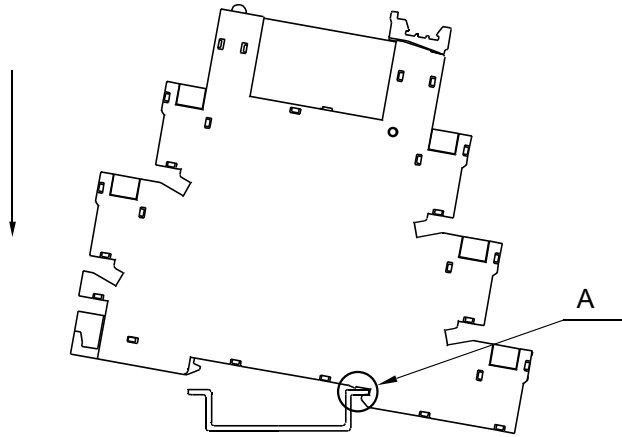

Figure 11

### 7. Disassembly socket.

Insert a screwdriver into B, turn in the direction of the arrow, lift the socket and remove the socket.(Figure 12)

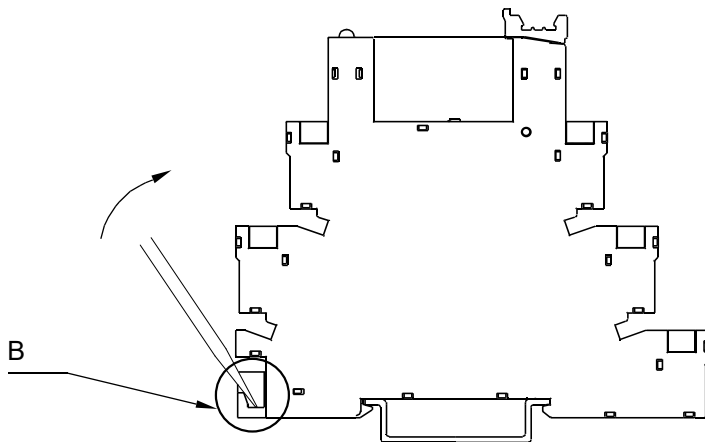

Figure 11

## Disclaimer

The specification is for reference only. See to "Terminology and Guidelines" for more information. Specifications subject to change without notice. We could not evaluate all the performance and all the parameters for every possible application. Thus the user should be in a right position to choose the suitable product for their own application. If there is any query, please contact Hongfa for the technical service. However, it is the user's responsibility to determine which product should be used only.

© Xiamen Hongfa Electroacoustic Co., Ltd. All rights of Hongfa are reserved.