

Product data sheet

Specifications



isolated analog input module X80 - 8 inputs - high speed

BMXAMI0810

Main

Range of product	Modicon X80
Product or component type	Analog input module
Electrical connection	28 ways 1 connector
Isolation between channels	Isolated
Input level	High level
Analogue input number	8
Analogue input type	Current +/- 20 mA Current 0...20 mA Current 4...20 mA Voltage +/- 10 V Voltage +/- 5 V Voltage 0...10 V Voltage 0...5 V Voltage 1...5 V

Complementary

Analog/Digital conversion	16 bits
Analogue input resolution	15 bits + sign
Permitted overload on inputs	+/- 30 mA 0...20 mA +/- 30 mA 4...20 mA +/- 30 V +/- 10 V +/- 30 V +/- 5 V +/- 30 V 0...10 V +/- 30 V 0...5 V +/- 30 V 1...5 V +/- 30 mA +/- 20 mA
Input impedance	10 MOhm in voltage mode 250 Ohm + 3.6...50 Ohm internal protective resistor in current mode
Precision of internal conversion resistor	0.1 % - 15 ppm/°C
Type of filter	First order digital filtering
Fast read cycle time	1 ms + 1 ms x number of channels used
Nominal read cycle time	9 ms for 8 channels
Measurement error	<= 0.1 % of full scale +/- 10 V 0...60 °C <= 0.1 % of full scale +/- 5 V 0...60 °C <= 0.1 % of full scale 0...10 V 0...60 °C <= 0.1 % of full scale 0...5 V 0...60 °C <= 0.1 % of full scale 1...5 V 0...60 °C <= 0.3 % of full scale +/- 20 mA 0...60 °C <= 0.3 % of full scale 0...20 mA 0...60 °C <= 0.3 % of full scale 4...20 mA 0...60 °C 0.15 % of full scale +/- 20 mA 25 °C 0.15 % of full scale 0...20 mA 25 °C

0.15 % of full scale 4...20 mA 25 °C
 0.075 % of full scale +/- 10 V 25 °C
 0.075 % of full scale 0...10 V 25 °C
 0.075 % of full scale 0...5 V 25 °C
 0.075 % of full scale 1...5 V 25 °C
 0.075 % of full scale +/- 5 V 25 °C

Temperature drift	30 ppm/°C +/- 10 V 30 ppm/°C +/- 5 V 30 ppm/°C 0...10 V 30 ppm/°C 0...5 V 30 ppm/°C 1...5 V 50 ppm/°C +/- 20 mA 50 ppm/°C 0...20 mA 50 ppm/°C 4...20 mA
Minimum crosstalk attenuation	80 dB
Common mode rejection	80 dB
Digital value format	- 32768 to + 32767 in maximum user scale +/- 10000 by default
Isolation voltage	300 V DC between channels 1400 V DC between channels and ground 1400 V DC between channels and bus
Measurement resolution	0.36 mV +/- 10 V 0.36 mV 0...10 V 0.36 mV 0...5 V 0.36 mV 1...5 V 0.36 mV +/- 5 V 1.4 µA +/- 20 mA 1.4 µA 0...20 mA 1.4 µA 4...20 mA
Maximum conversion value	+/- 11.4 V +/- 10 V +/- 11.4 V 0...10 V +/- 11.4 V 0...5 V +/- 11.4 V 1...5 V 0...30 mA +/- 20 mA 0...30 mA 0...20 mA 0...30 mA 4...20 mA 0...30 mA +/- 5 V
MTBF reliability	900000 H
Operating altitude	0...2000 m 2000...5000 m with derating factor
Status LED	1 LED (green) RUN 1 LED per channel (green) channel diagnostic 1 LED (red) ERR 1 LED (red) I/O
Net weight	0.165 kg
Power consumption in W	1.06 W 24 V DC typical 1.50 W 24 V DC maximum 0.32 W 3.3 V DC typical 0.48 W 3.3 V DC maximum

Environment

Vibration resistance	3 gn
Shock resistance	30 gn
Ambient air temperature for storage	-40...85 °C
Ambient air temperature for operation	0...60 °C
Relative humidity	5...95 % at 55 °C without condensation
IP degree of protection	IP20
Directives	2014/35/EU - low voltage directive 2014/30/EU - electromagnetic compatibility
Product certifications	CE RCM CSA EAC Merchant Navy UL
Standards	EN/IEC 61010-2-201

Packing Units

Unit Type of Package 1	PCE
Number of Units in Package 1	1
Package 1 Height	5.500 cm
Package 1 Width	11.000 cm
Package 1 Length	12.000 cm
Package 1 Weight	158.000 g
Unit Type of Package 2	S02
Number of Units in Package 2	15
Package 2 Height	15.000 cm
Package 2 Width	30.000 cm
Package 2 Length	40.000 cm
Package 2 Weight	2.740 kg
Unit Type of Package 3	P06
Number of Units in Package 3	240
Package 3 Height	75.000 cm
Package 3 Width	60.000 cm
Package 3 Length	80.000 cm
Package 3 Weight	49.000 kg

Offer Sustainability

Sustainable offer status	Green Premium product
REACH Regulation	REACH Declaration
REACH free of SVHC	Yes
EU RoHS Directive	Pro-active compliance (Product out of EU RoHS legal scope) EU RoHS Declaration
Mercury free	Yes
China RoHS Regulation	China RoHS declaration
RoHS exemption information	Yes
Environmental Disclosure	Product Environmental Profile
Circularity Profile	End of Life Information
WEEE	The product must be disposed on European Union markets following specific waste collection and never end up in rubbish bins
California proposition 65	WARNING: This product can expose you to chemicals including: Lead and lead compounds, which is known to the State of California to cause cancer and birth defects or other reproductive harm. For more information go to www.P65Warnings.ca.gov

Contractual warranty

Warranty	18 months
----------	-----------

Modules Mounted on Racks

Dimensions

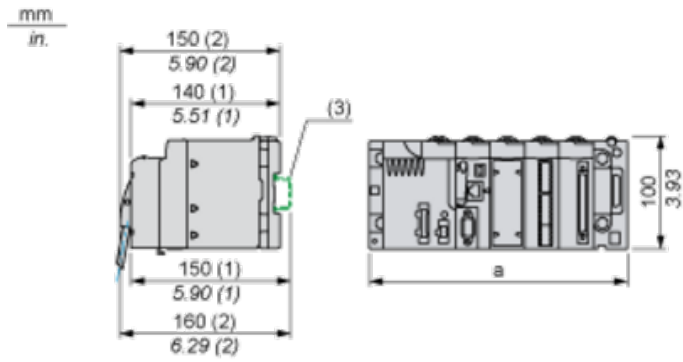

(1) With removable terminal block (cage, screw or spring).

(2) With FCN connector.

(3) On AM1 ED rail: 35 mm wide, 15 mm deep. Only possible with BMXXBP0400/0400H/0600/0600H/0800/0800H rack.

Rack references	a in mm	a in in.
BMXXBP0400 and BMXXBP0400H	242.4	09.54
BMXXBP0600 and BMXXBP0600H	307.6	12.11
BMXXBP0800 and BMXXBP0800H	372.8	14.68
BMXXBP1200 and BMXXBP1200H	503.2	19.81

Wiring Diagram

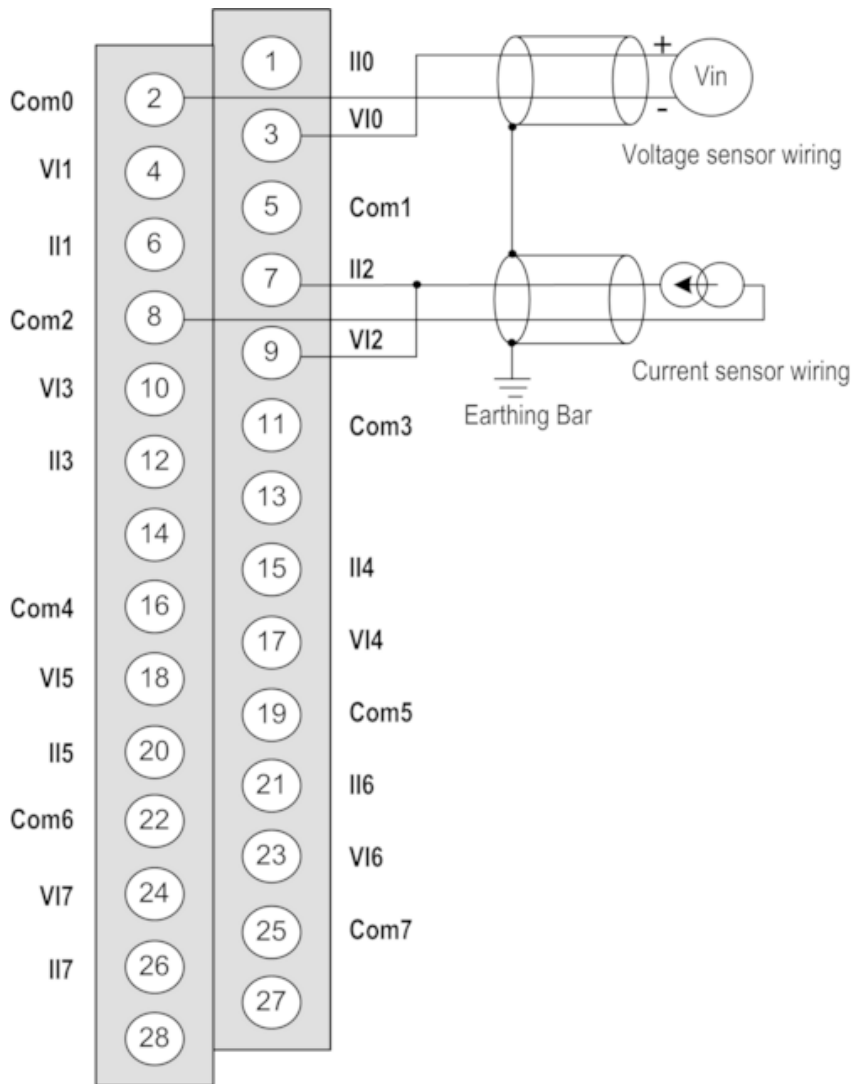

VIx + pole input for channel x
COM x - pole input for channel x
IIx current reading resistor + input
Channel 0 voltage sensor
Channel 1 2-wire current sensor

Recommended replacement(s)