

## KDP-Q81F USER MANUAL

# Hands-Free Doorphone

- Calling to & Phone call with sub-unit at the entrance
- Phone calling and door opening
- Connection with doorlock by AC or DC type
- LED brightness control for checking operating status
- Doorphones extension upto 4 units
- Mutual beeping & calling through doorphones

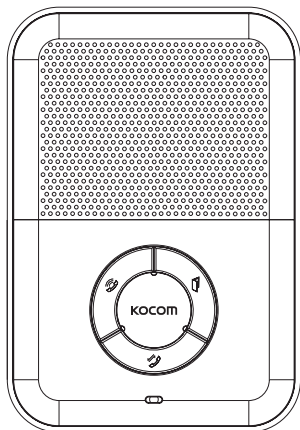

KDP-Q81F

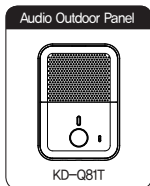

Thank you very much for purchasing KOCOM Doorphone. Please read this manual thoroughly to ensure correct usage, before operation.



# Table of Contents

Cautions for Safety .....	3~4
Product Configuration & Specifications .....	5
How to Install .....	6
Name and Functions of Each Part .....	7
Product Connection Diagram / System Diagram .....	8 ~ 9
How to Use .....	10 ~ 12

# Cautions for Safety

For safe use, please stick to the following cautions.

- Please save this manual after reading these instructions carefully.
- This Cautions for Safety may include items that are not contained in specifications of the product that consumer purchases.
- If you need assistance with the set-up or operation, please contact with A/S center.
- Read and understand all instructions to set up rightly.

## The important marks in the manual.

To help our customers to understand this manual, to prevent any personal injury or property damage, some marks are used in the manual. The marks and the drawing signs are below. Please understand the marks before reading the manual.

## The meaning of the drawing signs.

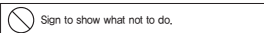

Sign to show what not to do.



Mishandling the device with ignoring this sign may result in serious injury or death.



Mishandling the device with ignoring this sign may result physical injury or material damage.



Sign to tell you that you should follow the instructions.



Sign to tell you that you need more attention including (high voltages, electric shock, danger, warning)



Sign to tell you that you can't disassemble this unit.



Sign to tell you that you must unplug the unit.



## Caution

### ▶ Cautions for set-up

- The law limits distributing the power lines to an authorized person from government. The work from an unauthorized person cause fire or electric shock.
- Place this unit securely on a stable surface. Serious damage and/or injury may result if the unit falls.
- Do not set up this unit near the leaking place because it may expose you to dangerous voltages or other risks.
- Even if your product is water proof, do not install it slanted place of water leakage, which can a short circuit.
- Fix the product on the wall safely according to the installation guideline to prevent any damage or injury.
- Don't put any stuff in 30cm around the monitor, not to block the air hole.
- The work of distributing wires needs skills and experiences. So please, for assistance, contact your dealer or call service center.
- The communication lines should be built in being distant from the power source. This may result in the risk of fire, electric shock and communication disorder.
- Setting the communication lines in a high humid place such as outside without any protection from rain causes the communication disorder.
- Keep the hook at the wall-mounted device safe. The hook may cause the physical injury.
- Think about the thickness and quality of wall material. The unqualified material may make the device fall.



- Set the device of the wall-mounted type not to fall. Falling from an earthquake causes personal injury.

### ▶ Cautions for Repairs and Maintenance



- Keep the inside of the device clean. Having the dust inside without any cleaning for a long time causes the fire. If necessary, contact your dealer or service center to get cleaning service.



- Unplug this device when you want to check the inside. If there is no plug, please, turn off the circuit breaker.
- Unplug this device when you try to move it to another place. If the electric line is connected inside of the unit, please contact your dealer or service center.



- Do not use liquid or aerosol cleaners. Use a damp cloth for cleaning.



## Warning

### ▶ Warnings for Usage

- Do not install this unit near the water and dust, for example, in a bathroom or near the washing machine. It caused fire and electric shock.
- Do not install this unit near the fire, for example, near kitchen sink, heater or the like.
- Do not install near the noxious gas such as Hydrogen Sulfide, metal power and the like.
- Do not install near the water and chemicals.
- Do not give any damage, break and modify the plug. Overloading, heating, pulling causes the damage.
- Do not place the plug near the heater. The damaged code causes fire and electric shock. Do not pull the power code when unplugging.
- The damaged code causes fire and electric shock. Must pull with plug. Do not touch with wet hands. It causes the electric shock.
- Do not use any other voltage, except the marked regular voltage.
- Do not use the power terminal at the units to other electric device except the designed device.
- Do not install the units at the leaking place if it doesn't have any waterproof mark. Do not install the unit when the power is on.
- Install the circuit breaker after checking the safety such as electric shock and leakage. Turn off the power before you install or A/S
- Check the suitability of the lines for installing when you use the exiting lines.
- Do the wiring work by using the designed material.
- Connect the electric wire with the designed ways and ground.
- Do not connect with any other devices except the designed devices to compose the system.
- Unplug electric wire and communication lines from the units before moving to another place.

### ▶ Cautions for Use

- This unit is not designed for security purpose. - Do not handle the unit with the wet hands.
- Do not place a pot with water or a small metal material on the Units.
- Do not cover the ventilating opening or put any metal material in the units.
- During thunderstorms, avoid using this unit. There may be a remote risk of an electric shock from lightning.
- Do not modify the unit. - Open the main gate after checking ID if the image and sound system do not work. Call A/S



- Do not disassemble the back and cabinet cover.

### ▶ Cautions for Abnormality



- Change the damaged electric code.
- Unplug this unit from plug socket and refer servicing to an authorized service center when the following conditions occur:
  - If liquid has been spilled into the unit. - If the unit does not work normally by following the operating instructions.
  - If the unit exhibits a distinct change in performance. - If the unit has been dropped or physically damaged.
- The mains plug, as a disconnection device, shall remain readily accessible by the user.

## Caution

### ▶ Safety Instructions, Warnings and Cautions of Each System

- Do not disassemble this unit at will as this device is composed by precision parts. - Install the unit by following the set-up instructions of Kocom.
- Do not touch or insert any foreign substances, for example, sticker, magnetic, opener and the like.
- Make U-type at the end of wires as the rain can effect on the system by following the wires during the rainy season.

### ▶ Videophone

- Separate the AC/DC lines with the hook of the wall-mounted type when installing. - Connect the lines after peeling the wires properly.
- Do not distribute signal line with AC line. - Use the designed driver to connect the lines to terminal.
- Do not clean the LCD with the damp cloth for cleaning. Use the only dry and soft cloth. - Do not install the main gate monitor at the leaking place.

### ▶ MUST NOTE

- This product is designed as a home videophone and cannot use continuously like monitor camera.
- If there is temperature difference between inner part of camera and surrounding, dew condensation occurs on camera lens and may disturb image. If dew condensation is removed from camera lens, image quality recovers.
- While LED light examination range is narrower than camera shot range at night, so there is less amount of light at night than day. So it is difficult to see the face in low illumination condition due to noise increase on screen, but it is not from defect.
- Monitor screen (liquid crystal panel) is not in defect when some pixels alternate light or black out.
- Please install monitor and camera over 5cm away.
- Also, avoid installing at a place with too much noise, because too much noise around camera causes phone call inferiority.
- Do not place an object within 20cm in front of monitor. It causes phone call inferiority, especially because microphone is installed at the top of monitor.
- If strong light such as sunlight flows into camera module, screen saturation (or strange mark) and image shaking might occur.
- This is not a defect, so please do not install camera where a direct ray of light do not flow if possible.

### ▶ Cautions

- In some cases there is occurrence of product destruction, malfunction, noise mixing and picture quality deterioration due to mixing of other tools induced, voltage or thunder with communication wiring of monitor/camera, monitor/extended monitor. Do not wire with power line such as outdoor wiring or AC power, or phones and other tools.
- You cannot use it if you incorrectly wire the AC voltage between monitor/camera, monitor/extended monitor. Call the store or agency where you purchased this product and consult to solve the problem. Beware that unfixable damage might be caused due to authorizing AC voltage on communication wiring of monitor/camera, monitor/extended monitor.
- Do not ever disjoin this product. It may cause electrocution accident when touching high-voltage circuit inside this product.
- Outside power authorizing this product must be confirmed of product description and use rated voltage. Beware that if higher voltage is authorized, unfixable damage might be caused due to product destruction.
- Power must be connected to domestic voltage (product rated voltage) consent or interior wiring. If connected to other motive power or inverter-type power, product destruction, noise mixing, and picture distortion may occur.
- Do not drop this product. Glass is used for monitor and might break, or cause other circuit inferiority. In such case, immediately turn down the power switch, and call to consult agency or store in which this product was purchased.
- Keep away from any conditions where water splatters or falls. Do not place anything containing water like a vase on the product.
- If installed near transmission antenna such as broadcasting station, electric wave may mix and cause picture distortion or voice mixing.
- Avoid installing near tools with strong electromagnetic waves such as microwaves and cell phones, or it may cause picture distortion.
- Do not install monitor in following places.
  - ① Above or around water heater, rice-cooker, heater
  - ② Place exposed to direct rays of the sun
  - ③ Place with temperature below 0°C such as cold store
  - ④ Place with high humidity such as bathroom, washroom, heated room
  - ⑤ Place with a lot of gas, dust, smoke
  - ⑥ Dangerous place with sprays of water or chemicals
- Do not wipe with insecticide, drugs or chemicals such as thinner and alcohol, or it may damage the surface of this product.
- Beware of occurrence of image quality deterioration or malfunction from cause of humidity due to penetration of chemicals or water into camera's urea resins.
- As in the picture, it prevents temperature difference of camera (outside) and monitor (inside), and removes dew condensation caused by humidity of camera window.
- Camera must be installed when wall cement is completely dry.
- When product is installed in winter below -5°C, wait for approximately 2 hours to connect. Dew formation in monitor and camera due to temperature difference inside and outside may cause product defect.
- Avoid installing monitor and camera in place directly exposed to heat or where gas noxiousness is highly occurring.

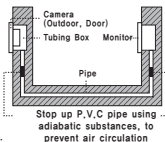

## Product Configuration

### ■ Doorphone configuration (Main unit)

· Doorphone

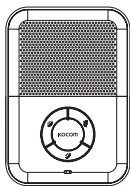

· Doorphone dummy case

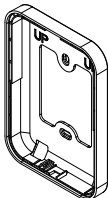

· Doorphone fixing screws  
 3 X 8mm (1ea)

· Screws for fixing main body on thr wall



FTS#8 X 50mm (2ea)

· Wiring for 2P door opener (1ea)



· 4P Audio outdoor panel wiring for connection



· Power (AC 220V) supply connector wiring

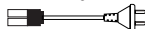

### ■ Audio outdoor panel (KD-Q81T) configuration (Sub unit)

· Audio outdoor panel

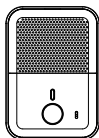

· Audio outdoor panel dummy case

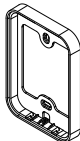

· Audio outdoor panel screws for fixing main body on the wall



FTS#8 X 50mm (2ea)

· Audio outdoor panel fixing screws



3 X 8mm (1ea)

## Product Specifications

### ■ Doorphone component (main unit)

Model no.	KDP-Q81F
Power source	100-240V~, 50/60Hz
Power consumption	Stand by 1.3W, Max 4.0W
Operating temperature	0°C ~ +40°C
Communication system	Hands-free type
Wiring	Audio outdoor panel : polarized 3 wire Door open : non-polarized 2 wire/ (power separate)
Mount type	Surface mount
Dimension	119(W) × 170(H) × 30(D) mm

### ■ Audio outdoor panel component (sub unit)

Model no.	KD-Q81T
Power source	DC 12±2V  (Supply from the main unit)
Power consumption	2W
Operating temperature	-10°C ~ +50°C
Mount type	Surface mount
Dimension	94(W) × 134(H) × 21.5(D) mm

## How to Install

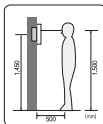

### ■ Main unit installation location

- Standard installation height is about 1,500mm where the unit is at eye level. In this case, wall-hanging metal center (center of piping) is 1,450mm above ground level.
- Standard installation height

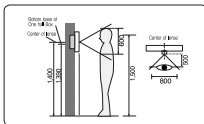

### ■ Sub unit installation location

- Sub unit installation in height standard sub unit installation height is when the unit is about 1,400mm above the floor. In this case, the dummy case is above 1,390mm above ground level.
- Standard installation in height

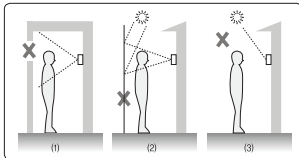

### ■ Caution of sub unit installation

- Avoid installing sub unit exposed to direct ray of light (and sun).
- Beware backlight and darkness of visitor's face, which makes identification difficult.
- Avoid installing sub unit in places such as the following picture.
  - (1) Place illuminating sky as background
  - (2) Place with white wall reflecting direct ray of light
  - (3) Place with direct ray of light
- Standard installation in height

## ■ Doorphone installation

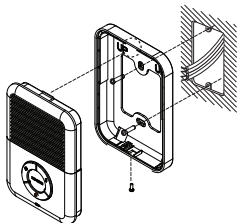

### ■ Directly connecting cut-off power cord with power wire

- 1) Do not do such electric work on your own. Installing product in this way requires reliance on electric installation man with electric work license.
- 2) Insulate with insulating tape while cutting off power cord and connecting with power wire so electric wire metal does not expose. Contact between exposed electric wires cause fire or electric shock accident.
- 3) Such electric work requires connection after interception of supplied power.

- 1) Remove wall-hanger bracket metal behind doorphone.
- 2) Install wall-hanger bracket metal on I type box or wall with attached screws.
- 3) Connect wiring to monitor back terminal referring to product connection diagram.
- 4) Hang monitor on wall-hanging metal, and fix doorphone on wall-hanger bracket metal using attached screws.

## ■ Audio outdoor panel installation

[KD-Q81T/Surface mount]

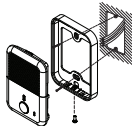

- 1) Install audio outdoor panel dummy case with screws for main body on the wall.
- 2) Connect wiring to audio outdoor panel terminal referring to product connection diagram.
- 3) Hang audio outdoor panel on wall-hanging metal, and fix monitor on wall-hanger bracket metal using attached screws.

## Name and Functions of Each Part

· Doorphone (Front)

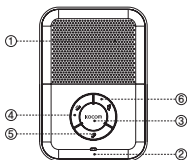

· Doorphone (Back)

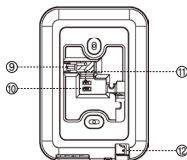

· Doorphone (Bottom)



- ① Speaker
- ② Mic
- ③ Power/Show motion sensor LED
- ④ A front door magnetic button
- ⑤ Extension button / Paging button
- ⑥ Open door & Menu button
- ⑦ Call volume three stage variable switch
- ⑧ Pager volume three stage variable switch
- ⑨ AC/DC Switch connection terminal
- ⑩ A front door magnetic connection terminal
- ⑪ Upgrade terminal
- ⑫ AC Power wiring connection jack

· Audio outdoor panel (Front)

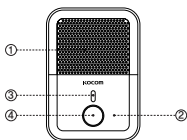

· Audio outdoor panel (Back)

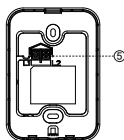

- ① Speaker
- ② Mic
- ③ Power/Show motion sensor LED
- ④ Call button
- ⑤ Doorphone connection wiring

## Product Connection Diagram

※ Please follow below diagram to complete the wiring connection and then turn the unit on, and then check the operating condition.

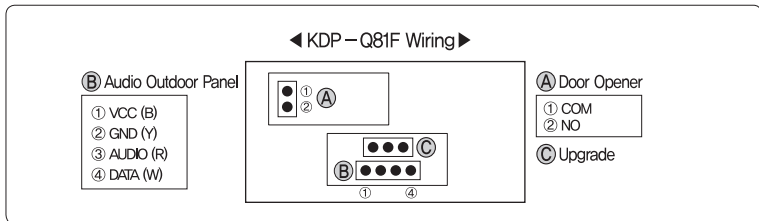

## System Diagram

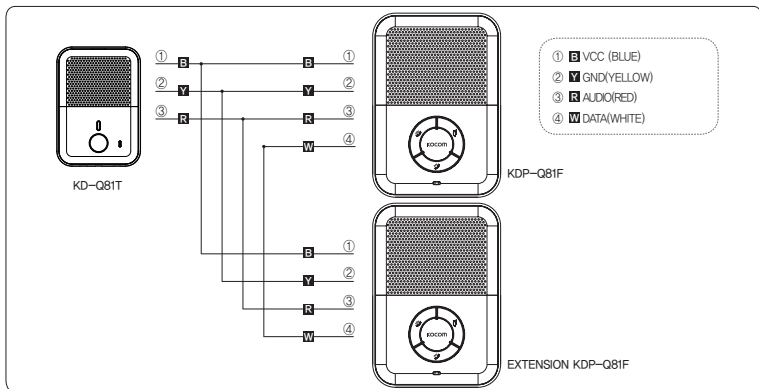
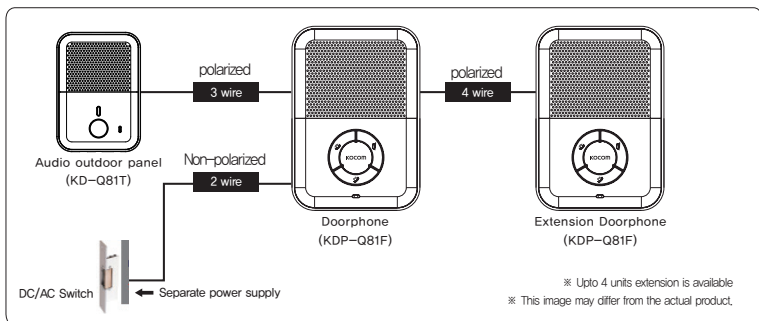



## System Diagram

### ■ Doorphone → Audio outdoor panel 1:1

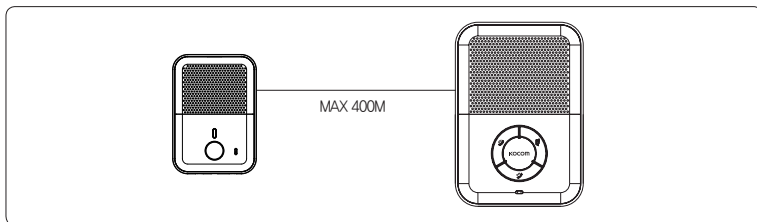

### ■ Doorphone → Audio outdoor panel 4:1

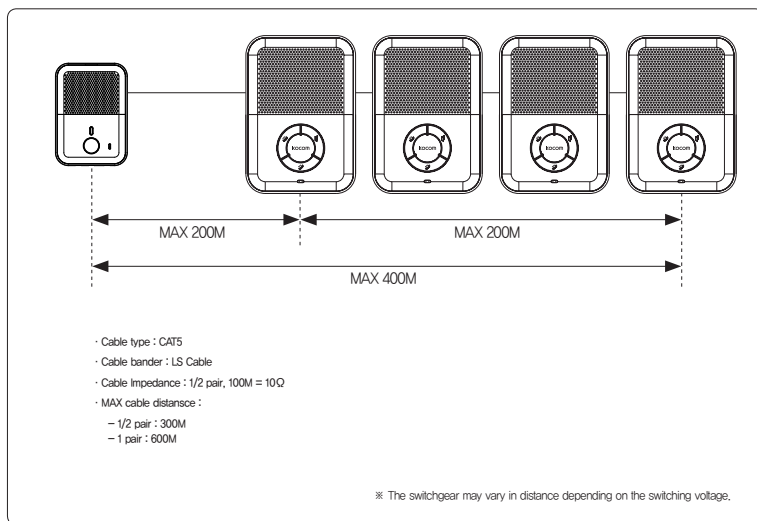

## Button Function

### ■ Button function

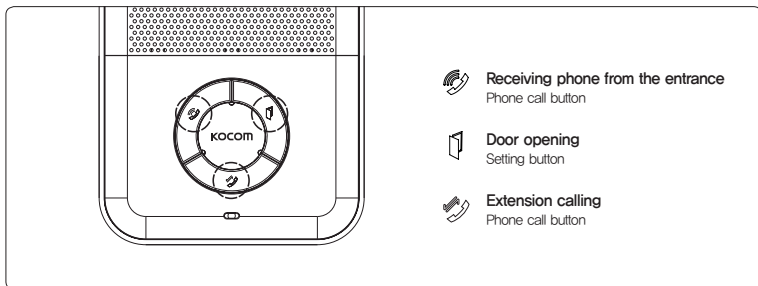

### ■ LED status description

Waiting : A weak light

Audio outdoor panel front door call : bright slow flashing

When calling to lobby or extension : A bright light

When paging extension : bright fast flashing

## How to Use

### ■ Booting

When power is on, certain different type of booting sound according to each different version of the unit will come out.

### ■ When a visitor called from the lobby through sub-unit

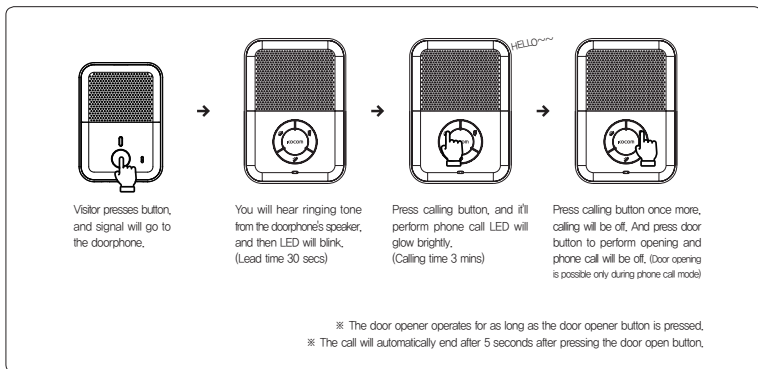

## How to Use

### ■ When calling directly from doorphone to sub-unit (KD-Q81T) at the entrance

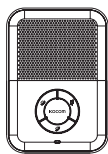

On standby,

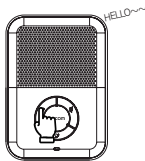

When pressing phone call button during standby, LED will glow brightly. (Calling time 3 mins)

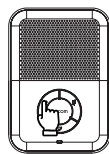

Press calling button once more, calling will be off.

※ When extending multiple doorphones at once (upto 4 units) and then one of them gets a calling from the entrance, the rest will be off.

### ■ When calling to the housing

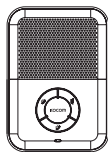

When pressing extension button during standby, you'll hear ringing tone and LED will blink quickly. (Calling time 30 secs)

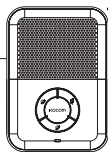

You'll hear ringing tone from the another doorphone which is in connection, and LED will blink quickly. (Calling time 30 secs)

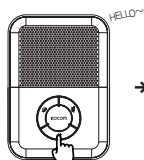

Press extension button or call button from the another doorphone which is in connection, and phone call is available. Then LED will glow brightly. (Calling time 30 secs)

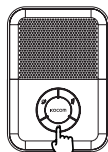

During extension calling status, press call button or extension button then phone call will be off.

※ When extending multiple doorphones at once (upto 4 units) and then one of them gets a extension calling, the rest will be off.

### ■ Paging functions

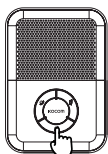

Press extension button for more than 1 sec during standby status you will hear beeping sound and the phone call to those connected doorphones can be available. LED will glow brightly.

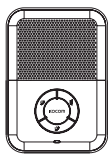

All connected doorphones will ring and automatic phone call will be accessed. LED will glow brightly.

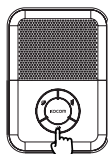

※ During extension calling or phone call, existing operation will be automatically off and then you can perform paging function.





## Warranty

▶ To receive after service, have the following ready before you contact our branches.

1. Name of the product.
2. Model number of the product.
3. The area of problem.
4. Phone number and address at which you can be contacted.

## Warranty Card

PRODUCT	
MODEL	KDP-Q81F
DATE PURCHASED	
WARRANTY PERIOD	
AGENCY ADDRESS	

▶ KOCOM Warranties the original purchaser of this product as follows.

- 1) This product is produced under strict quality control and inspection procedures.
- 2) If this product breaks down during proper use as a result of product defect, KOCOM will repair it within one year from date of purchase free of charge.
- 3) The following cases will be subject to charge, even during warranty period:
  - a. Breakdown during transport, or through careless treatment, by consumer.
  - b. Breakdown cause by unauthorized repair, or system modification.
  - c. Breakdown caused by natural disaster or power disorder.

**KOCOM CO.,LTD.** [www.kocom.com](http://www.kocom.com)

This manual is based on the date as shown in the right and specifications are subject to change without notice for quality improvement

KDP-Q81F

T1021