

brother

TZ
TAPE

P-touch

ELECTRONIC LABELING SYSTEM

***PT-H110* User's Guide**

English

brother

TZe
TAPE

P-touch

ELECTRONIC LABELING SYSTEM

PT-H110 User's Guide

English

With your new Brother P-touch label maker, you can create a wide variety of custom, self-adhesive labels. This label maker uses Brother "TZe" tapes from 0.13" (3.5mm) to 0.47" (12mm) widths. "TZe" tape cassettes are available in many colors and sizes. Visit www.brother.com for a complete list of tapes that work with your machine. Read this manual carefully before starting and keep it in a handy place for future reference.

Printed in China
LAJ575001



1 GETTING STARTED

Power Supply and Tape Cassette

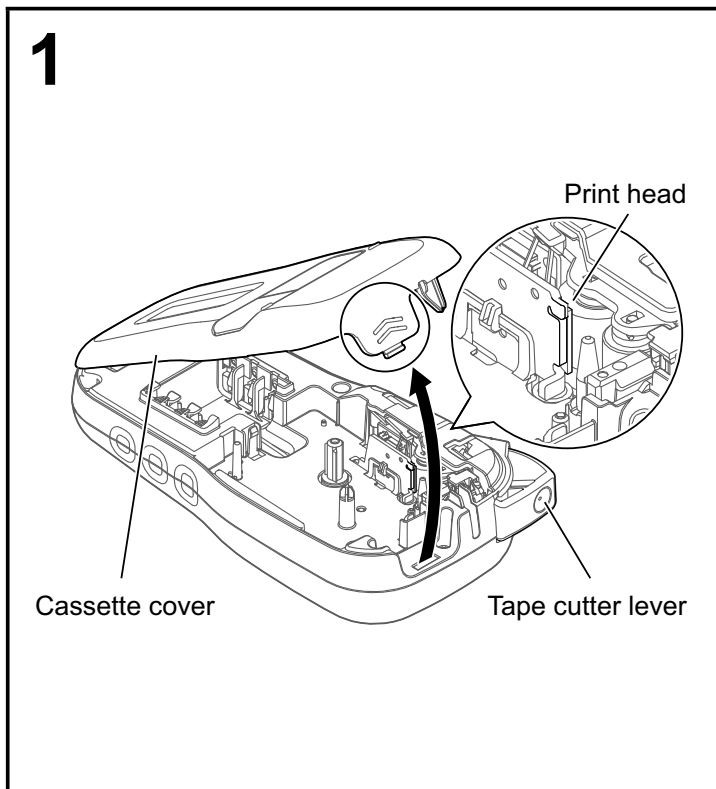

Open the cassette cover by pressing the above indicated area at the top end of the label maker.

- Make sure you turn off the power when replacing batteries or tape cassettes.

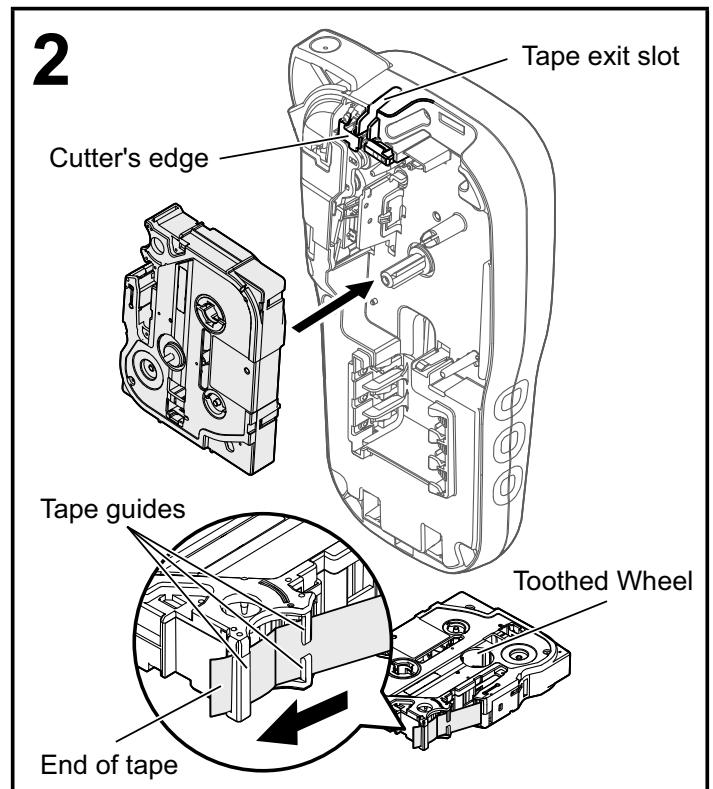

Insert a tape cassette, making sure it snaps into place.

- Make sure the end of the tape feeds under the tape guides.
- Use Genuine Brother P-touch TZe tapes with this label maker.

NOTE

When using optional AC adapter (AD-24ESA)

1. Insert the plug on the adapter cord into the AC adapter jack on the bottom end of the label maker.
2. Insert the plug into the nearest standard electrical outlet.
For memory backup, use either AAA alkaline batteries (LR03) or Ni-MH batteries (HR03) together when using the AC adapter.

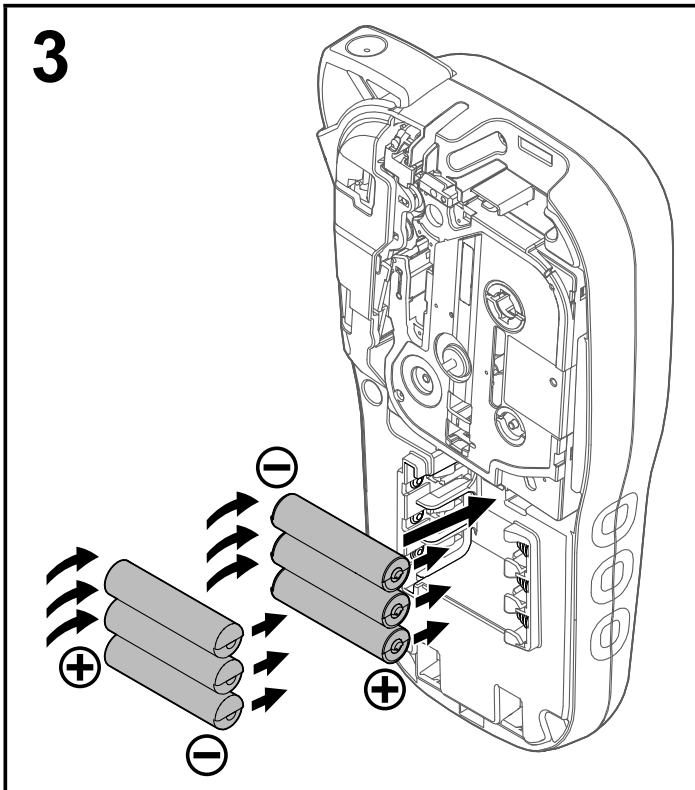

3 Insert six new AAA alkaline batteries (LR03) or fully charged Ni-MH batteries (HR03), making sure their poles point in the correct directions. Users of alkaline batteries: Always replace all six batteries at the same time with brand new ones. Users of Ni-MH batteries: Always replace all six batteries at the same time with fully charged ones.

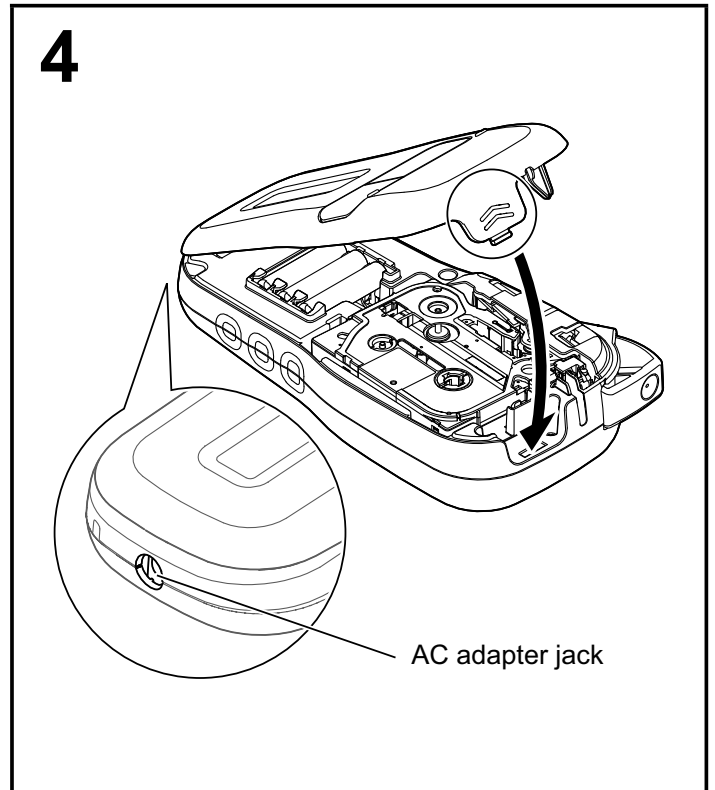

- 1** Insert the two hooks at the bottom of the cassette cover into the slots on the label maker.
- 2** Securely close the cassette cover making sure it snaps into place.

LCD

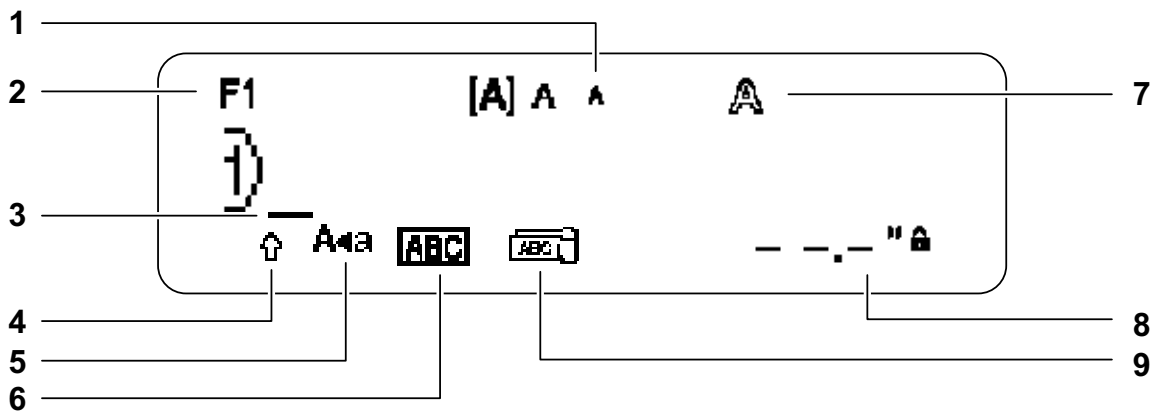

- | | | |
|-----------|--------------------|--------------------------------|
| 1. Size | 5. Caps | 8. Label Length |
| 2. Font | 6. Underline/Frame | If a specific label length has |
| 3. Cursor | 7. Style | been selected, also appears. |
| 4. Shift | | 9. Cable |

NOTE

- The LCD displays one row of 15 characters; however, the text you enter can be up to 80 characters in length.

- Label length displayed on LCD may differ slightly from the actual label length when printed.

Initial Settings

1 Turn on your label maker.

Supply power using six AAA batteries or the optional AC adapter (AD-24ESA), and then press to turn the power on.

2 Set the language.

The default setting is [English].

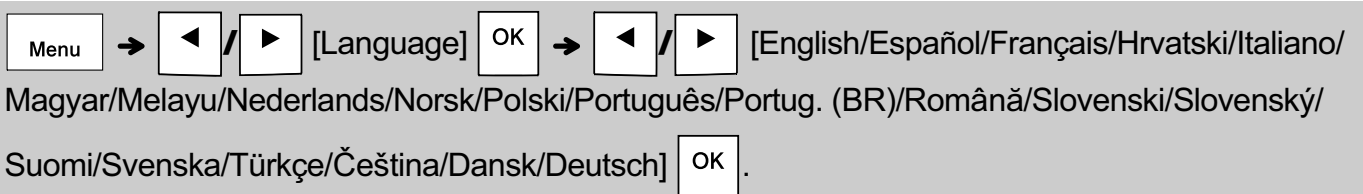

3 Set the unit of measurement.

The default setting is [inch].



NOTE

- The label maker automatically turns off if no keys are pressed within five minutes.
- To cancel any operation, press .
- After pressing , "Accepted" is displayed for approximately one second.

Keyboard

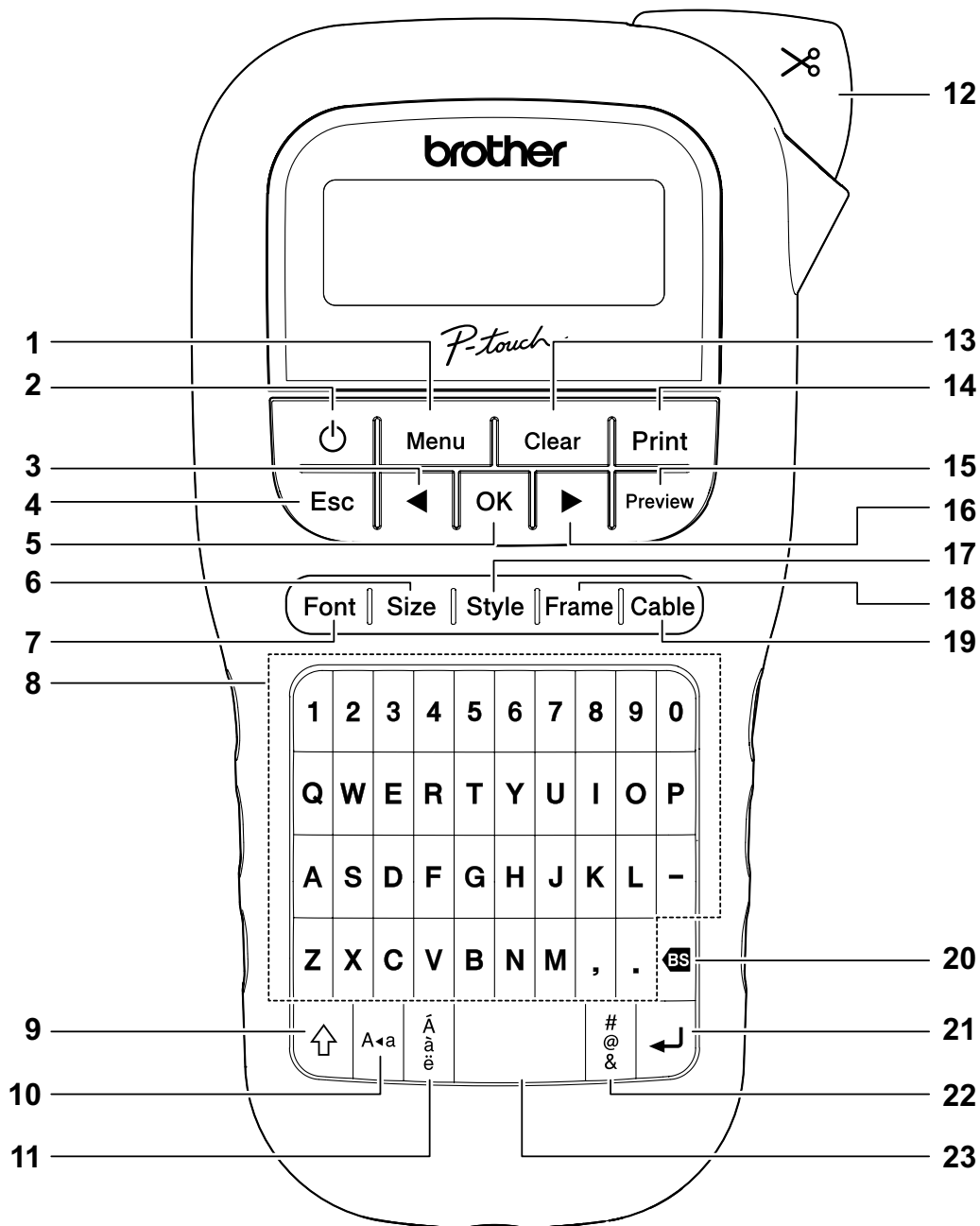

- | | | |
|---|---|-------------------|
| 1. Menu key | 9. Shift key | 17. Style key |
| 2. Power key | 10. Caps key | 18. Frame key |
| 3. Cursor key : Left (Use with Shift key to go to top of the text.) | 11. Accent key | 19. Cable key |
| 4. Escape key | 12. Tape cutter lever | 20. Backspace key |
| 5. OK key | 13. Clear key | 21. Enter key |
| 6. Size key | 14. Print key | 22. Symbol key |
| 7. Font key | 15. Preview key | 23. Space key |
| 8. Character key | 16. Cursor key : Right (Use with Shift key to go to end of the text.) | |

NOTE

- While selecting the settings, press the Space key to revert to the default item.

- Pressing the Preview key displays a generated image of the label, and may differ from the actual label when printed.

1 GETTING STARTED (Continued)

Contrast

This function allows you to set the brightness of the LCD. You can select from five levels of brightness.

The default setting is [0].

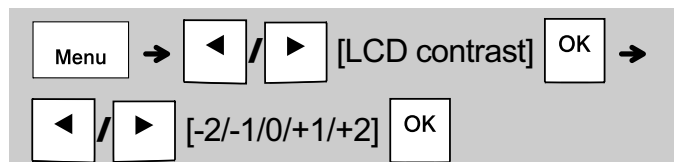

- To change back to default setting, press the Space key.
- After pressing [OK], "Accepted" is displayed for approximately one second.

2 BASIC USAGE

Entering Text

► Switching Upper Case/Lower Case



Press [A+a] to switch between upper and lower case text.

Upper case ([A+a] ON) Lower case ([A+a] OFF)

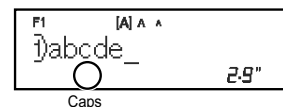
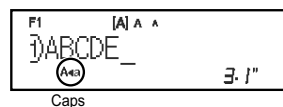

► Creating Two-Line Labels

Move the cursor to where you want to start the next line and press [Enter]. Use either 0.35" (9mm) or 0.47" (12mm) wide tape for two line printing.

Line 1

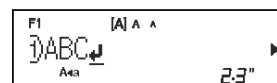

Label image

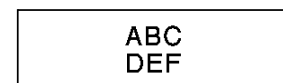

Line 2

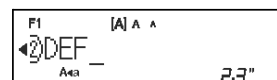

● NOTE

- The return symbol (↵) is displayed when you press the Enter key, indicating you have chosen to input a second line of text.

► Entering Accented Characters

Press [A a é] to add an accented character.



- See the table of accented characters included in this insertion sheet.
- To cancel operations, press [Esc].
- The order of accented characters differs by the selected LCD language.

Entering Text (continued)

► Changing Label Width

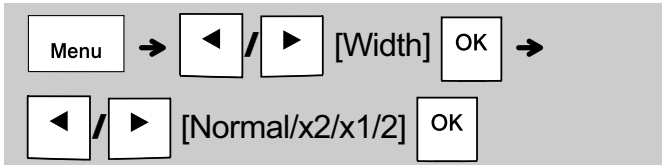

Width		Normal	
		× 2	
		× 1/2	

► Changing Label Length

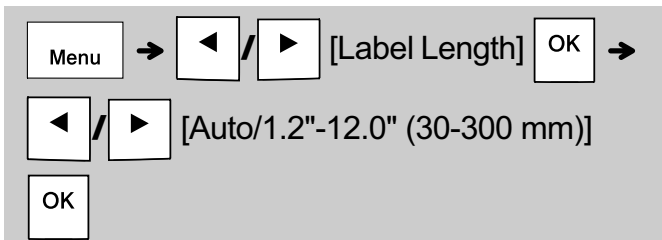

● NOTE

- After the label is printed, cut along the printed dots (:) with scissors so that the label length matches what is displayed on the LCD.
- If a specific label length has been selected, also appears in the LCD.
- By pressing the Space key, [Auto] is displayed.
- To change setting back to default, press the Space key.
- After pressing , "Accepted" is displayed for approximately one second.

► To Clear

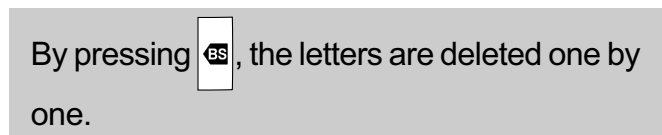

● NOTE

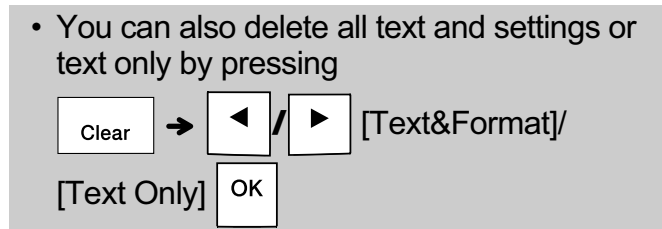

- After pressing , "Accepted" is displayed for approximately one second.

Printing Labels

► Preview

You can preview the text before printing.



- Pressing the Preview key displays a generated image of the label, and may differ from the actual label when printed.
- When the LCD cannot display all the text at once, press / to display the hidden text.
- Press / / to leave the preview mode.

► Feeding (Tape Feed)



- This function feeds approximately 1" (25mm) of blank tape.

► Printing

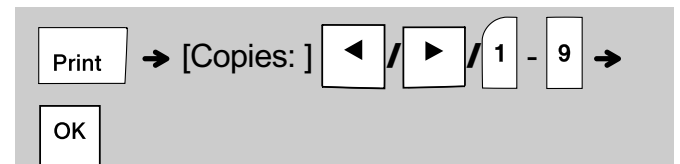

- If you need only one copy of the label, press without selecting the number of copies.
- You can print up to 9 copies of each label.
- The number of copies can also be specified by pressing a number key.
- To cut the label, push in the tape cutter lever on the upper-right corner of the label maker after the message "Please Cut" is displayed. "Please Cut" is displayed on the screen for two seconds.
- To prevent damage to the tape, do not touch the cutter lever while the message "Please Wait" is displayed.
- To remove the backing, fold the label lengthwise with the text facing inward, to expose the inside edges of the backing. Peel off the backing one piece at a time and apply.

2 BASIC USAGE (Continued)



Printing Labels (continued)







► Using Print Options



[Numbering]

You can print a series of up to nine labels at a time using auto-numbering. Using this feature you can automatically increase a selected number by one after each label is printed. The numbers of labels you can print at one time are dependent upon the initial number.

Example: To print copies of a label containing a serial number (0123, 0124 and 0125)

Enter numbers →  /  Move the cursor to the number you wish to increment



 →  →  /  [Print Option]  → [Numbering]  →



 /  Set 3-5 



- Select the highest number you wish to be printed when setting the number.

[Mirror]

Example: Follow the instructions below after entering "J.SMITH" if you want to Mirror Print "J.SMITH".

Enter text/characters →  →  / 

[Print Option]  →  /  [Mirror]

 → [Mirror Print?] 

J.SMITH

- Use clear tape in [Mirror], so you can read the labels correctly from the opposite side when attached on glass, windows or other transparent surfaces.

► Setting Margin ()

 →  /  [Margin]  →

 /  [Full/Half/Narrow/Chain Print]







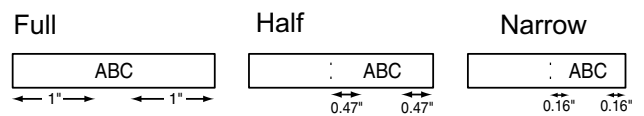

[Full]/[Half]/[Narrow]

For leaving equal margins on both sides of the text.



[Chain Print]

Use this setting when printing several labels with minimum margins.

1. Enter text.
2. Press  , then [Copies:] appears.
3. Press  /  or enter number with number keys to select the number of copies.
4. Press  . Printing starts, and then the message "Feed OK?" appears.
5. Press  to enter more text.
6. Clear the text, enter the text for the next label, and then press  .
7. When the message "Feed OK?" appears after the last label is printed, press  .
8. After the tape is fed, press the cutter lever to cut off the chain of labels.

Printing Labels (continued)

NOTE

- When you set [Chain Print], feed the tape before using the cutter otherwise a part of the text may be cut off.
- When you set [Half] or [Narrow], displayed label length is the length from the printed dots (:) to the end of the label. Cut along the printed dots (:) with scissors.

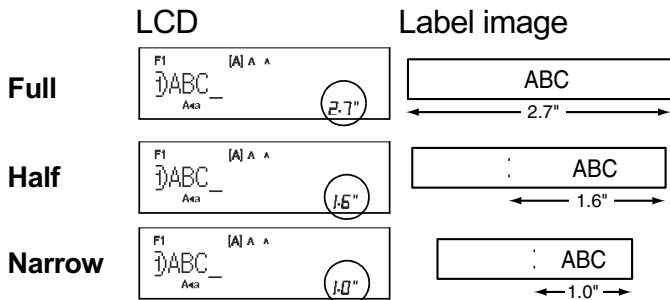

- To print more than one copy of a label with minimum margin, set the margin to [Narrow].
- Do not pull the tape since this may damage the tape cassette.
- After pressing , "Accepted" is displayed for approximately one second.

Saving Label Files

You can save up to 15 labels and recall them for printing at a later date. A maximum of 80 characters can be saved per file, a maximum of 1200 characters can be saved in total memory. You can also edit and overwrite the stored labels.

► Save

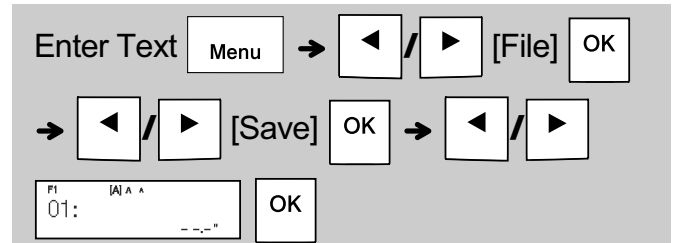

► Print

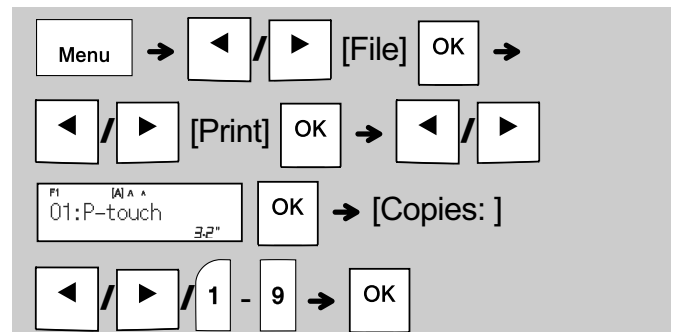

► Open

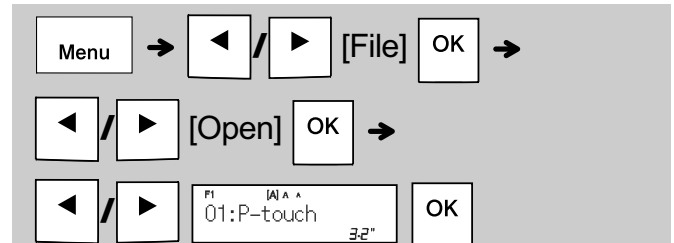

NOTE

- You can also enter the File menu by pressing → .
- If you try to store a label when there is already a label stored to that number, a message "Overwrite OK?" appears. Press to save your new label. Press to cancel.
- You must type text before starting the save function.
- After pressing , "Accepted" is displayed for approximately one second.

3 USING TEMPLATES

Cable Label

This function allows you to create two types of cable labels.

Cable Label template 1 : 

Cable Label template 2 : 

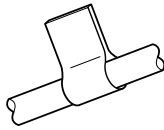



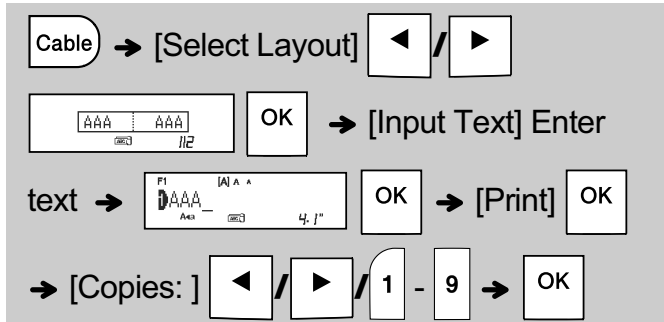

Example: Cable Label 1

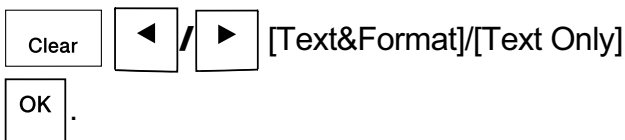

NOTE

- You cannot set label length when printing Cable Labels.
- To clear all text and settings or text only, press

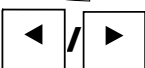

- You can set the Font, Size, Style and Frame while entering texts.
- To exit templates and return to the text input screen, do one of following:
 - Press .
 - Press  to select [Exit], and then press  when "Print" appears.
- To preview labels, press the Preview key when [Print] is displayed on the LCD.
- You cannot save labels created using templates to memory.

Text Label

This function allows you to create various labels using the built-in templates. See the Text Label templates table included in this insertion sheet.





► Example:

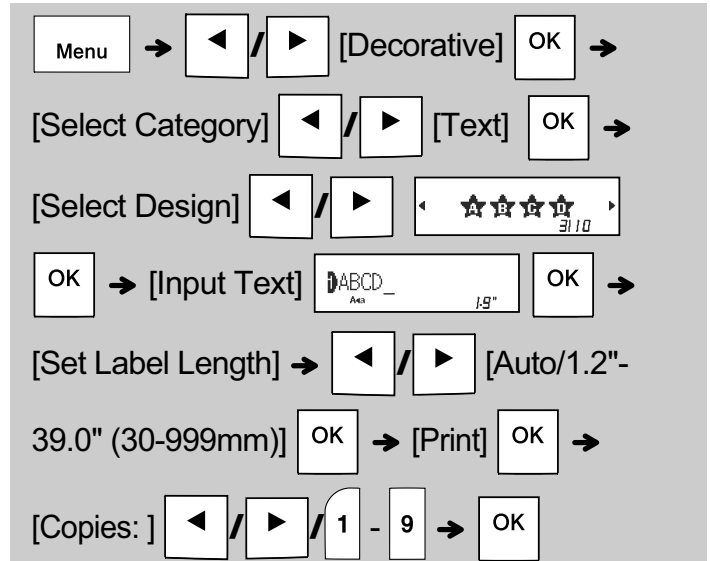



[Template that includes one repeated graphic]



NOTE

- Press the Space key to return to the initial setting for "Label Length" mode. The initial setting is [Auto].
- To clear the text, move the cursor to the right side where you wish to clear, and then press .
- To clear all text, press , then "All Clear" appears. Press  to clear. Press  to cancel.
- You cannot set the Font, Size, Style and Frame while entering texts.
- If you set the longer label length than the default ([Auto]), the text label is printed repeatedly within the set length. The text label may not be fully printed depending on the set length.
- The available label length setting changes depending on the number of texts you entered.
- These templates are available when using 0.47" (12mm) wide tape cassettes.
- You cannot edit the templates.

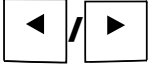
Text Label (continued)

- To exit templates and return to the text input screen, do one of following:
 - Press .
 - Press  to select [Exit], and then press  when "Print" appears.
- To preview labels, press the Preview key when [Print] is displayed on the LCD.
- You cannot save labels created using templates to memory.
- When you access Text Label or Pattern Label templates, your most recently printed Text Label or Pattern Label template label length is recalled.



Pattern Label

This function allows you to create unique labels using built-in templates. See the Pattern Label templates table included in this insertion sheet. You cannot enter text when using Pattern Label templates.

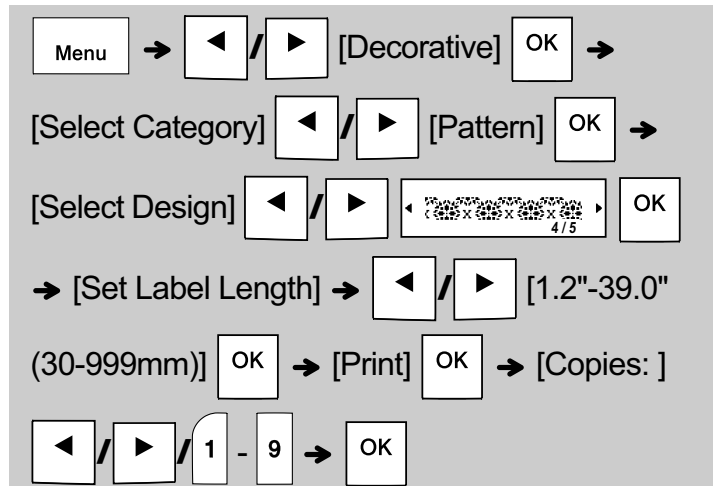
Example: 



NOTE

- Press the Space key to return to the initial setting for "Label Length" mode. The initial setting is [3.9"(100 mm)].
- These templates are available when using 0.47" (12mm) wide tape cassettes.
- You cannot edit the templates.
- To exit templates and return to the text input screen, do one of following:
 - Press .
 - Press  to select [Exit], and then press  when "Print" appears.
- To preview labels, press the Preview key when [Print] is displayed on the LCD.
- You cannot save labels created using templates to memory.
- When you access Text Label or Pattern Label templates, your most recently printed Text Label or Pattern Label template label length is recalled.

4 FORMATTING KEYS

Font Key Font

Press Font to change the font settings.

Font → ◀ / ▶ Select the settings OK

Font	A A	Helsinki	A 1
		Brussels	A 1
		Florida	A 1

Size Key Size

Press Size to change the size settings.

Size → ◀ / ▶ Select the settings OK

Size	A A A	Large	<u>A</u>
		Medium	<u>A</u>
		Small	<u>A</u>

Style Key Style

Press Style to change the style settings.

Style → ◀ / ▶ Select the settings OK

Style	A A	Normal	A
		Bold	A
		Outline	<u>A</u>
		Shadow	<u>A</u>
		Italic	<i>A</i>
		I+Bold	<i>A</i>
		I+Outline	<u><i>A</i></u>
		I+Shadow	<u><i>A</i></u>
		Vertical	∟
		V+Bold	∟

Frame Key Frame

Press Frame to select the frame design. See the Frame designs table included in this insertion sheet.

Frame → ◀ / ▶ Select a frame OK

NOTE

- To cancel operations, press Esc.
- See the Font samples table included in this insertion sheet.
- The actual printed font size depends on the tape width, number of characters, and number of input lines. When characters reach a minimum size, the selected font defaults to a custom font based on the Helsinki style. This allows you to print labels using the smallest text possible on narrow or multi-line labels.
- After pressing OK, "Accepted" is displayed for approximately one second.

Specifications

- Dimensions:** 4.3" X 8.0" X 2.2"
(W x D x H) (Approx. 109(W) X 202(D) X 55(H)mm)
- Weight:** Approx. 0.9 lb. (Approx. 400 g)
(without batteries and tape cassette)
- Power supply:** Six AAA alkaline batteries (LR03),
Six AAA Ni-MH batteries (HR03)*1
Optional AC adapter (AD-24ESA)
- Tape cassette:** Brother P-touch TZe tape widths:
0.13" (3.5mm), 0.23" (6mm),
0.35" (9mm), 0.47" (12mm)

*1 Visit <http://support.brother.com/> for the latest information about the recommended batteries.

Accessories

- Tape Cassettes:** See the included "Supplies and Accessories Guide".
- AC Adapter:** AD-24ESA
- Cutter Unit:** TC-4 (replacement)

If the cutter blade becomes blunt after repetitive use and the tape cannot be cut cleanly, turn around the cutter board as shown in the illustration ①. If you still have the difficulties, replace with new cutter unit (stock no. TC-4) by obtaining from an authorized Brother reseller.

► Replacing the Cutter Unit

1. Pull out the two sections of the cutter unit (green) in the direction of the arrows shown in the illustration ①.
2. Install a new cutter unit. Push it in until it snaps into place.

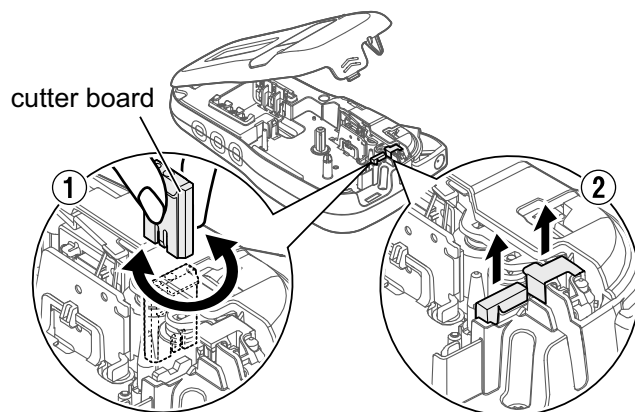

⚠ WARNING

Do not touch the cutter blade directly with your fingers.

Symbol key

► Entering Symbols

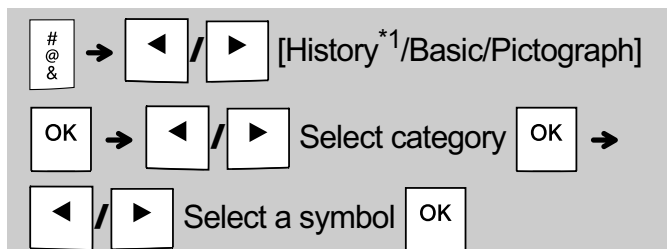

- See the table of symbols included in this insertion sheet.
- To cancel operations, press .
- *1 When you select symbols, up to seven recently used symbols are added to History.
- If you choose History, you cannot select the category.
- You can also select from basic and pictograph categories by pressing the shortcut keys included in this insertion sheet.

► Basic

Punctuation	Space key	Unit	
Mathematics		Greek Letter	
Brackets		Number	
Arrows		Shape	









► Pictograph

Fun	Space key	Kitchen	
Smiley		Garden	
Clothing		DIY	
Vehicle		School	
Sports		Office	
Animal		Signs	
Holiday		Datacom/AV	
Food/Drink		Electrical	

6 HELPFUL HINTS

Troubleshooting

► Error message

Message	Cause/Remedy
Battery Low!	The batteries are weak. If using AAA alkaline batteries: Replace them with six new AAA alkaline batteries. Do not use old and new batteries together or mix alkaline batteries with other battery types. If using Ni-MH batteries: Charge them fully.
Battery Empty!	The installed batteries are running low and need to be changed for continued operation.
Invalid!	<ul style="list-style-type: none"> • There is no text above the cursor when you selected [Numbering]. • You selected an invalid character for [Numbering]. • You selected an invalid number for [Label Length]. • You entered an invalid value as the label length while using templates.
No Text!	<ul style="list-style-type: none"> • You tried to print a text file when there is no data stored in the memory. • You pressed  when no text is entered. • You pressed  when no text is entered. • You pressed  or  when no text was entered while using templates.
2 Line Limit/ 1 Line Limit!	<ul style="list-style-type: none"> • You tried to enter a 3rd line by pressing . • You tried to print or preview two lines of text while 0.13" (3.5mm) or 0.23" (6 mm) tape is installed. Install larger tape size.
No Cassette!	You tried to print, feed or preview a label when there is no cassette installed.
Cutter Pressed	You pressed the tape cutter lever in the middle of printing process.
Text Full!	You have already entered the maximum number of characters allowed (80 characters for text, 50 characters for templates. If your message contains symbols, the maximum number of characters could be reduced.).
Text Limit! Change Length	Since the number of entered characters exceeds the label length, reduce the text, or select [Auto] as the label length.
No Frame OK?	<ul style="list-style-type: none"> • Printing on 0.13" (3.5mm) tape with invalid Frame setting ON. (Select  to print with no Frame,  to cancel.)
Feed OK?	• Feeding tape after printing when [Chain Print] is selected. See "Setting Margin".
Insert 0.47"	• Only 0.47"(12mm) tape cassette is available for templates.
Wrong Tape! Use TZe tape	• Use a tape cassette with the  mark.

► What to do when...

Problem	Solution
The display stays blank after you have turned on the label maker.	<ul style="list-style-type: none"> • Check that you installed the batteries correctly with the positive and negative ends in the correct position. • If the batteries are weak, replace them with six new AAA alkaline batteries. Do not use old and new batteries together or mix alkaline batteries with other battery types. • Check that you connected the AD-24ESA adapter correctly.
When the label is printed out, there is too much margin (space) on both sides of the text.	<ul style="list-style-type: none"> • See "Setting Margin" in this users guide and select [Half] or [Narrow] to have smaller margins for your label.
The label maker does not print, or the printed characters are not formed correctly.	<ul style="list-style-type: none"> • Check that you have inserted the tape cassette correctly. • If the tape cassette is empty, replace it. • Check that you closed the cassette cover correctly.
The label maker's settings have cleared on its own.	<ul style="list-style-type: none"> • The batteries may be weak. Replace them with six new AAA alkaline batteries. Do not use old and new batteries together or mix alkaline batteries with other battery types. • When power is disconnected for more than three minutes, all text and formats in the display are lost.
A blank horizontal line appears through the printed label.	<ul style="list-style-type: none"> • There may be some dust on the print head. Remove the tape cassette and use a dry cotton swab to gently wipe the print head with an up-and-down motion.
The label maker has "locked up" (that is, nothing happens when a key is pressed, even though the label maker is on.)	<ul style="list-style-type: none"> • See "Resetting the label maker".
The power turns off when you try to print.	<ul style="list-style-type: none"> • The batteries may be weak. Replace them with six new AAA alkaline batteries. Do not use old and new batteries together or mix alkaline batteries with other battery types. • Check that you inserted the batteries correctly. • A wrong adapter is used; the recommended adapter is the AD-24ESA.
The tape does not feed correctly or the tape gets stuck inside the label maker.	<ul style="list-style-type: none"> • Check that the end of the tape feeds under the tape guides. • The cutter lever is pressed while printing. Do not touch the cutter lever during printing.
To change language setting.	<ul style="list-style-type: none"> • See "Initial Settings".

6 HELPFUL HINTS (continued)



Short Cuts

Language	Menu → Space key
Width	Menu → 1
Label Length	Menu → 2
Margin	Menu → 3
File	Menu → 4
Decorative	Menu → 5
Print Option	Menu → 6
Feed	Menu → 7
Unit	Menu → 8
LCD contrast	Menu → 9

Resetting the label maker

You can reset the label maker when you want to restore it to factory settings, or in the event it is not working correctly. All text, settings and stored files are cleared.

1 Turn off the label maker, hold down

 and , and then press  to turn the label maker back on.

2 First release the power button, and then

release  and .

The label maker turns on with the internal memory reset.

Should you encounter any problems with your product, please do not return your product to the store. After referring to the User's guide, if you still need assistance, contact Brother Customer Service at:

Voice: 1-877-BROTHER

Web: www.brother-usa.com

Fax: 1-901-379-1210

If you need to locate a service center, please call 1-877-BROTHER or visit www.brother-usa.com

⚠ CAUTION

USING A COMBINATION OF DIFFERENT BATTERIES (SUCH AS Ni-MH AND ALKALINE), MAY RESULT IN AN EXPLOSION. DISPOSE OF USED BATTERIES ACCORDING TO THE INSTRUCTIONS.

NOTE

Battery Recommendations

- Remove the batteries if you do not intend to use the label maker for an extended period of time.
- Dispose of the batteries at an appropriate collection point, not in the general waste stream. In addition, be sure to observe all applicable federal, state, and local regulations.
- When storing or discarding the batteries, wrap it (for example with cellophane tape), to prevent it from short-circuiting. (See the picture on the lower right)

(Battery insulation example)

1. Cellophane tape
2. Alkaline or Ni-MH battery

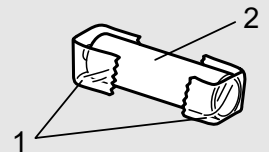

Category	Symbols (Basic)	% a
Punctuation ?!&	. , : ; " ' • ? ! ¿ i - & ~ _ \ / * @ #	
Mathematics +x±	+ - × ÷ ± = ≥ ≤ ≠	
Brackets ()[]	() [] < > « » 【 】	
Arrows →↑	→ ← ↑ ↓ ↔ ⇌ ↕	
Unit %\$	% \$ ¢ € £ ¥ ¤ ° ft.in.m²m³cc ℓ oz.lb.°F°C	
Greek Letter αβ	α β γ δ μ Ω φ Σ ª º	
Number ²³IV	₂ ₃ ² ³ ¼ ⅓ ½ ⅔ ¾ I II III IV V VI VII VIII IX X	
Shape ●☆	● ○ ■ □ ★ ☆ ♠ ♣ ♥ ♦ ♣ ▲ △ ▼ ▽	

Category	Symbols (Pictograph)	🎨📦
Fun		
Smiley		
Clothing		
Vehicle		
Sports		
Animal		
Holiday		
Food/Drink		
Kitchen		
Garden		
DIY		
School		
Office		
Signs		
Datacom/AV		
Electrical		

Accented Characters

A	Á Â Ã Ä Å Æ Æ Ā Ā Ā Ā	a	á à â ä æ ā ą å ā ā
C	Ç Ć Ć	D	Ď Ď
c	ç ć ć	d	d' ð đ
E	É È Ê Ë Ę Ę Ę Ę	e	é è ê ë ę ę ę ę
G	Ĝ Ĝ	I	Í Î Ï Ĳ Ĳ Ĳ
g	ĝ ĝ	i	í î ï ĳ ĳ ĳ
K	Ķ	L	Ł Ł Ł Ł
k	ķ	l	ł ł ł ł
N	Ñ Ñ Ñ Ñ	R	Ŕ Ŕ Ŕ Ŕ
n	ñ ñ ñ ñ	r	ŕ ŕ ŕ ŕ
O	Ó Ò Ô Ø Ö Ö Œ Œ	o	ó ò ô ø ö ö œ œ
S	Š Š Š Š Š Š	τ	Ŧ Ŧ Ŧ Ŧ
s	š š š š š š	t	ŧ ŧ ŧ ŧ
U	Ú Û Ü Ü Ů Ů Ů Ů	u	ú û ü ü ů ů ů ů
Y	Ý Ÿ	z	Ž Ž Ž Ž
y	ý ÿ	z	ž ž ž ž

Font samples

Helsinki	ABC\$&€39	Florida	ABC\$&€39
Brussels	ABC\$&€39		

Text Label templates

01		05		08	
02		06		09	
03		07		10	
04					

Pattern Label templates

01		03		05	
02		04			

Frame designs

01	Off (No frame)	05		09		13	
02	<u>ABCDE</u>	06		10		14	
03	<u>ABCDE</u>	07		11		15	
04		08		12		16	

* Images are only for illustrative purposes.