



# User Manual

**ME-6000-WPTV**  
**ME-10000-WPTV**



**Service and support:**

Call your local Service representative

**This manual contains important instructions that you should follow during installation and maintenance of the UPS and batteries. Please read all instructions before operating the equipment and save this manual for future reference.**

## Safety Instructions

**Please read carefully the following user manual and the safety instructions before installing or operating the unit!**

### Operation Safety

Please read all instructions before operating the equipment and connecting to mains power, save this manual for future reference.

Please pay attention to all the warning indication, understand and follow all the instruction.

Do not install the UPS where it would be exposed to direct sunlight , Rain or damp environment.

Do not install the UPS near to heating equipment or heating source and heating environment.

Do not block ventilation openings on the UPS's housing. Ensure the air vents on the front, side and rear of the UPS are not blocked. Recommended at least 50cm of space on each side.

Use dry cloth for cleaning.

Use dry-chemical fire extinguisher when UPS present fire danger, do not use fluid-fire extinguisher, fluid- fire extinguisher will cause hazards shock.

### Electricity Safety

Do not remove the enclosure. This system is to be serviced by qualified service person only. There are NO USER SERVICEABLE PARTS inside the UPS.

- Assure UPS is reliably connected to earth properly verify connecting wire and battery polarity is correct before turn on UPS with mains power.
- If UPS requests moving to another place or reconnecting power wire, it is imperative to disconnect all the power connections of UPS, and turn off UPS.
- Please used the UPS accessories.
- Shock Risk.

If equipment powered by UPS require any type of maintenance, it is imperative to disconnect it from UPS before maintenance.

If input or output terminal need any maintenance or installation, it is imperative to disconnect all the power connections of UPS and turn UPS off.

## **Battery Safety**

- The service lifetime of UPS battery depends on ambient temperature, high ambient temperature will impact the service lifetime of UPS battery. Replace battery on regularly can help to keep UPS running efficiently and provide backup time as expected.
- Batteries must be maintained and replaced only by qualified person.
- Batteries have a high short-circuited current and pose a risk of shock. Take all precautionary measures specified below and any other measures necessary when working with batteries:
  - a. Remove all jewellery, wristwatches, rings and other metal objects.
  - b. Use only tools with insulated grips and handles.
  - c. Wear rubber gloves and boots.
  - d. Do not lay tools or metal parts on top of batteries.
  - e. Disconnect the charging source prior to connecting or disconnecting battery terminals.
- Do not attempt to dispose of batteries by burning them. It could cause explosion.
- Do not open or destroy batteries. Effluent electrolyte can cause injury to the skin and eyes. It may be toxic. If cause injury by Effluent electrolyte, use cool water for washing and go to hospital ask for help immediately.
- Do not short the battery with metal objects, It could cause an electric shock, fire or explosion.

## **Maintenance**

- The operation environment and store environment will impact on the service lifetime and reliability of UPS.

Do not install or store the UPS in the places where are listed below.

- a. Do not install UPS in place where the ambient temperature lower than 0°C or higher than 40°C .
- b. Do not install/store UPS in place where the relative humidity lower than 20% or higher than 90%.

- c. Do not install/store UPS in place where there is flammable or corrosive gas, place with large amounts of conductive dust, place exposed to shock or vibration, or outdoor.
- If you would store the UPS for a long period, the storing area temperature should be the range of  $-25^{\circ}\text{C}$  to  $55^{\circ}\text{C}$ , and before turning on UPS, it is highly suggested to put UPS in the ambient temperature above  $0^{\circ}\text{C}$  and last at least 2 hours.

## CONTENT

1.Introduction .....	1
1.1 Symbol and Explanation.....	2
1.2 Front view .....	2
1.3 Rear View .....	3
1.4 product specification .....	4
2.Installation.....	6
2.1 Inspection the pack and equipment. ....	6
2.2 Power cable .....	6
2.3 UPS Power Connection .....	7
2.4 UPS Connect To Computer Port .....	11
2.5 UPS Parallel Card (Optional).....	11
2.6 EPO .....	14
2.7 Maintenance switch(Optional) .....	14
2.8 Connectivity Cards .....	16
2.9 Software.....	17
3.Control & Display Panel .....	18
3.1 LCD panel .....	18
3.2 LCD description .....	19
4.Operation .....	22
4.1 Turn on UPS .....	22
4.2 Turn off UPS .....	25
5.Maintenance .....	26
6.Trouble shooting.....	27

# 1. Introduction

The On-Line-Series is an uninterruptible power supply incorporating double-converter technology. It provides perfect protection specifically for Computer equipment, communication systems and industry control systems.

The double-converter principle eliminates all mains power disturbances. A rectifier converts the alternating current from the socket outlet to direct current. This direct current charges the batteries and powers the inverter. On the basis of this DC voltage, the inverter generates a pure sinusoidal AC voltage, which permanently supplies the loads.

Computers and periphery are thus powered entirely by the mains voltage. In the event of power failure, the maintenance-free batteries power the inverter. In the event of inverter failure/Overload, UPS transfer to bypass mode, after the failure/overload remove, UPS transfer to inverter mode continue supplies the loads.











This manual covers the UPS listed as follows. Please confirm whether it is the model you intend to purchase by performing a visual inspection of the Model No. on the rear panel of the UPS.

ME-6000-WPTV: Single phase input single phase output, Standard with battery.

ME-10000-WPTV: Single phase input single phase output, Standard with battery.

## 1.1 Symbol and Explanation

Some or all of the following symbols may be used in this manual. It is advisable to familiarize yourself with them and understand their meaning:

Symbol and Explanation			
Symbol	Explanation	Symbol	Explanation
	Alert you to pay special attention		Alternating current source(AC)
	Caution of high voltage		Direct current source(DC)
	Turn on the UPS		Protective ground
	Turn off the UPS		Recycle
	Idle or shut down the UPS		Do not dispose with ordinary trash

## 1.2 Front view

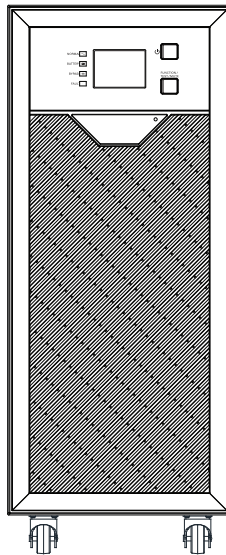



## 1.3 Rear View

1. RS232
2. Fan
3. AC Input Breaker
4. Terminal Cover
5. Beam Frame
6. Maintenance Bypass Switch (Optional)
7. Intelligent Slot(SNMP card included)
8. EPO
9. Parallel Card(Optional)

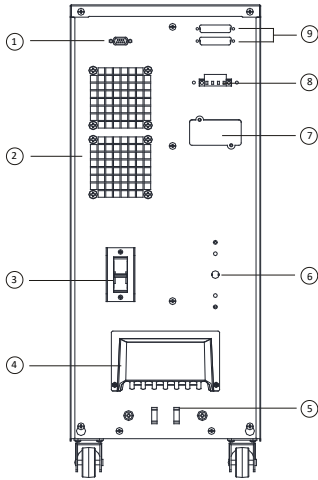

6K

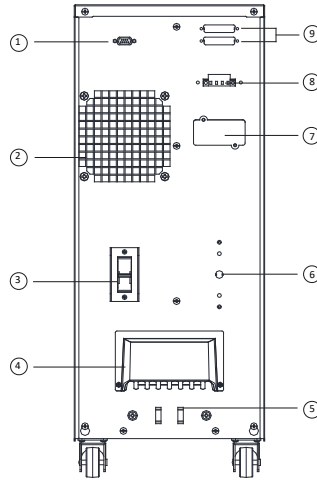

10K

## 1.4 product specification

Model	ME-6000-WPTV	ME-10000-WPTV
Dimensions W*D*H(mm)	248 x 500 x616	248 x500 x616
Weight(kg)	58.9	62.1
Power		
Apparent Power (KVA) / Active power (KW)	6KVA/ 5.4KW	10KVA/ 9KW
Mains		
Voltage range	120Vac-275Vac(phase to phase)	
Current*	32.1A max	52.6 A max
Frequency range	40Hz-70Hz	
Power factor	0.99	
Output		
Rating Voltage	230Vac(±1%)	
Rating Current	27A	45A
Frequency range	50Hz x (1±1%); Follow main power in phase lock range	
Power factor	0.9	
Output Overload	105%-125%, load transfer to bypass mode after 10 min (0-30℃ ) or 1min(30-40℃ ); 125%-150%,load transfer to bypass mode after 30s; Over 150%, load transfer to bypass after 0.5s	
Load crest ratio	3:1( max)	
THD	<2%( 100% Line load)	
Environmental and safety		
EMC Standard	EN IEC 62040-2:2018/ EN 62040-2:2006/ IEC 62040-2:2016	
Safety Standard	EN62040-1:2008+A1:2013	
Operation temperature	0-40℃	
Store temperature	-25℃ to 55℃	
Relative humidity	20% to 90%	
Altitude	<1000m	

\*The max current is under 176Vac input, full rating load and empty battery charging.

⚠ Waring: this is a product for commercial and industrial application in the second environment installation restrictions or additional measures may be needed to prevent disturbances.

⚠ NOTE: It is recommended that the UPS output line is not more than 10m, the external communication line, and the machine line and the temperature detection line is not more than 3m, otherwise it may need to take installation restrictions or additional measures to suppress interference.

Altitude load=Rating load\*Altitude correction factor.

Altitude(m)	1000	1500	2000	2500	3000	3500	4000	4500	5000
Altitude correction factor	100%	95%	91%	86%	82%	78%	74%	70%	67%

⚠ Note: if UPS used over 1000m altitude, the rating must be derating according to above table.

## 2. Installation

 **Danger:** For safety consideration, please make sure cut off all the mains power.

 **Note:**

1. Installation and power cable connection must be conducted by qualified person according to local regulations.
2. We recommend UPSs installed as floor standing equipment.
3. After installation, ensure the air vents on the front, side and rear of the UPS are not blocked. Recommended at least 50cm of space on each side.
4. If it is necessary to connect the inductance load such as a monitor or a laser printer to the UPS, the start-up power should be used for calculating the capacity of the UPS, as its start-up power consumption is too big when it is started.

### 2.1 Inspection the pack and equipment.

1. Open UPS pack, inspection whether UPSs have been damaged during shipment.
2. If find any equipment damaged, please contact your representative.

Accessory: 1 pcs of user manual.



**Recycle**

The UPS package is recycling, please save it for further use.

### 2.2 Power cable

 **Note:**

The diameter and cross-sectional area depends of power cable depend on the UPS rating power, the minim diameter and cross-sectional area of power cable see below power cable table.

Model		ME-6000-WPTV	ME-10000-WPTV
Input	G	6mm2	10mm2
	N	6mm2	10mm2
	L	6mm2	10mm2
Battery	+	6mm2	10mm2
	-	6mm2	10mm2
	G	6mm2	10mm2
Output	L	6mm2	10mm2
	N	6mm2	10mm2
	G	6mm2	10mm2

## 2.3 UPS Power Connection

**⚠ DANGER:** In order to avoid the Mains power switch current overload when UPS carries with rating load, the Mains power switch rating current must be more than the bypass switch rating current. (bypass mode max current refer to 1.4 product specification)

It is suggested to install an external isolating device against current backfeed between Mains input and UPS (see Fig.). After the device is installed, it must add a warning label with the following wording or the equivalent on the external AC contactor : RISK OF VOLTAGE BACKFEED. Isolate the UPS before operating on this circuit, then check for hazardous voltage between all terminals.

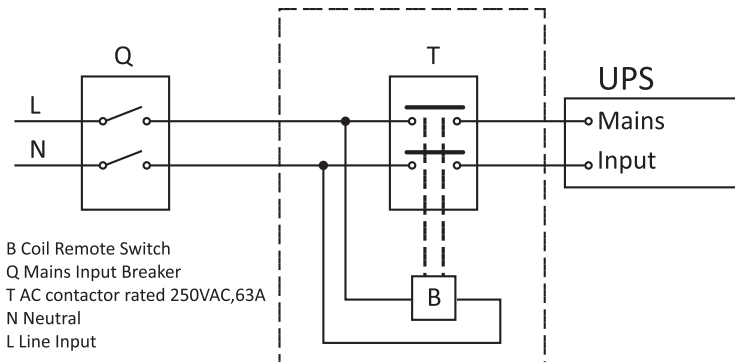

1. Select power cable referring to power cable table.
2. Open UPS terminal cover.

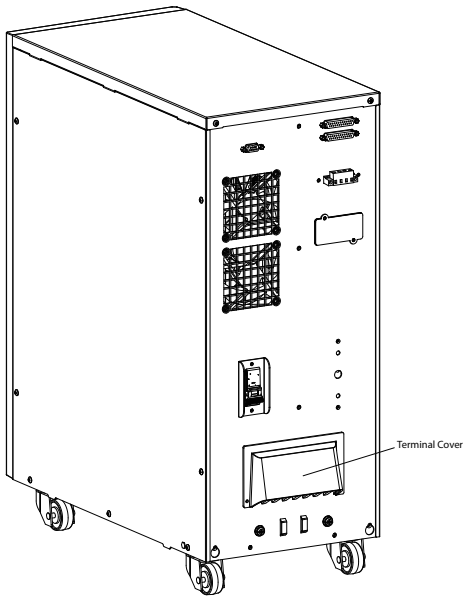

3. Connect the protective earthing conductors to the rear panel left earthing terminal.
4. Connect the protective bonding conductors to the rear panel right earthing terminal.
5. Connect the output cable to the output terminal.
6. Connect the input cable to the input terminal.

**⚠ DANGER:** In order to reduce the risk of fire and hazards shock, make sure all the connections are reliable and stightly!

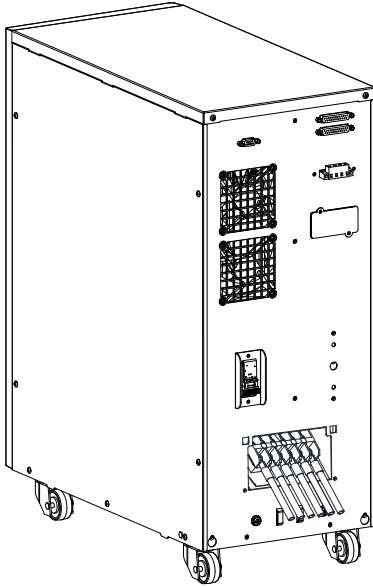

Input		Output	
N	L	L	N

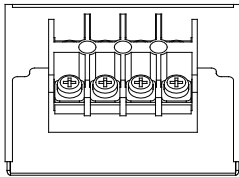

Input Ground



Output Ground



7. Make the straps through across the Beam frame.
8. Adjust the straps to proper position; Fix the input cable, output cable tightly.
9. Re-screw the terminal cover.

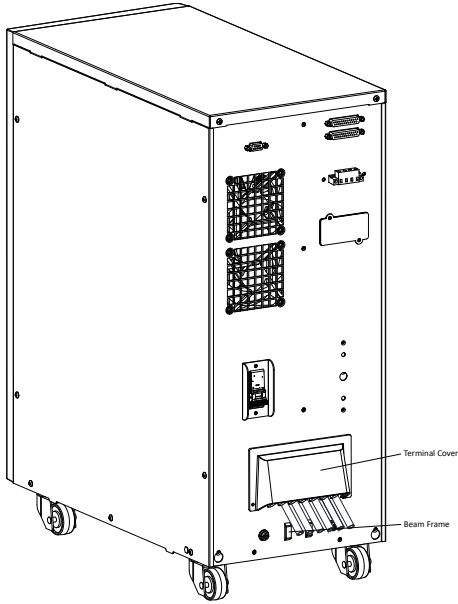

10. Connect the main power, set input protect breaker to "ON" to power UPS.

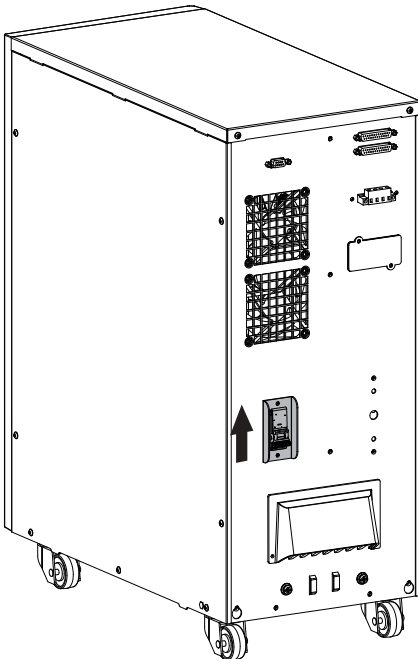

## 2.4 UPS Connect To Computer Port



RS232 interface is for the monitoring software and firmware update. UPS connect to monitor device with RS232 cable.

1. One end of RS232 cable connects to computer RS232 port.
2. One end of RS232 cable connects to UPS RS232 port.

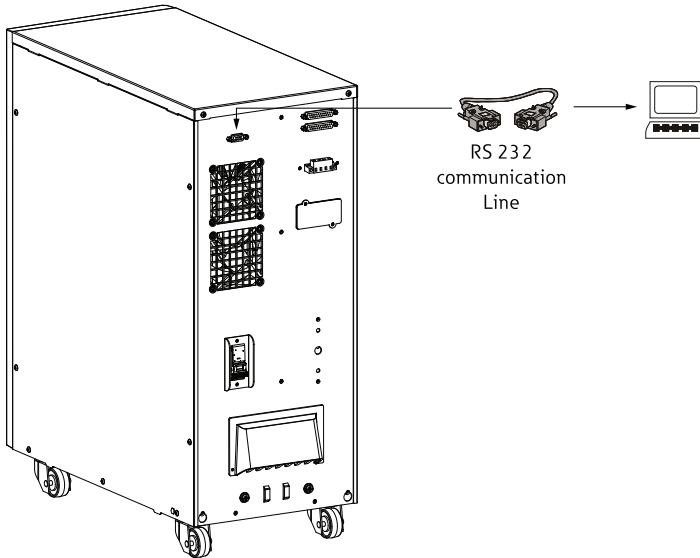

## 2.5 UPS Parallel Card (Optional)

- **Brief introduction of the redundancy**

N+X is currently the most reliable power supply structure. N represents the minimum UPS number that the total load needs, X represents the redundant UPS number, i.e. the fault UPS number that the system can handle simultaneously.

When the X is larger, the reliability of the power system is higher. For occasions where reliability is highly depended on, N+X is the optimal mode. As long as the UPS is equipped with parallel cables, up to 3 UPSs can be connected in parallel to realize output power sharing and power redundancy.

- **Parallel installation and operation**

Parallel UPS is an optional function for user, before installing a new parallel UPS, user need to prepare parallel accessories and ask service person to help for installation. The quantity of parallel UPS is up to 3 max. Each parallel UPS

need an independent battery pack.

1. Connect each UPS one by one with the parallel cable, the parallel card is the communication port between UPSs.

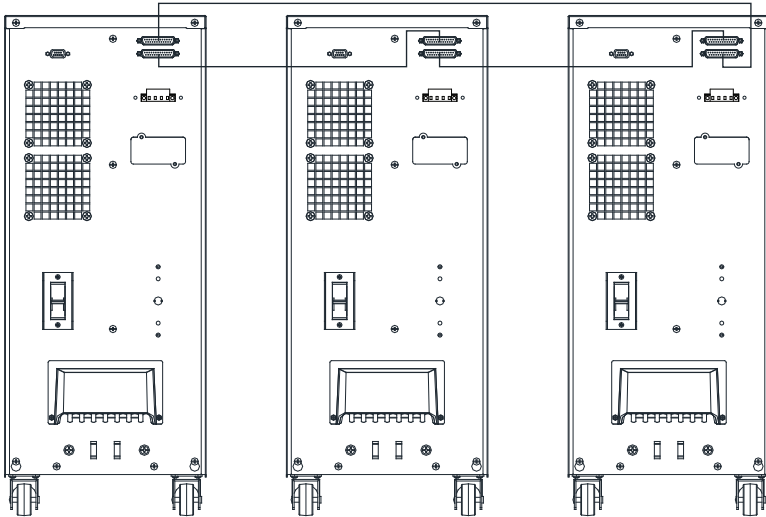

2. Connect the output wire of the parallel UPSs to an output terminal block, load connect to the output terminal block via load wire.

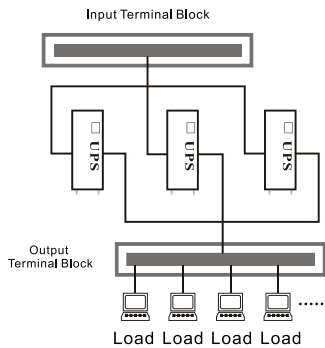

⚠ Note:

Output wire requirement:

The distance between the UPSs in parallel is less than 20 meters. The difference between the wires of input and output of the UPSs is required to be less than 20%. The distance between the UPSs in parallel is more than 20 meters. The difference between the wires of input and output of the UPSs is required to be less than 10%.

3. The parallel UPS input terminal panel and output terminal panel see below, the wires of each parallel UPS must follow the wire requirement for single UPS.
4. Each parallel UPS need an independent battery pack.

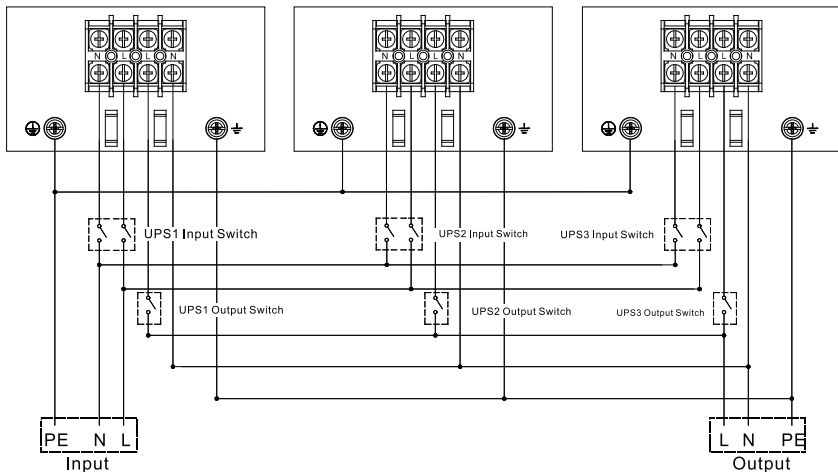

- **Parallel UPS Advantage**

This method increase UPS reliability with redundancy structure, 2 paralleled UPS share the load. When one UPS failure, the other support the load. That the  $\frac{1}{2}$  redundancy.

- **Operation Introduction**

1. Normal operation need to follow operation guide for single UPS.
2. Turn on parallel UPS:

Turn on UPS with power normal: After main power connection done, long press  $\cup$  button for one UPS and all the paralleled UPS will go to Online mode.

Turn on UPS without main power: Short press each UPS  $\cup$  button to make each UPS power on, then long press one UPS  $\cup$  button and all the paralleled UPS will go to Battery mode.

**⚠ Note:**

Long press means press for more than 1 second;

Short press means press for less than 1 second;

## 2.6 EPO

EPO(Emergent Power Off), it is a green connector lays on the UPS rear panel, we can shutdown UPS via remove EPO connector in the event of emergency. The EPO wire connect diagram see below.

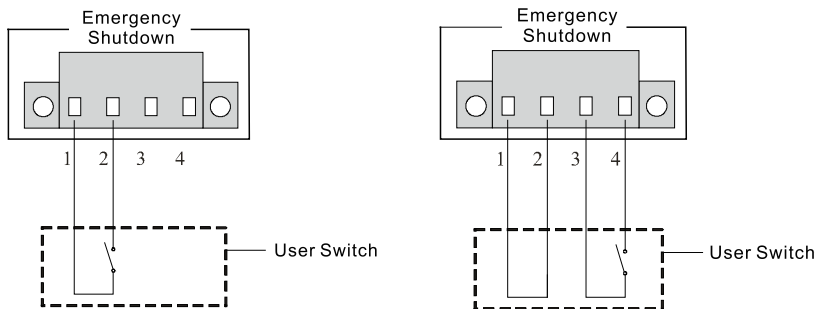

Pin 1 closed to pin 2, UPS shutdown immediately.  
Pin 3 and pin 4 float.

Pin 1 and Pin2 always connect.  
When pin3 and pin4 disconnect, UPS shutdown immediately.

## 2.7 Maintenance switch(Optional)

No matter UPS work in line mode, battery mode or bypass mode, UPS internal electrical part is present hazards high voltage. Maintenance switch can help service person to maintain UPS in online mode, make sure UPS continue to provide power to your equipment in bypass mode and the safety of service person during maintenance. The procedure list as below:

- 1) Verify the bypass function can work normally.

- 2) Transfer UPS in to bypass mode.
- 3) Switch maintenance switch to maintenance position.
- 4) Switch off UPS bypass mode switch, line mode input switch and battery input switch.

After verify no hazards, service person can begin to maintain UPS without interrupting power supply to your equipment.

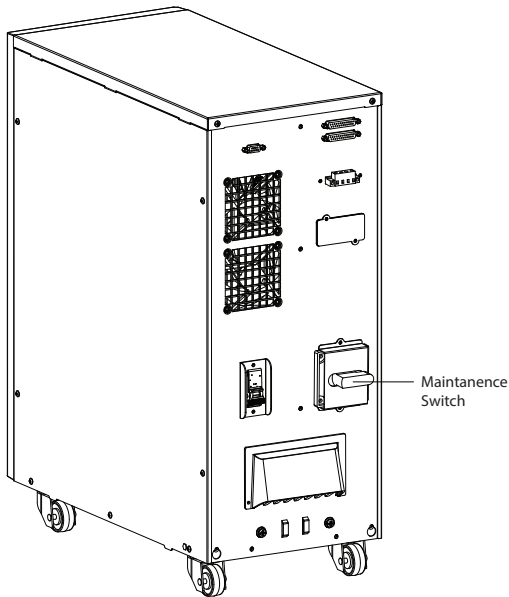
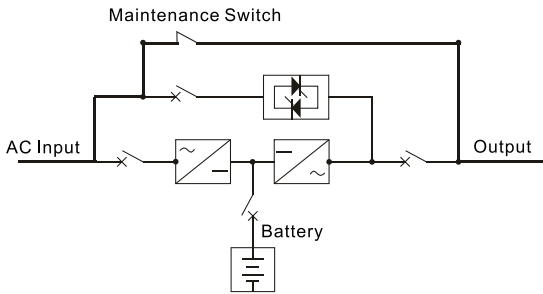

## 2.8 Connectivity Cards

Connectivity cards is an optional accessory for UPS, Connectivity cards allow the UPS communicate in a variety networking environment and with different types of devices. User can select AS400 card, NMC card, CMC card, USB port +RS232, the service person will provide installation. Before installation, UPS must be turned off.

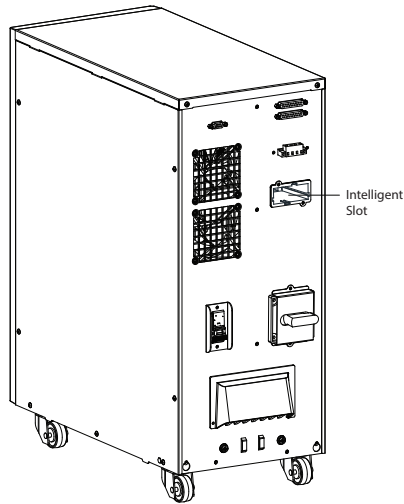

AS400 card: It owns isolated dry contact relay outputs for UPS status: such as Mains/Utility failure, Battery low, UPS alarm/OK, or on Bypass and so on. More detail about the interface definitions please read the AS400 user manual.

NMC card: NMC (Network Management Card) allows the UPS to communicate in a variety of networking environments and with different types of devices. NMC achieves a remote management for the UPS through internet/intranet. Please contact your local dealer for further information. More detail please read the NMC user manual .

CMC card: It provides connection to Modbus protocol with standard RS485 signal. More detail please check the CMC user manual.

USB+RS232 card: To establish communication between the UPS and a computer by use an appropriate communication cable to monitor UPS.

**⚠ Note:**

Further information please refer the card user manual.If require WinPower sofare and AS400, NMC, CMC, USB+RS232.Any detail and further information, please contact your representative.

## 2.9 Software

### Free Software Download – WinPower

WinPower is brand new UPS monitoring software, which provides user-friendly interface to monitor and control your UPS. This unique software provides safely auto shutdown for multi-computer systems while power failure. With this software, users can monitor and control any UPS on the same LAN no matter how far from the UPSs.

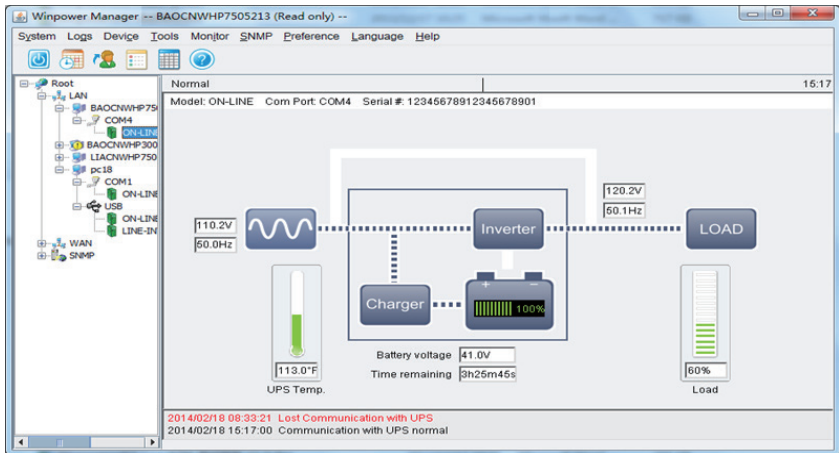

### Installation procedure:

1. Go to the website:  
<http://www.ups-software-download.com/content/ups-download-software/download.html>
2. Choose the operation system you need and follow the instruction described on the website to download the software.

When your computer restarts, the WinPower software will appear as a green plug icon located in the system tray, near the clock.

### 3. Control & Display Panel

#### 3.1 LCD panel

Control & Display panel is in the front of UPS, the panel includes 2 buttons, 4 LED indicators and 1 LCD screen.

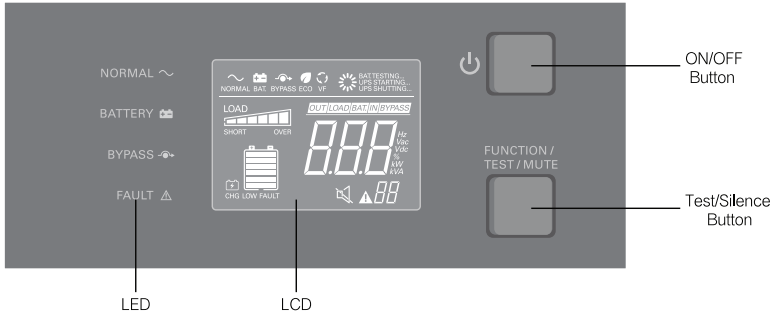

The following table shows the buttons and description:

The button	Function	Illustration
On/Off button	Turn on/off UPS	
Function button	Mute	Press the button continuously for 2 to 10 seconds when buzzer beep for bypass-mode or battery-mode, buzzer will be muted; Press the button continuously more than 10 seconds when buzzer beep for alarm, buzzer will be muted; repetition Repeated operation will cancel previous operation
	Battery self-test	Press the button continuously for 2 to 10 seconds when UPS in Online mode
		Quick press the button to switch display meters.

The following table shows the indicator status and description:

Indicator	Behavior	Description
Normal	Light	UPS operates normally, power module supply power for load.
	Off	Load powered by bypass (Not ECO-mode), or UPS no output.
Battery	Light	Battery supply power for load, Normal LED also lighted.
	Blink per second	Charger or battery being abnormally.
Bypass	Light	UPS works in ECO-mode (Normal LED also lighted), or load powered by bypass.
	Blink per second	Bypass being abnormally.
Fault	Light	UPS in fault-mode, UPS will keep powering for load when no EPO signal or short-circuit fault.



### 3.2 LCD description

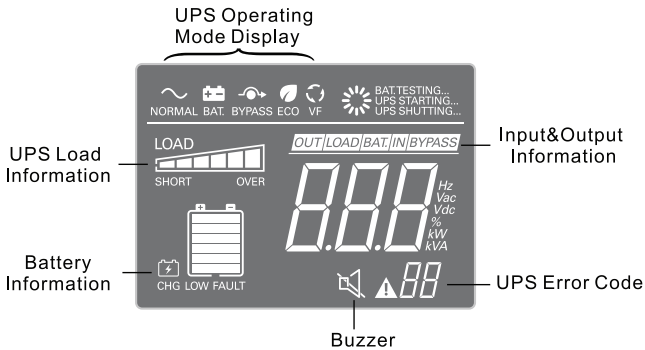

- **Load information.**

1. Load display as percentages. Following table shows the load display specification.

Grid Quantity (from left to right)	Actual Load
Level 1	0% - 15%
Level 2	16% - 35%
Level 3	36% - 55%
Level 4	56% - 75%
Level 5	76% - 95%
Level 6	≥96%

2. SHORT icon will be displayed as bellow when UPS output is short-circuited:

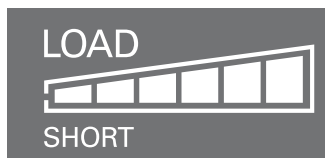

3. OVER icon will be displayed in load information board when UPS works in over-load state:



- **UPS meters**

The following information will be display in LCD panel: Input voltage, input frequency, output voltage, output frequency, battery voltage, and load meters. Quick press the button to switch display categories, items within the same category will be switched automatically.

Type	Items		
Output	Voltage	Frequency	
Load	Active power(W)	Apparent power(VA)	Level(%)
Battery	Voltage	Capacity	Quantity
Input	Frequency	Three phase voltage( phase –phase)	--
Bypass	Voltage	Frequency	--

- **Battery information: display battery capacity level in present(%).**

Grid Quantity (from bottom to top)	Capacity level
1	0%-15%
2	16%-35%
3	36%-55%
4	56%-75%
5	76%-95%
6	≥96%

1. When battery voltage is low, LOW icon will display as below:





2. When battery fault, FAULT icon will display as below:



3. If charger is normal working, CHARGING icon will light up.



- **Buzzer:**

when buzzer beeps and  icon display, it indicates UPS abnormal or fault alarm. Press  can end buzzer beeping(silence mode).





- **Fault/Alarm display:**

UPS abnormal, fault or alarm indication information need to deal with, below icon light up.

 Lightened circularly: alarm information.

 Lightened constantly: critical fault.

- **UPS working mode display:**

Icon	Information description
	UPS is working in normal mode.
	UPS is charging battery.
	UPS is working in bypass mode.
	UPS is working in ECO mode.

## 4. Operation

### 4.1 Turn on UPS

**⚠ Note:**

Battery is fully charged after manufacture, but energy may be loss after transportation and storage. Suggest charge the battery for 12 hours or more before using, to ensure enough backup time.

- **Prepare to turn on**

1. Connect main power and close battery switch, then turn bypass protect switch to “ON” side. If the battery cell numbers displayed in the LCD is different from actual, please call your representative.

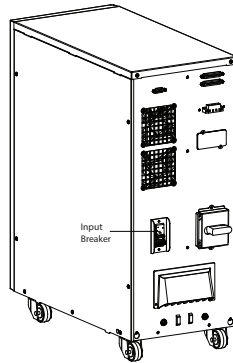

2. Turn input protect switch to “ON” side, check the information displayed in the LCD. If any alarm or fault information display in marked area, please call your representative.

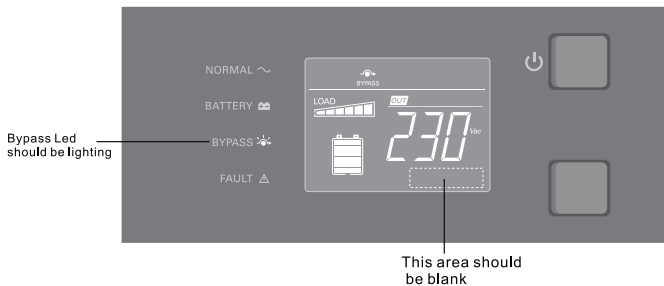

**⚠ Note: Please turn off all the switch before maintenance.**

UPS turn on operation: turn on by main power and turn on by DC (without main power).

- **Turning On UPS With Mains**

1. Press On/Off button continuously longer than 1 second, UPS will turn on. System self-test will be carried out when UPS turn on.

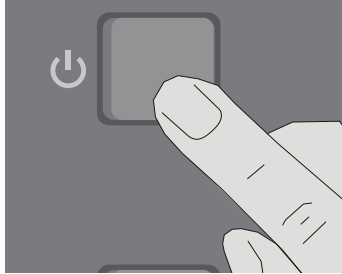

2. UPS turn to Online mode after self-test. Indicator and LCD display as following: Normal LED lighted, no fault displayed.

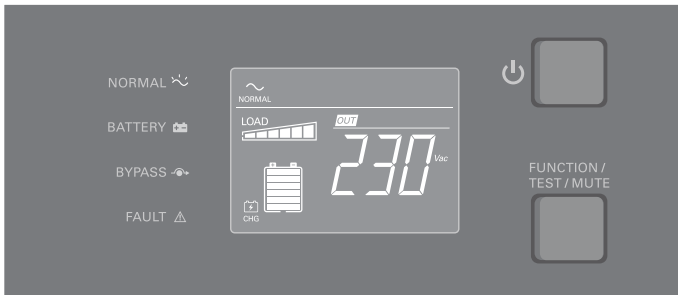

(Online mode)

Indicator description:

Indicator light:  indicator off: 

**⚠ Note: UPS will turn to battery mode when main power abnormal.**

3. UPS supply power for load, “charging” icon indicated that inner charger is charging the battery.

- **Turning On Without Mains (cold start)**

1. Press On/Off button continuously longer than 1 second, UPS will turn on. System self-test will be carried out when UPS turn on.

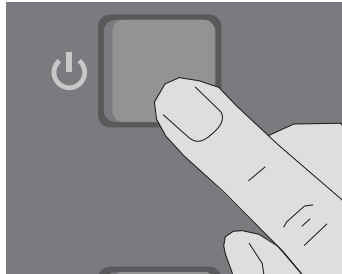

2. UPS turn to battery-mode after self-test. Both Normal LED and battery LED lighted. Load powered by battery.

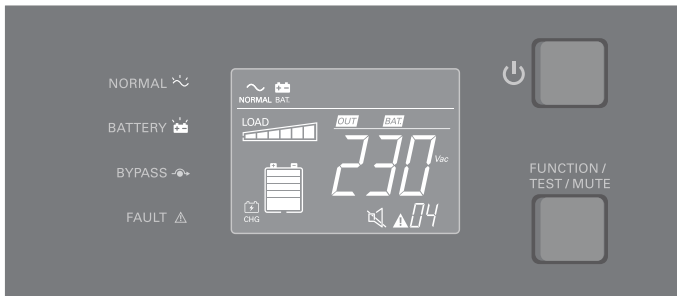

3. Buzzer beep once every 4 seconds to indicate user than UPS is working on battery-mode. Buzzer can be muted when function button pressed more than 2 seconds.
4. 04 and 08 warning code will alternate displayed on the bottom right corner of LCD, because of lack of main power.

## 4.2 Turn off UPS

1. Press On/Off button continuously longer than 1 second, UPS will be turned off.

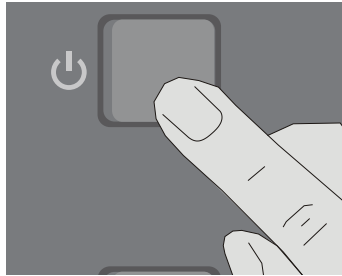

2. UPS supply power by bypass after turn off. Indicator and LCD display as following: Normal LED lighted, no fault displayed:

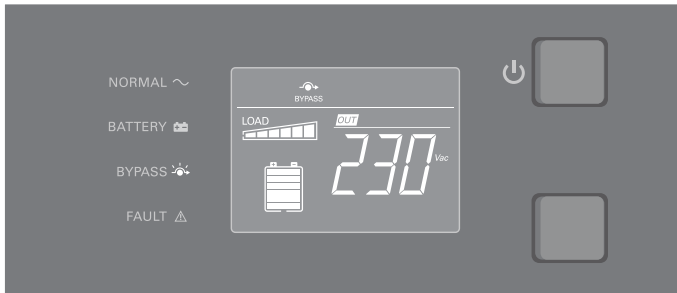

3. Bypass LED light and buzzer beep once every 2 seconds to indicate that UPS work on bypass-mode. Buzzer can be mute when function button pressed longer than 2 seconds.
4. UPS without output when main power input switch, bypass protect switch and battery switch is open.

## 5. Maintenance

This series UPS only requires minimal maintenance. The battery used for standard models are value regulated sealed lead-acid maintenance free battery. These models require minimal repairs. The only requirement is to charge the UPS regularly in order to maximize the expected life of the battery. When being connected to the mains power, whether the UPS is turned on or not, the UPS keeps charging the batteries and also offers the protective function of overcharging and over-discharging.

The UPS should be charged once every 4 to 6 months if it has not been used for a long time.

If the battery is found not in good condition, replacement should be made. Battery replacement should be performed by qualified person.

Replace batteries with the same quantity and same type of batteries.

Do not replace the battery individually. All the batteries should be replaced at the same time following the instructions of the battery supplier.

Normally, the batteries should be charged and discharged once every 4 to 6 months. Charging should begin after the UPS shuts down automatically in the course of discharging, the standard charging time for the standard UPS should be at least 12 hours.



In the regions of hot climates, the battery should be charged and discharged every 2 months. The standard charging time should be at least 12 hours.



If UPS is intend to be used in a no-people environment for a long time, need to inspect whether battery is normal in circularly to avoid battery damage caused by over-discharge.



## 6. Trouble shooting

If the UPS system does not operate correctly, check the operating status on the LCD display. And please attempt to solve the problem using the table below.

Event Name	Warning Icon 	Fault Code 	Possible cause	Remedy
UPS fail to start	--	--	Press ON/OFF button Less 0.5s.	Press ON/OFF button more than 1s.
		0A/0b	UPS do not connect to battery or battery low voltage.	Connect UPS to battery and turn on battery switch. If battery low voltage, charge battery via external charger.
UPS No output	Light constantly	22	Overload	Check the loads and remove some non- critical loads. Check whether some loads are failed.
		23	Overheating	1)Check if the air intake and air outtake is blocked; 2) The ambient temperature is too high
		10	Output short	Remove all the loads. Turn off the UPS. Check whether the output of UPS and loads is short circuit. Make sure the short circuit is removed, and the UPS has no internal faults before turning on again.
Fail to transfer to online mode	Light circularly	31	Phase and neutral conductor at input of UPS system are reversed	Rotate mains power socket by 180° or connect UPS system.
		04/06/07	Input voltage/frequency/ earth connection abnormal	Check whether input voltage/frequency is abnormal, or earth connect correctly.

Event Name	Warning Icon 	Fault Code 	Possible cause	Remedy
Battery LED indicator light circularly	--	0b	Battery voltage is low	When audible alarm sounding every second, battery is almost empty.
Emergency supply period shorter than nominal value			Batteries not fully charged	Charge the batteries until the Batteries are fully charged
			Output overload	Check the loads and remove some non-critical loads. Check whether some loads are failed.
			Battery defect	Change the batteries or consult your dealer.
Bypass LED indicator light circularly	Light circularly	08	Bypass abnormal	Check whether bypass switch is turn to ON position.