

3W, wide input isolated & regulated dual / single output DC-DC converter

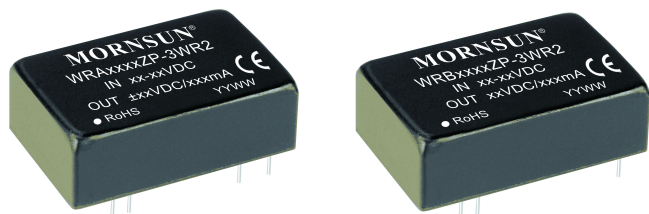

### FEATURES

- Wide input voltage range (2:1)
- High efficiency up to 86%
- Isolation voltage 1.5KVDC
- Output short circuit protection (automatic recovery)
- Operating temperature range: -40°C to +85°C
- Meet CISPR32/EN55032 CLASS A
- EN60950 approval

The WRA\_ZP-3WR2 & WRB\_ZP-3WR2 series are isolated 3W DC-DC products with 2:1 input voltage and conventional voltage output. The product has a relatively compact DIP package, and features high efficiency, operating temperature of -40°C to +85°C, remote control, and continuous short-circuit protection. The smaller size and fine cost design make the converter an ideal solution in communication, instruments, and industrial electronics applications.

### Selection Guide

Certification	Part No.	Input Voltage (VDC)		Output		Efficiency (% Min./Typ.) @ Full Load	Max. Capacitive Load <sup>2</sup> (μF)
		Nominal (Range)	Max. <sup>①</sup>	Output Voltage (VDC)	Output Current (mA) (Max./Min.)		
CE	WRA0505ZP-3WR2	5 (4.5-9)	11	±5	±300/±15	74/76	2200
	WRA0509ZP-3WR2			±9	±166/±8	74/76	1800
	WRA0512ZP-3WR2			±12	±125/±6	76/78	1800
	WRA0515ZP-3WR2			±15	±100/±5	76/78	1000
	WRB0505ZP-3WR2			5	600/30	72/74	4700
	WRB0512ZP-3WR2			12	250/12	75/77	2700
	WRB0515ZP-3WR2			15	200/10	75/77	2200
	WRA1205ZP-3WR2			12 (9-18)	20	±5	±300/±15
	WRA1209ZP-3WR2	±9	±166/±8			82/84	2000
	WRA1212ZP-3WR2	±12	±125/±6			82/84	1800
	WRA1215ZP-3WR2	±15	±100/±5			83/85	1000
	WRB1203ZP-3WR2	3.3	909/46			72/74	4700
	WRB1205ZP-3WR2	5	600/30			79/81	4700
	WRB1212ZP-3WR2	12	250/12			81/83	2700
	WRB1215ZP-3WR2	15	200/10			80/82	2200
	WRB1224ZP-3WR2	24	125/6	81/83	1800		
	WRA2405ZP-3WR2	24 (18-36)	40	±5	±300/±15	80/82	2200
	WRA2412ZP-3WR2			±12	±125/±6	82/84	1800
	WRA2415ZP-3WR2			±15	±100/±5	82/84	1000
	WRB2403ZP-3WR2			3.3	909/46	76/78	4700
	WRB2405ZP-3WR2			5	600/30	79/81	4700
	WRB2409ZP-3WR2			9	333/16	79/81	2700
	WRB2412ZP-3WR2			12	250/12	84/86	2700
	WRB2415ZP-3WR2			15	200/10	84/86	2200
WRB2424ZP-3WR2	24	125/6	83/85	1800			
WRA4805ZP-3WR2	48 (36-75)	80	±5	±300/±15	80/82	2200	
WRA4812ZP-3WR2			±12	±125/±6	82/84	1800	
WRA4815ZP-3WR2			±15	±100/±5	83/85	1000	
WRA4824ZP-3WR2			±24	±63/±3	82/84	680	
WRB4803ZP-3WR2			3.3	909/46	74/76	4700	
WRB4805ZP-3WR2			5	600/30	80/82	4700	

CE	WRB4812ZP-3WR2	48 (36-75)	80	12	250/12	84/86	2700
	WRB4815ZP-3WR2			15	200/10	84/86	2200
	WRB4824ZP-3WR2			24	125/6	82/84	1000

Notes:

- ① Exceeding the maximum input voltage may cause permanent damage;
- ② For the dual output modules, the capacitive loads of positive and negative outputs are the same.

### Input Specifications

Item	Operating Conditions	Min.	Typ.	Max.	Unit
Input Current (full load /no-load)	5VDC input	--	789/40	834/45	mA
	12VDC input	--	316/30	347/35	
	24VDC input	--	152/15	165/20	
	48VDC input	--	77/5	85/10	
Reflected Ripple Current	5VDC input	--	20	--	mA
	12VDC input	--	30	--	
	24VDC input	--	30	--	
	48VDC input	--	30	--	
Input impulse Voltage (1sec. max.)	5VDC input	-0.7	--	12	VDC
	12VDC input	-0.7	--	25	
	24VDC input	-0.7	--	50	
	48VDC input	-0.7	--	100	
Starting Voltage	5VDC input	--	--	4.5	VDC
	12VDC input	--	--	9	
	24VDC input	--	--	18	
	48VDC input	--	--	36	
Input Filter		Pi filter			
Hot Plug		Unavailable			

### Output Specifications

Item	Operating Conditions	Min.	Typ.	Max.	Unit	
Output Voltage Accuracy	5%-100% load	--	±1	±3	%	
No-load output Voltage Accuracy	Input voltage range	--	±1.5	±5		
Balance of Output Voltage	Dual output, balanced load	--	±0.5	±1		
Linear Regulation	Full load, the input voltage is from low voltage to high voltage	--	±0.2	±0.5		
Load Regulation	5%-100% load	--	±0.2	±0.5		
Transient Recovery Time	25% load step change	--	0.5	2	ms	
Transient Response Deviation		--	±2	±5	%	
Temperature Coefficient	Full load	--	±0.02	±0.03	%/°C	
Ripple & Noise*	20MHz bandwidth, nominal input voltage	24VDC output	--	100	120	mV p-p
		Others	--	50	80	
Short circuit Protection	Input voltage range	Continuous, self-recovery				

Note: \*Ripple and noise are measured by "parallel cable" method, please see DC-DC Converter Application Notes for specific operation.

### General Specifications

Item	Operating Conditions	Min.	Typ.	Max.	Unit
Isolation Voltage	Input-output, with the test time of 1 minute and the leak current lower than 1mA	1500	--	--	VDC
Insulation Resistance	Input-output, isolation voltage 500VDC	1000	--	--	MΩ
Isolation Capacitance	Input-output, 100KHz/0.1V	--	120	--	pF
Operating Temperature	Derating if the temperature is ≥85°C (see Fig. 1)	-40	--	85	°C
Storage Temperature		-55	--	125	
Casing Temperature Rise	Ta=25°C	--	25	--	

Pin Welding Resistance Temperature	Welding spot is 1.5mm away from the casing, 10 seconds	--	--	300	°C
Storage Humidity	Non-condensing	--	--	95	%RH
Switching Frequency(PFM mode)	100% load, nominal input voltage	--	200	--	KHz
MTBF	MIL-HDBK-217F@25°C	1000	--	--	K hours

Physical Specifications

Casing Material	Aluminum Alloy
Dimension	32.00*20.00*10.80 mm
Weight	14g(Typ.)
Cooling	Free air convection

EMC Specifications

EMI	CE	CISPR32/EN55032	CLASS A(Bare component) CLASS B (see Fig.3-② for recommended circuit)
	RE	CISPR32/EN55032	CLASS A(Bare component) CLASS B (see Fig.3-② for recommended circuit)
EMS	ESD	IEC/EN61000-4-2	Contact ±4KV perf. Criteria B
	RS	IEC/EN61000-4-3	10V/m perf. Criteria A
	EFT	IEC/EN61000-4-4	±2KV (see Fig.3-① for recommended circuit) perf. Criteria B
	Surge	IEC/EN61000-4-5	line to line ±2KV (see Fig.3-① for recommended circuit) perf. Criteria B
	CS	IEC/EN61000-4-6	3 Vr.m.s perf. Criteria A
	Voltage dips, short interruptions and voltage variations immunity	IEC/EN61000-4-29	0%, 70%

Product Characteristic Curve

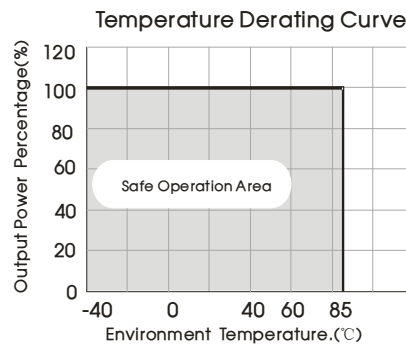
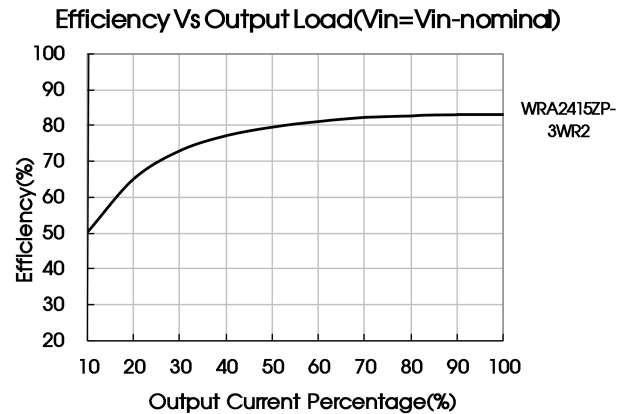
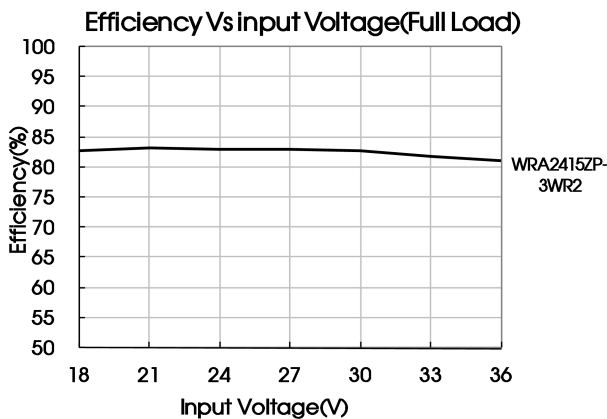
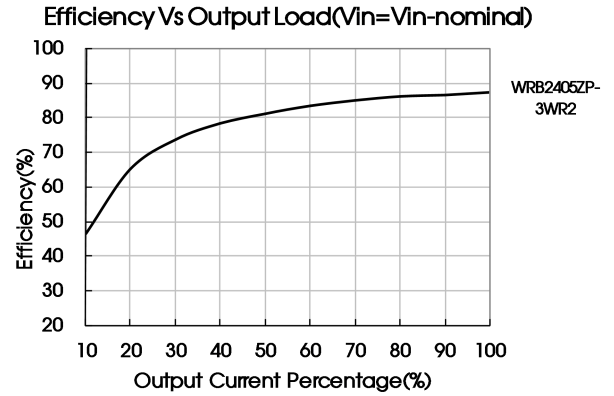
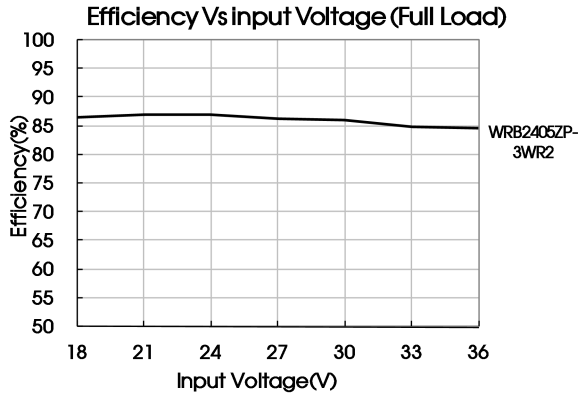

Fig. 1





## Design Reference

### 1. Output load requirements

To ensure that the module can work efficiently and reliably, its output min. load shall be no lower than 5% of the rated load when using, or the output ripple may increase rapidly. Ensure that the product working load must be higher than 5% of the rated load.

### 2. Typical application

All the DC/DC converters of this series are tested according to the recommended circuit (see Fig. 2) before delivery.

If it is required to further reduce input and output ripple, properly increase the input & output of additional capacitors  $C_{in}$  and  $C_{out}$  or select capacitors of low equivalent impedance provided that the capacitance is no larger than the max. capacitive load of the product.

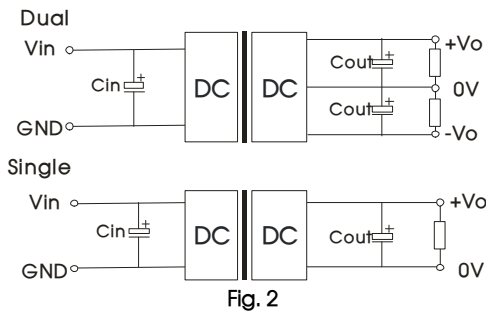

$V_{in}$	5V&12V	24V&48V
$C_{in}$	100 $\mu$ F	10 $\mu$ F~47 $\mu$ F
$C_{out}$	10 $\mu$ F	

### 3. EMC solution-recommended circuit

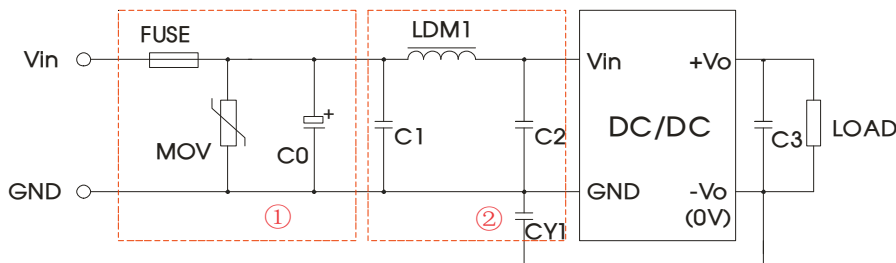

Fig. 3

Parameter description:

Model	Vin:5V	Vin:12V	Vin:24V	Vin:48V
FUSE	Slow blown fuses according to the actual input current selections of the clients			
MOV	--	S14K20	S20K30	S14K60
C0	1000µF/16V	1000µF/25V	330µF/50V	330µF/100V
C1	4.7µF/50V			4.7µF/100V
LDM1	12µH			
C2	4.7µF/50V			4.7µF /100V
C3	10µF			
CY1	1nF/2KV			

Note: ①.Part ① in the Fig. 3 is used for EMS test and part ② for EMI filtering, selected based on needs.  
②.If there is no recommended parameters, the model no require the external component.

#### 4. Input current

When the electricity is provided by the unstable power supply, please make sure that the range of the output voltage fluctuation and the ripple voltage of the power supply do not exceed the indicators of the modules. Input current of power supply should afford the flash startup current of this kind of DC/DC module(see Fig. 5).

Generally: Vin=5V Iave =1297mA  
 Vin=12V Iave=648mA  
 Vin=24V Iave=307mA  
 Vin=48V Iave =158mA

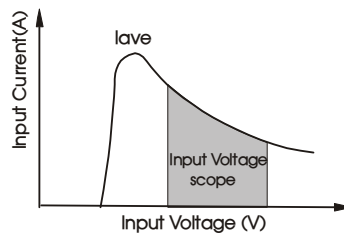
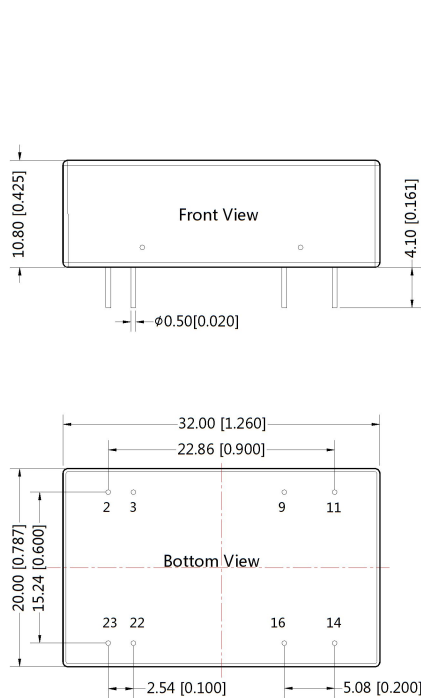

Fig. 5

5. For more information please find DC-DC converter application notes on [www.mornsun-power.com](http://www.mornsun-power.com)

Dimensions and Recommended Layout



Note:  
Unit :mm[inch]  
Pin diameter tolerances :±0.10[±0.004]  
Pin pitch tolerances: ±0.25[±0.010]  
General tolerances:±0.50[±0.020]

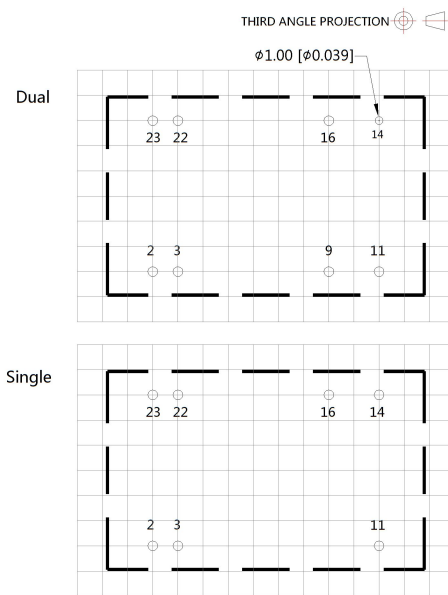

Note:Grid 2.54\*2.54mm

Pin-Out		
Pin	Single	Dual
2,3	GND	GND
9	No Pin	0V
11	NC	-Vo
14	+Vo	+Vo
16	0V	0V
22,23	Vin	Vin

NC: No Connection

Notes:

1. Packing information please refer to Product Packing Information which can be downloaded from [www.mornsun-power.com](http://www.mornsun-power.com). Packing bag number: 58210008;
2. Recommend to use module with more than 5% load, if not, the ripple of the product may exceeds the specification, but does not affect the reliability of the product;
3. The recommended unbalance degree of the dual output module load is  $\leq \pm 5\%$ ; if the degree exceeds  $\pm 5\%$ , than the product performance cannot be guaranteed to comply with all parameters in the datasheet. Please contact our technicians directly for specific information;
4. The maximum capacitive load offered were tested at nominal input voltage and full load;
5. Unless otherwise specified, parameters in this datasheet were measured under the conditions of  $T_a=25^\circ\text{C}$ , humidity<75%RH with nominal input voltage and rated output load;
6. All index testing methods in this datasheet are based on Company's corporate standards;
7. The performance parameters of the product models listed in this manual are as above, but some parameters of non-standard model products may exceed the requirements mentioned above. Please contact our technicians directly for specific information;
8. We can provide product customization service;
9. Specifications are subject to change without prior notice.

MORNSUN Guangzhou Science & Technology Co., Ltd.

Address: No. 5, Kehui St. 1, Kehui Development Center, Science Ave., Guangzhou Science City, Luogang District, Guangzhou, P. R. China  
Tel: 86-20-38601850-8801 Fax: 86-20-38601272 E-mail: info@mornsun.cn