

Data sheet

Connection line M12 plug straight - RJ45 plug straight 8-pole, X-coded 1.0 m

Page 1/6

P/N

142M2X15010

EAN 4250184158394

2018-01-03

Illustrations



Dimensional drawing

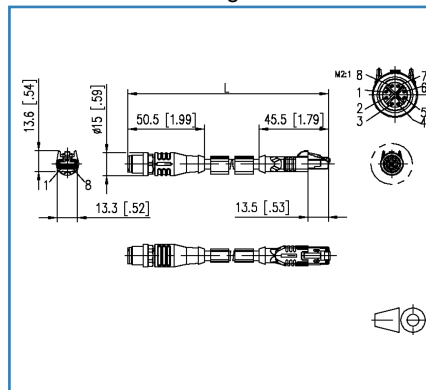

Wiring

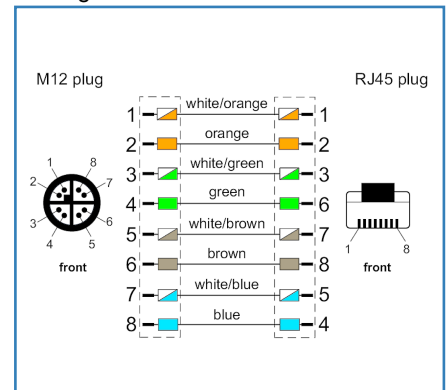

See enlarged drawings at the end of document

Product specification

- shielded M12-plug to RJ45-plug connection line
- Cat.6_A, 8-pole, X-coded
- side 1: M12-plug, straight
- side 2: RJ45-plug, straight
- connectors over molded
- stranded wires 4x2xAWG26/7 PiMF
- pin assignment per T568B
- overall shield tinned copper braid
- green cable, PUR
- standard variants: 1.0 m, 2.0 m, 5.0 m, 10.0 m
- other cable lengths on request

Data sheet

Page 2/6

Connection line M12 plug straight - RJ45 plug straight 8-pole, X-coded 1.0 m

P/N

142M2X15010

EAN 4250184158394

2018-01-03

Technical Data

General Data

Fields of application	Industrial Ethernet
Design	Ethernet-Connection line
Shielding	shielded
Transmission technology	Copper
Cable Type	S/FTP
Number of twisting elements	4
Twisting element	Pair
Wiring	1 - 1
Color coding fiber/ wire(s)	white/orange, orange, white/green, green, white/brown, brown, white/blue, blue
Color	green
Dimensions	
Dimension - Interface 1 (L x W x H)	50.50 x 15.00 x 15.00 mm
Dimension - Interface 1 (L x W x H)	1.988 x 0.591 x 0.591 in.
Dimension - Interface 2 (L x W x H)	45.50 x 13.30 x 13.60 mm
Dimension - Interface 2 (L x W x H)	1.791 x 0.524 x 0.535 in.
Cable length (m)	1.00 m
Labeling option	identification label carrier

Transmission characteristics

Category (ISO)	6 _A
----------------	----------------

Connections/interfaces

Connector technology interface 1	M12-plug
Connector technology interface 2	RJ45 plug
Coding interface 1	X-coded
Number of positions/contacts interface 1	8
Number of positions/contacts interface 2	8P/8C
Termination data, stranded wire (min. - max.)	
Conductor cross section, stranded wire	AWG 26/7
Conductor cross section, stranded wire	0.141 mm ²
Conductor diameter, stranded wire (bare copper)	0.483 mm
Conductor diameter, stranded wire (bare copper)	0.019 in.



Data sheet

Page 3/6

Connection line M12 plug straight - RJ45 plug straight 8-pole, X-coded 1.0 m

P/N

142M2X15010

EAN 4250184158394

2018-01-03

Technical Data

Connections/interfaces

Cable sheath diameter (min. - max.)

Cable sheath diameter 6.40 mm

Cable sheath diameter 0.236 in.

Electrical characteristics

Current carrying capacity 0.5 (M12), 1 (RJ45) A

Insulation resistance min. 100 MOhm

Mechanical characteristics

Maximum operating bending radius 64 mm

Maximum operating bending radius 2.52 in.

Maximum installation load 32 mm

Maximum installation load 1.26 in.

Shielding braid coverage 70 %

Materials and material properties

Material - Conductor Cu (copper)

Material - Conductor Insulation Polyethylen

Material - Cable jacket PUR

Material - Body interface 1 Plastics

Material - Body interface 2 Plastics

Material - Contact interface 1 CuZn (brass)

Material - Contact interface 2 CuZn (brass)

Material - Contact finish interface 1 Au (gold)

Material - Contact finish interface 2 Au (gold)

Material - Contact carriers interface 1 Plastics

Material - Contact carriers interface 2 Plastics

Material - Union nut interface 1 CuZn (brass)

Material - Union nut finish interface 1 Ni (nickel)

Material - Pair shield plastic film

Material - Pair shield finish Al (Aluminium)

Material - Main shield Cu (copper) braid

Material - Main shield finish Sn (tin)

Flame retardancy yes

Halogen free yes



Connection line M12 plug straight - RJ45 plug straight 8-pole, X-coded 1.0 m

P/N

142M2X15010

EAN 4250184158394

2018-01-03

Technical Data

Materials and material properties

Oil resistance	yes
UV-resistance	yes

Environmental conditions

Temperature (min. - max.)	
Temperature - Operating °C	-30 - 70 °C
Temperature - Operating °F	-22 - 158 °F
Particulate ingress interface 1	IP6X when plugged in
Liquid ingress/immersion interface 1	IPX5, IPX7 when plugged in
Particulate ingress interface 2	IP2X when plugged in
Liquid ingress/immersion interface 2	IPX0 when plugged in
Pollution degree interface 1	2
Pollution degree interface 2	1

Approvals

RoHS	compliant
------	-----------

The product meets the following standards

Connectors for electronic equipment	
Free and fixed connectors	IEC 60603-7-51
circular connector	DIN EN 61076-2-109
Multi-element metallic cables used in analogue and digital communication and control	DIN EN 50288-4-2
Test for vertical flame propagation for a single insulated wire or cable	DIN EN 60332-1-2
Measurement of smoke density of cables burning	IEC 61034

Classifications

ETIM 5.0	EC002599
ETIM 6.0	EC002599

Data sheet

Page 5/6

Connection line M12 plug straight - RJ45 plug straight 8-pole, X-coded 1.0 m

P/N

142M2X15010

EAN 4250184158394

2018-01-03

Technical Data

Packing details

Type of packaging	1 pc(s) / plastic bag
-------------------	-----------------------



**Connection line M12 plug straight - RJ45 plug straight
8-pole, X-coded 1.0 m**

P/N

142M2X15010

EAN 4250184158394

2018-01-03

Illustrations

Dimensional drawing

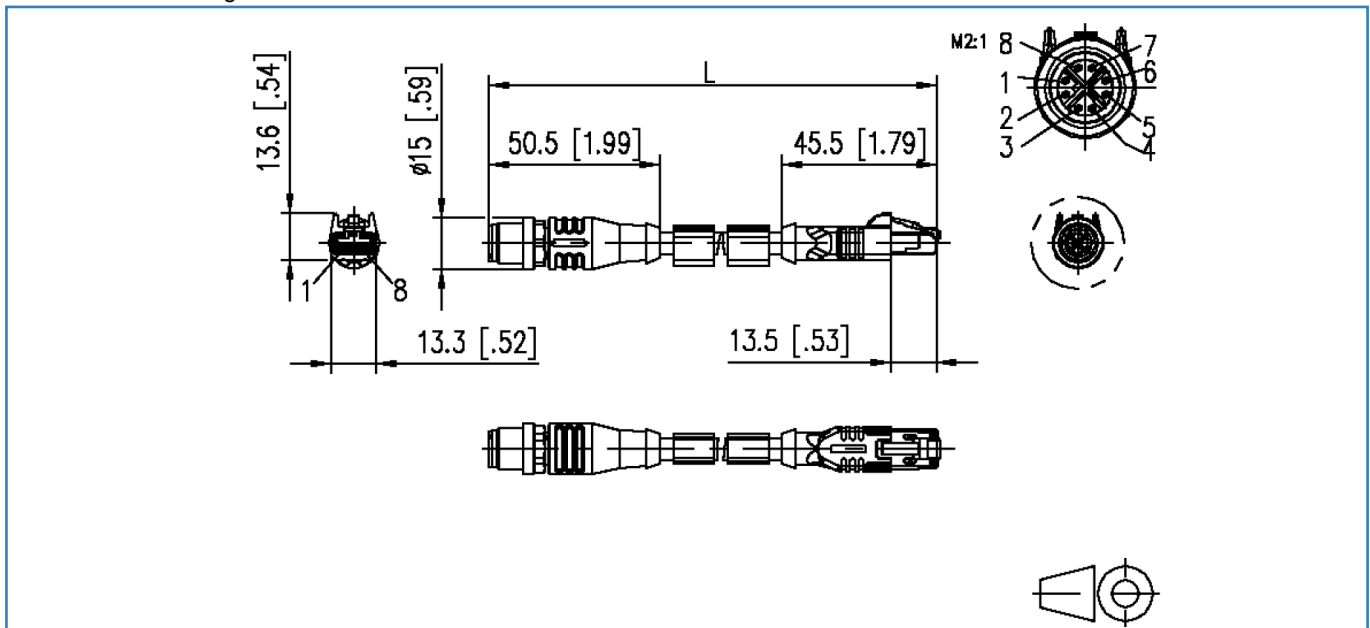

Wiring

