

TOSHIBA Bipolar Linear Integrated Circuit Silicon Monolithic

# TA7343AP

## FM PLL MPX

The TA7343AP is PLL FM stereo multiplex IC.  
It is suitable for automotive applications and portable radio applications because of space merit by the package and wide supply voltage range.

### Features

- Excellent stereo LED sensitivity  
:  $V_L$  (ON) = 9mV<sub>rms</sub> (typ.)
- Suitable for LED driving:  $I_{LED}$  = 20mA (max.)
- Recommendable input voltage range  
:  $V_{in}$  = 200~700mV<sub>rms</sub>
- Operating supply voltage range:  $V_{CC}$  = 3.5~12V
- Excellent channel separation through entire audio frequency range: Sep = 45dB (typ.)
- Low distortion: THD = 0.08% (typ.) at  $V_{in}$  = 200mV<sub>rms</sub> (stereo)
- Built-in compulsive monaural function. (The VCO is stopped when the pin(7) is connected with the power supply line, and then the stereo indicator is turn off.)
- Easy adjustment (the monitored free running frequency of VCO is 38kHz at pin(6).)

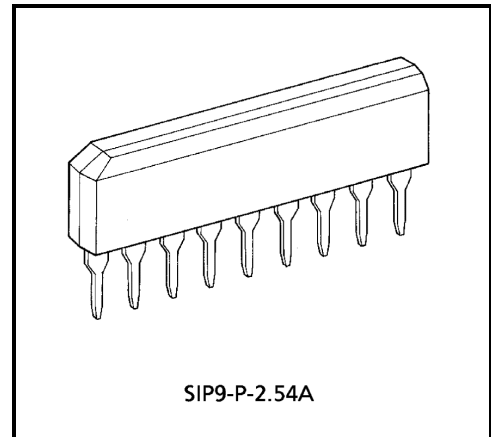

Weight: 0.92g (typ.)

## Block Diagram

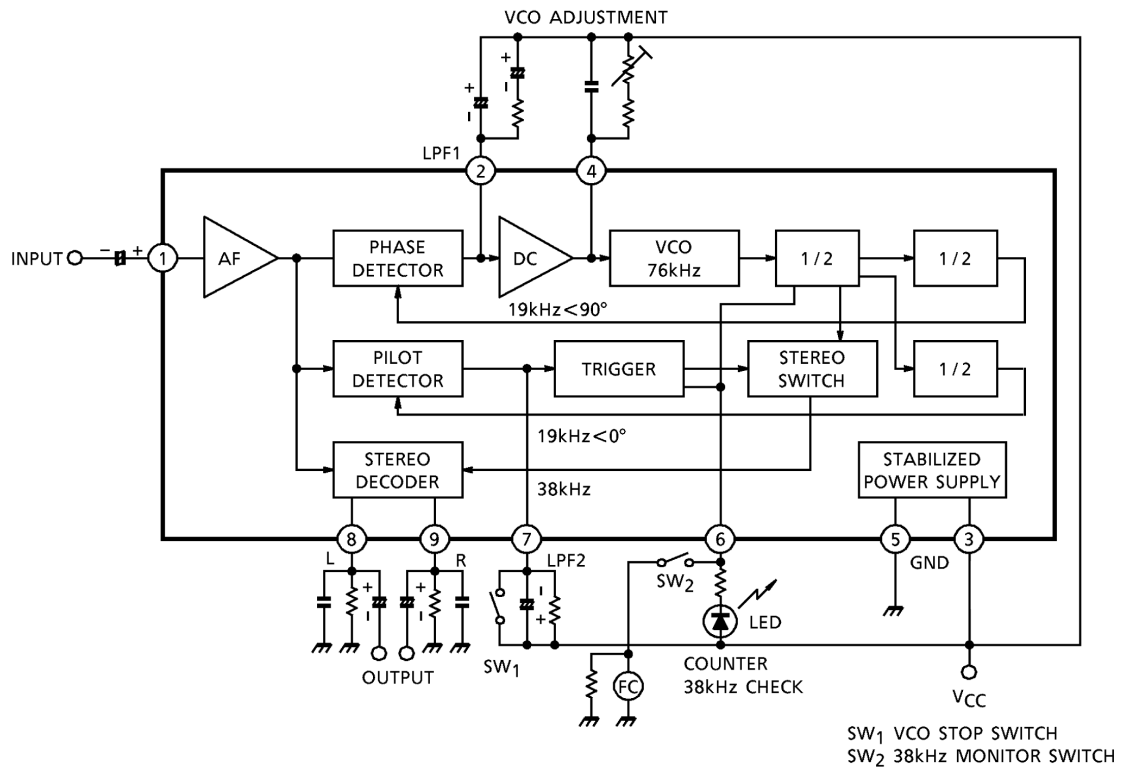

## Maximum Ratings (Ta = 25°C)

Characteristic	Symbol	Rating	Unit
Supply voltage	V <sub>CC</sub>	12	V
LED voltage	V <sub>LED</sub>	16	V
LED current	I <sub>LED</sub>	20	mA
Power dissipation	P <sub>D</sub> (Note)	500	mW
Operating temperature	T <sub>opr</sub>	-30~75	°C
Storage temperature	T <sub>stg</sub>	-55~155	°C

(Note) Derated above Ta = 25°C in the proportion of 4mW / °C

## Electrical Characteristics

1. DC Characteristics (Ta = 25°C, V<sub>CC</sub> = 8V, terminal voltage at no signal)

Pin No.	Characteristic	Symbol	Typ.	Unit
1	INPUT	V1	3.5	V
2	LPF 1	V2	6.6	V
3	V <sub>CC</sub>	V3	8.0	V
4	VCO	V4	7.1	V
5	GND	V5	0	V
6	ST LED	V6	—	V
7	LPF 2	V7	7.4	V
8	L-ch OUTPUT	V8	4.0	V
9	R-ch OUTPUT	V9	4.0	V

## 2. AC Characteristics (unless otherwise specified, $T_a = 25^\circ\text{C}$ , $V_{CC} = 8\text{V}$ , $f = 1\text{kHz}$ )

Characteristic		Symbol	Test Circuit	Test Condition	Min.	Typ.	Max.	Unit	
Supply current		$I_{CC}$	—	at LED off	—	11	18	mA	
Input resistance		$R_{IN}$	—		—	33	—	k $\Omega$	
Max. Composite signal input voltage		$V_{in}$ max (stereo)	—	L + R = 90%, P = 10% THD = 1%	—	900	—	mV <sub>rms</sub>	
Separation		Sep	—	L + R = 180mV <sub>rms</sub> P = 20mV <sub>rms</sub>	36	45	—	dB	
Total harmonic distortion	Monaural	THD (monaural)	—	$V_{in} = 200\text{mV}_{rms}$	—	0.08	0.3	%	
	Stereo	THD (stereo)	—	L + R = 180mV <sub>rms</sub> P = 20mV <sub>rms</sub>	—	0.08	—		
Voltage gain		$G_V$	—	$V_{in} = 200\text{mV}_{rms}$	-2.0	0	2.0	dB	
Channel balance		CB	—	$V_{in} = 200\text{mV}_{rms}$	—	0	1.5	dB	
Stereo LED sensitivity	On	$V_L$ (ON)	—	Pilot input	—	9	15	mV <sub>rms</sub>	
	Off	$V_L$ (OFF)	—		2	6	—		
Stereo LED hysteresis		$V_H$	—	To turn off from LED turn on	—	3	—	mV <sub>rms</sub>	
Capture range		CR	—	P = 20mV <sub>rms</sub>	—	$\pm 3$	—	%	
Carrier leak	19kHz	CL	—	P = 20mV <sub>rms</sub> L + R = 180mV <sub>rms</sub>	—	34	—	dB	
	38kHz				—	42	—		
SCA rejection ratio		SCA rej	—	P = 20mV <sub>rms</sub> L + R = 160mV <sub>rms</sub> SCA = 20mV <sub>rms</sub> $f_{SCA} = 67\text{kHz}$	—	70	—	dB	
Signal to noise ratio		S / N	—	$V_{in} = 200\text{mV}_{rms}$ $f = 1\text{kHz}$ , $R_g = 620\Omega$	—	74	—	dB	
Output current (Pin(8), Pin(9))		$I_{OUT}$	—	$R_L = 3.3\text{k}\Omega$	$V_{CC} = 3.5\text{V}$	—	0.3	0.6	mA
					$V_{CC} = 8.0\text{V}$	—	1.2	1.8	
					$V_{CC} = 12\text{V}$	—	1.4	2.1	

## Test Circuit

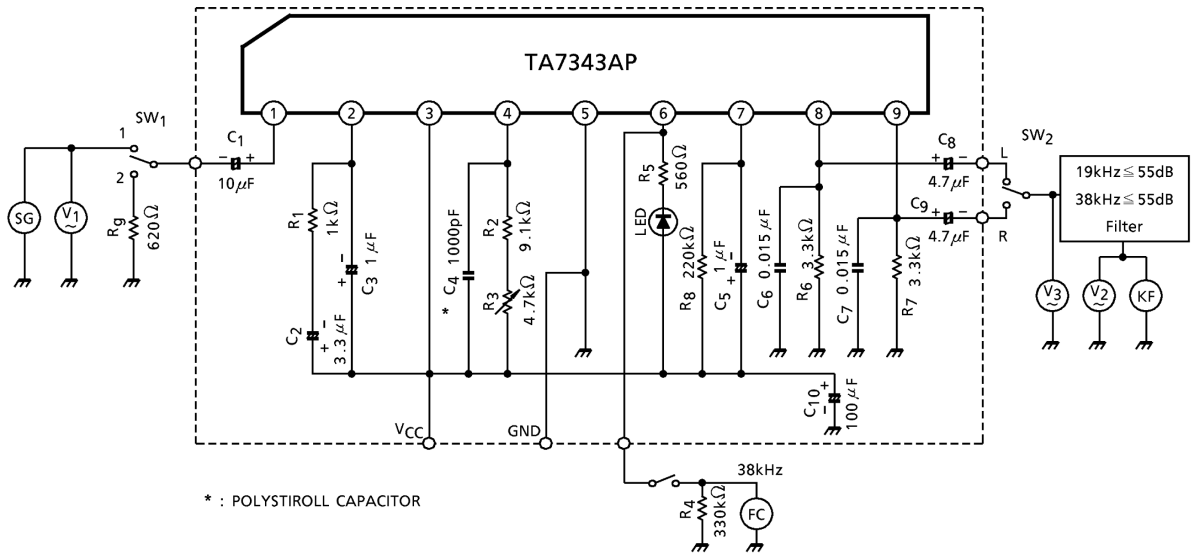

- SG : STEREO SIGNAL GENERATOR
- FC : FREQUENCY COUNTER
- V<sub>1</sub>, V<sub>2</sub>, V<sub>3</sub> : AC VOLTMETER
- KF : DISTORTION METER

## External Parts Table

Parts No.	Typical	Purpose	Influence		Note
			Smaller than typ.	Greater than typ.	
C <sub>1</sub>	10μF	Coupling	Separation is bad at 50~300Hz	"POP" noise is high	Input
C <sub>2</sub>	3.3μF	LPF at PLL	THD is bad at 5~10kHz (stereo)	Narrow capture range	—
C <sub>3</sub>	1μF				
R <sub>1</sub>	1kΩ				
C <sub>4</sub>	1000pF	VCO free running frequency adjustment	C <sub>4</sub> : Small → wide capture range and large glitter		—
R <sub>2</sub>	9.1kΩ		C <sub>4</sub> : Large → narrow capture range		
R <sub>3</sub>	4.7kΩVR				
R <sub>4</sub>	330kΩ	Monitor load	—		—
R <sub>5</sub>	560Ω	Rush current limiter	IC is damaged by the rush current	LED is dark	I <sub>LED</sub> ≤ 20mA
LED	—	Stereo indicator	Usable for LED		
C <sub>6</sub>	0.015μF	Load and diemphasis	Diemphasis (50μs)		C <sub>6</sub> = 0.022μF for 75μs
R <sub>6</sub>	3.3kΩ		Output voltage is small	THD is bad for low V <sub>CC</sub>	
C <sub>7</sub>	0.015μF	Load and diemphasis	Diemphasis (50μs)		C <sub>7</sub> = 0.022μF for 75μs
R <sub>7</sub>	3.3kΩ		Output voltage is small	THD is bad for low V <sub>CC</sub>	
C <sub>8</sub>	4.7μF	Output coupling	Frequency response is bad	"POP" noise is large	L-ch
C <sub>9</sub>	4.7μF	Output coupling			R-ch
R <sub>8</sub>	220kΩ	LED sensitivity adjustment	V <sub>L</sub> (ON) is large	V <sub>L</sub> (ON) is small	—
C <sub>5</sub>	1μF	LPF at LED	THD is bad at 50~300Hz	Slow LED response	—

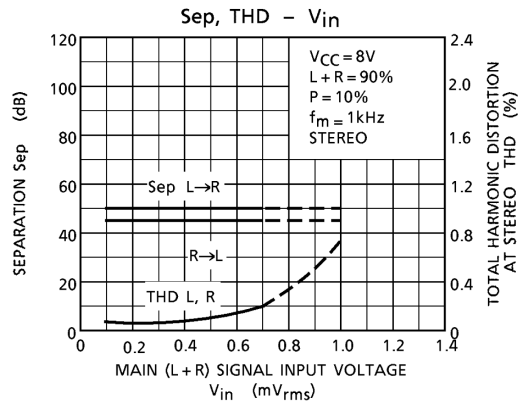
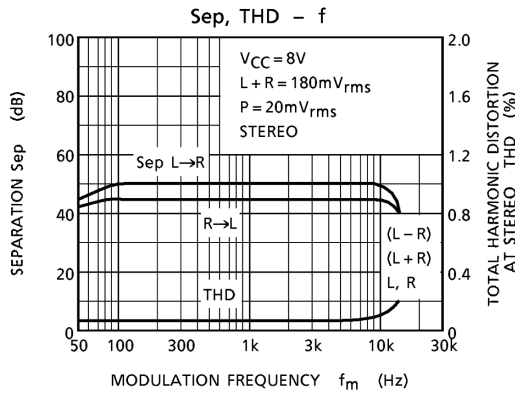
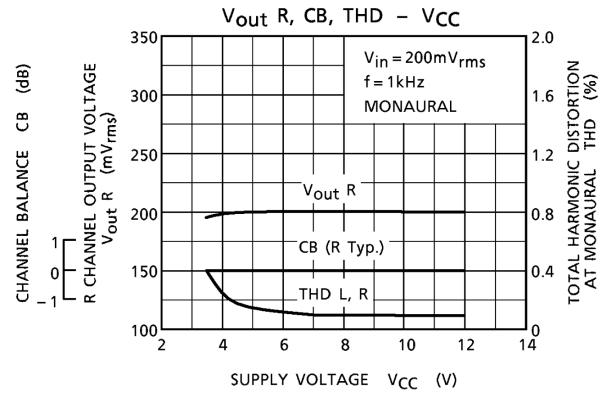
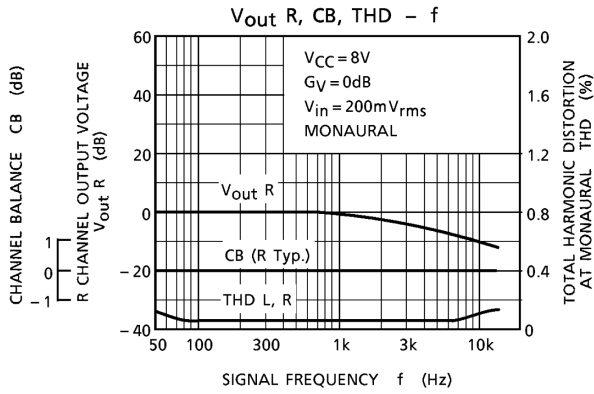
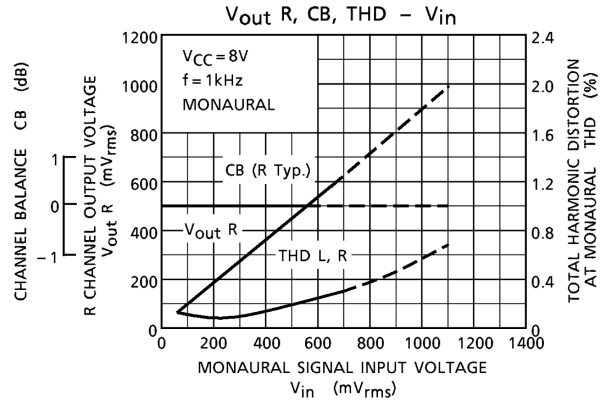
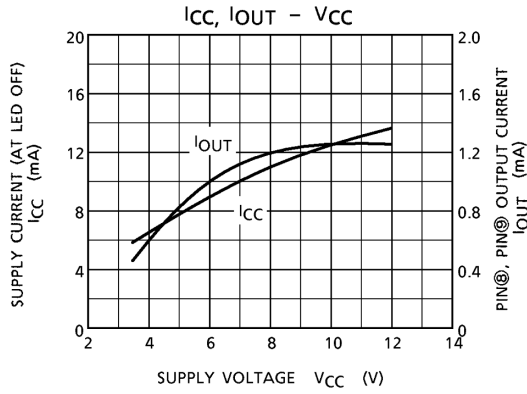

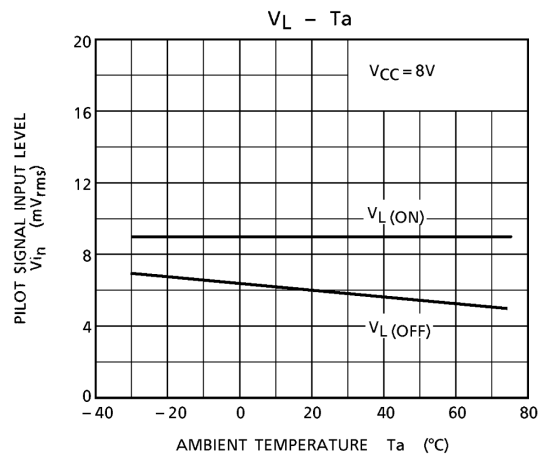
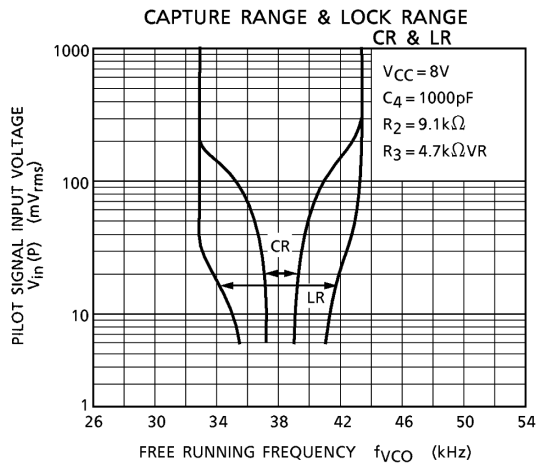
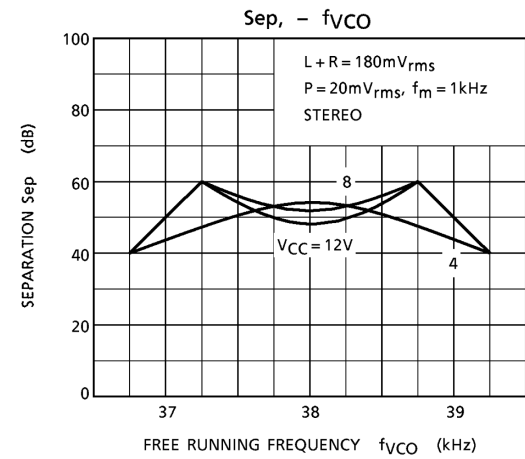
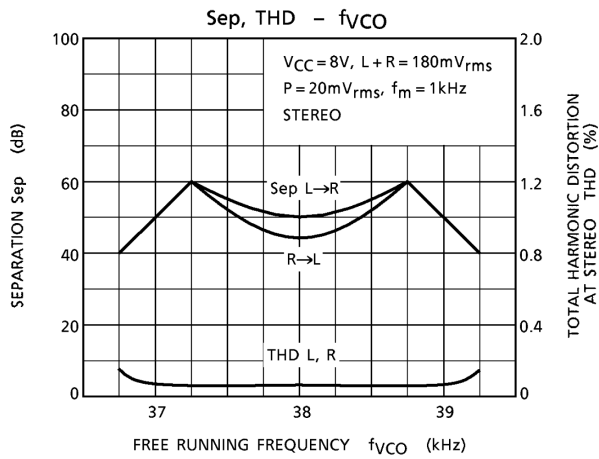
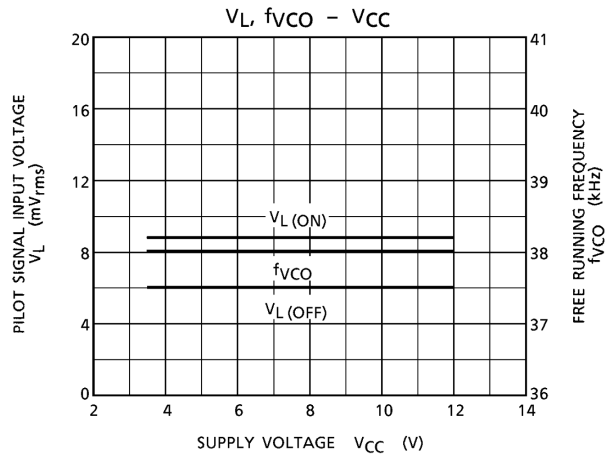
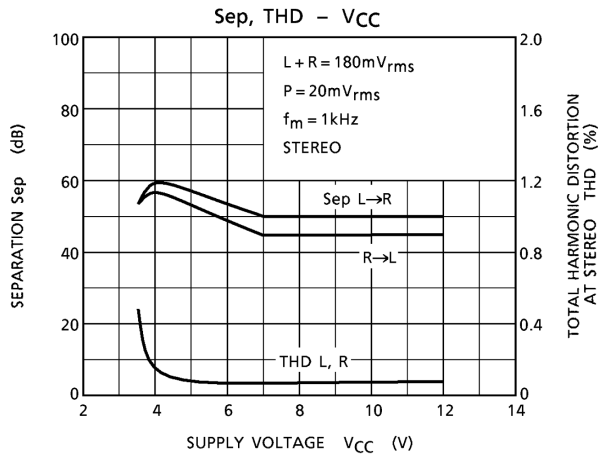



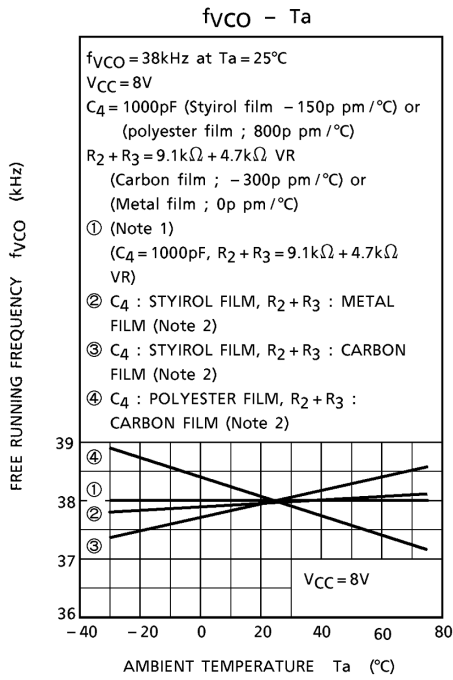
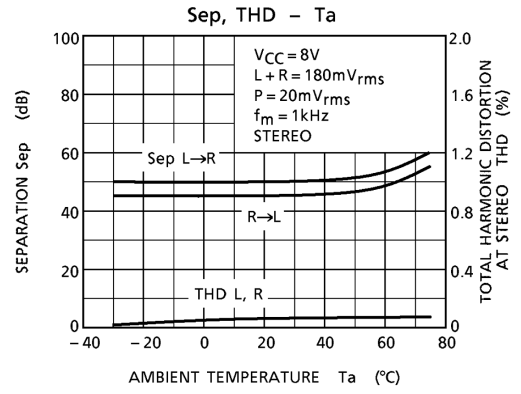
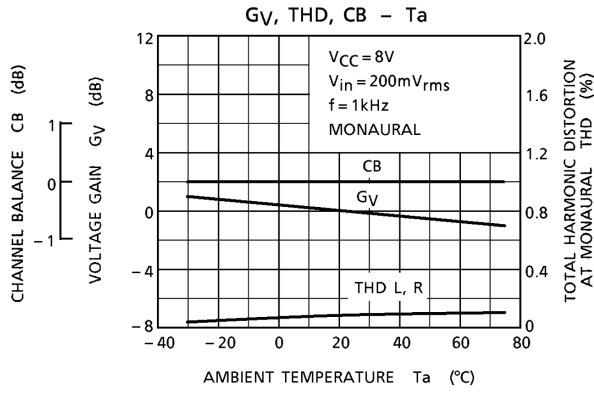

(Note 1) ① : With IC only put into a temperature test chamber

(Note 2) ②③④ : With IC, resistors and capacitors put into a temperature test chamber

## Package Dimensions

SIP9-P-2.54A

Unit : mm

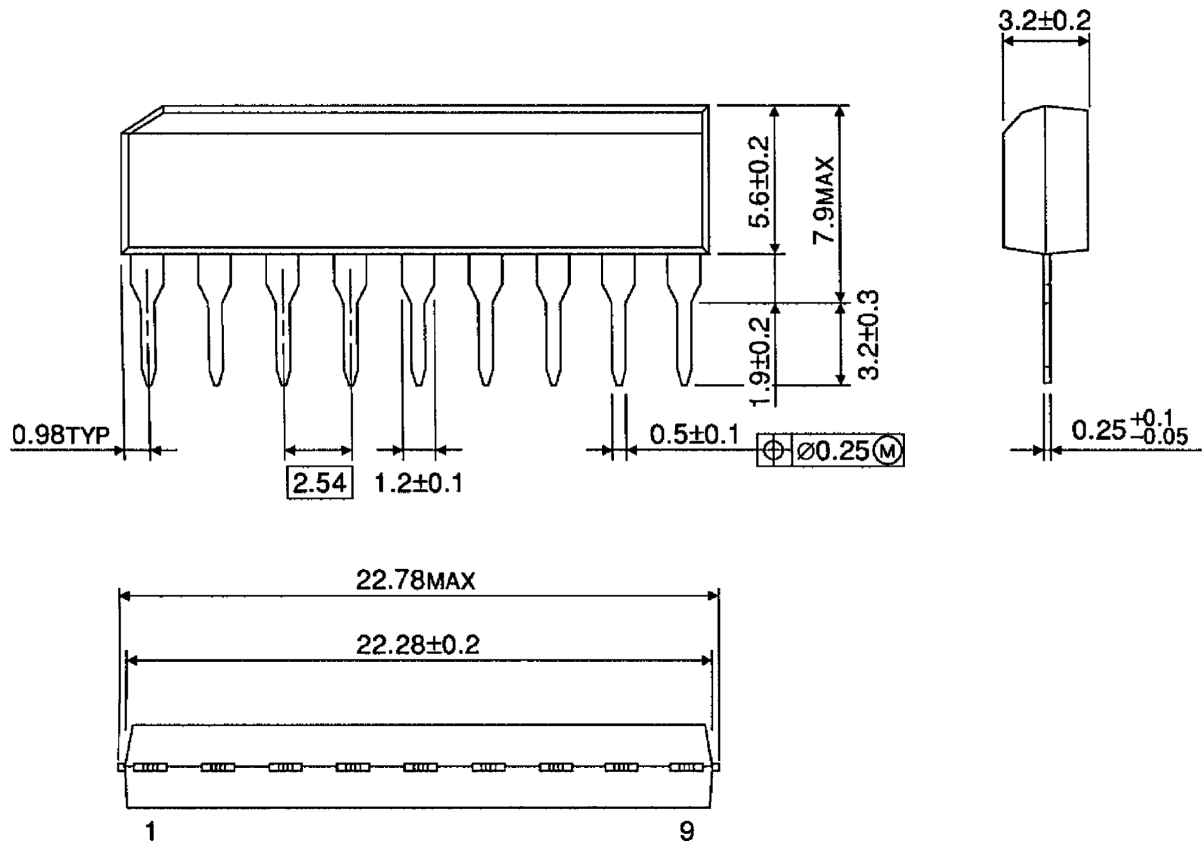

Weight: 0.92g (typ.)

**RESTRICTIONS ON PRODUCT USE**

000707EBA

- TOSHIBA is continually working to improve the quality and reliability of its products. Nevertheless, semiconductor devices in general can malfunction or fail due to their inherent electrical sensitivity and vulnerability to physical stress. It is the responsibility of the buyer, when utilizing TOSHIBA products, to comply with the standards of safety in making a safe design for the entire system, and to avoid situations in which a malfunction or failure of such TOSHIBA products could cause loss of human life, bodily injury or damage to property.  
In developing your designs, please ensure that TOSHIBA products are used within specified operating ranges as set forth in the most recent TOSHIBA products specifications. Also, please keep in mind the precautions and conditions set forth in the "Handling Guide for Semiconductor Devices," or "TOSHIBA Semiconductor Reliability Handbook" etc..
- The TOSHIBA products listed in this document are intended for usage in general electronics applications (computer, personal equipment, office equipment, measuring equipment, industrial robotics, domestic appliances, etc.). These TOSHIBA products are neither intended nor warranted for usage in equipment that requires extraordinarily high quality and/or reliability or a malfunction or failure of which may cause loss of human life or bodily injury ("Unintended Usage"). Unintended Usage include atomic energy control instruments, airplane or spaceship instruments, transportation instruments, traffic signal instruments, combustion control instruments, medical instruments, all types of safety devices, etc.. Unintended Usage of TOSHIBA products listed in this document shall be made at the customer's own risk.
- The products described in this document are subject to the foreign exchange and foreign trade laws.
- The information contained herein is presented only as a guide for the applications of our products. No responsibility is assumed by TOSHIBA CORPORATION for any infringements of intellectual property or other rights of the third parties which may result from its use. No license is granted by implication or otherwise under any intellectual property or other rights of TOSHIBA CORPORATION or others.
- The information contained herein is subject to change without notice.