

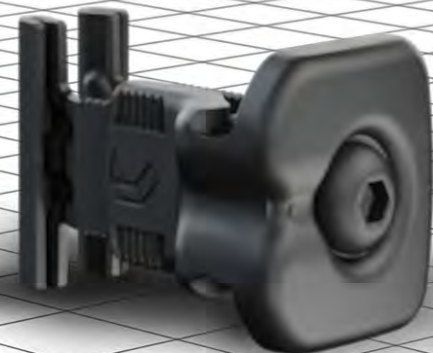

**Renusol**  
Europe GmbH

PRODUKTKATALOG  
PRODUCT CATALOG

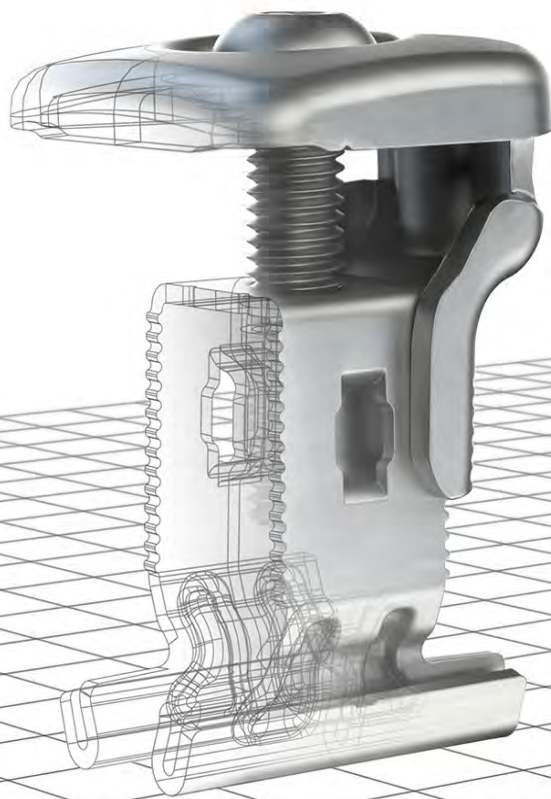

## DE | Produktkatalog

Gültig ab 22.06.2021 - 01.01.2022

Abbildungen und Texte dienen der Präsentation der Ware.

Änderungen und Irrtümer bleiben bis zur Abgabe der Bestellung durch den Kunden vorbehalten.

Preise ab Lager

## GB | Product catalogue

Valid starting 22.06.2021 - 01.01.2022

Illustrations and texts are used to present the product.

No liability is accepted for changes and errors made before the customer has placed an order.

Price ex works

## FR | Catalogue de produits

Valable à partir du 22.06.2021 - 01.01.2022

Les images et les textes servent à la présentation des produits.

Sous réserve de modifications et d'erreurs jusqu'à la passation de commande par le client.

Prix ex usine

## IT | Catalogo prodotti

Valido dal 22.06.2021 - 01.01.2022

Le figure e i testi sono indicativi.

Con riserva di modifica e di errore fino all'avvenuta ordinazione da parte del cliente.

Il prezzo franco fabbrica

## ES | Catálogo de productos

Válido a partir del 22.06.2021 - 01.01.2022

Las imágenes y textos están destinados a la presentación de la mercancía.

Nos reservamos el derecho a modificaciones y errores hasta la entrega del pedido por parte del cliente

El precio en fábrica



DE		Schrägdach	MS+ / MS+P / VS+
EN		Pitched-roof	MS+ / MS+P / VS+
FR		Toiture inclinée	MS+ / MS+P / VS+
IT		Tetti inclinati	MS+ / MS+P / VS+
ES		Tejado oblicuo	MS+ / MS+P / VS+



DE		Flachdach	FS10-EW / FS-S / CS+
EN		Flat-roof	FS10-EW / FS-S / CS+
FR		Toitures plates	FS10-EW / FS-S / CS+
IT		Tetti piani	FS10-EW / FS-S / CS+
ES		Tejado plano	FS10-EW / FS-S / CS+



DE		Indach	ISSE
EN		In-roof	ISSE
FR		Intégration	ISSE
IT		Integrazione	ISSE
ES		Integrado en cubierta	ISSE



DE		Zubehör
EN		Accessoires
FR		Accessoires
IT		Accessori
ES		Accesorio



DE		Muster
EN		Samples
FR		Echantillo
IT		Campioatura
ES		Muestra



DE		Aktualisierte Information
EN		Updated information
FR		Informations mises à jour
IT		Informazioni aggiornate
ES		Información actualizada









DE		Neues Produkt
EN		New product
FR		Nouveau produit
IT		Nuovo prodotto
ES		Producto nuevo

# DEDICATED TO METAL



***MS+/MS+ P***



	D MetaSole+ Blechstärke Stahl 0,40-1,25 mm; Alu 0,50-2,00 mm	Item No. 420402
	UK MetaSole+ metal sheet thickness: steel 0.40-1.25mm; alu 0.50-2.00 mm	
	F MetaSole+ Epaisseur de tôle; acier 0,40 - 1,25 mm; alu 0,50 - 2,00 mm	
	I MetaSole+ Spessore lamiera; acciaio 0,40 - 1,25 mm; allu 0,50 - 2,00 mm	
	E MetaSole+ Grosiores: acero 0,40 - 1,25 mm; alu 0,50 - 2,00 mm	
	D MetaSole+ Blechstärke: Stahl 0,75-1,00 mm	Item No. 420403
	UK MetaSole+ metal sheet thickness: steel 0.75-1.0 mm	
	F MetaSole+ Epaisseur de tôle: acier 0,75 - 1,00 mm	
	I MetaSole+ Spessore lamiera: acciaio 0,75 - 1,00 mm	
	E MetaSole+ Grosiores: acero 0,75 - 1,00 mm	
	D MetaSole+ Blechstärke: Stahl 0,75 ETN Zertifikat	Item No. 420405
	UK MetaSole+ metal sheet thickness: steel 0.75 ETN Certification	
	F MetaSole+ Epaisseur de tôle: acier 0,75 mm; Certification ETN	
	I MetaSole+ Spessore lamiera: acciaio 0,75 mm; Certificato ETN	
	E MetaSole+ Grosiores: acero 0,75 mm; certificación ETN	
	D MetaSole+ Klemmfuß mit Nieten ab 0,50 - 2,00 mm	Item No. 420406
	UK MetaSole+ foot with rivets from 0.50 - 2,00 mm	
	F MetaSole+ pied avec rivets 0,50 - 2,00 mm	
	I MetaSole+ piede con rivetti 0,50 - 2,00 mm	
	E MetaSole+ pie con remaches 0,50 - 2,00 mm	
	D MS+ Adapter Wellblech Radius 24	Item No. 420401
	UK MS+ Adapter corrugated sheet radius 24	
	F MS+ Adaptateur tôle ondulée rayon 24	
	I MS+ Adattatore lamiera ondulata raggio 24	
	E MS+ Adaptador chapa ondulada radio 24	
	D MS+ Wellblech Radius 24	Item No. 420411
	UK MS+ corrugated sheet radius 24	
	F MS+ tôle ondulée rayon 24	
	I MS+ lamiera ondulata raggio 24	
	E MS+ chapa ondulada radio 24	
	D MS+ Portrait (Set)	Item No. 420420
	UK MS+ Portrait (Set)	
	F MS+ Portrait	
	I MS+ Verticale	
	E MS+ Formato alto	
	D MS+ Portrait Niete (Set)	Item No. 420422
	UK MS+ Portrait Rivet (Set)	
	F MS+ Portrait rivets (SET)	
	I MS+ Verticale rivetti (SET)	
	E MS+ Formato alto remanches (SET)	



	D MS+ Portrait 400 mm (Set)	Item No. 420421
	UK MS+ Portrait 400 mm (Set)	
	F MS+ Portrait 400 mm	
	I MS+ Verticale 400 mm	
	E MS+ Formato alto 400 mm	
	D MS+ Portrait 3600mm ohne EPDM	Item No. 400405
	UK MS+ Portrait 3600 mm without EPDM	
	F MS+ Portrait 3600 mm sans EPDM	
	I MS+ Verticale 3600 mm senza EPDM	
	E MS+ Formato alto 3600 mm sin EPDM	
	D MS+ Portrait 4200 mm ohne EPDM	Item No. 400406
	UK MS+ Portrait 4200 mm without EPDM	
	F MS+ Portrait 4200 mm sans EPDM	
	I MS+ Verticale 4200 mm senza EPDM	
	E MS+ Formato alto 4200 mm sin EPDM	
	D MS+ H (Set)	Item No. 420423
	UK MS+ H (Set)	
	F MS+ H (Set)	
	I MS+ H (Set)	
	E MS+ H (Set)	
	D EPDM Rolle 5m für MS+ Portrait	Item No. 300224
	UK EPDM Roll 5m for MS+ Portrait	
	F Rouleau EPDM 5 m pour MS+ Portrait	
	I Rotolo EPDM 5 m per MS+ Verticale	
	E Rollo EPDM 5m para MS+ Formato alto	
	D Bohrschraube 5,5 x 25 SW8 E16	Item No. 400301
	UK Self drilling screw 5,5 x 25 SW8 E16	
	F Vis autoforeuse 5,5 x 25 SW8 E16	
	I Vite autoforante 5,5 x 25 SW8 E16	
	E Tornillo taladrador 5,5 x 25 SW8 E16	
	D Bohrschraube SFS-SDK2-S-377-6,0x35	Item No. 400047
	UK Self drilling screw SFS-SDK2-S-377- 6,0x35	
	F Vis autoforeuse SFS-SDK2-S-377- 6,0x35	
	I Vite autoforante SFS-SDK2-S-377- 6,0x35	
	E Tornillo taladrador SFS-SDK2-S-377- 6,0x35	
	D Bohrschraube Faynot P1 6,3 x 38	Item No. 900122
	UK Self drilling screw Faynot P1 6,3 x 38	
	F Vis autoforeuse Faynot P1 6,3 x 38	
	I Vite autoforante Faynot P1 6,3 x 38	
	E Tornillo taladrador Faynot P1 6,3 x 38	



**D** Niete 6,4x14

**UK** Rivets 6,4x14

**F** Rivets 6,4x14

**I** Rivetti 6,4x14

**E** Remaches 6,4x14

Item No.

900270





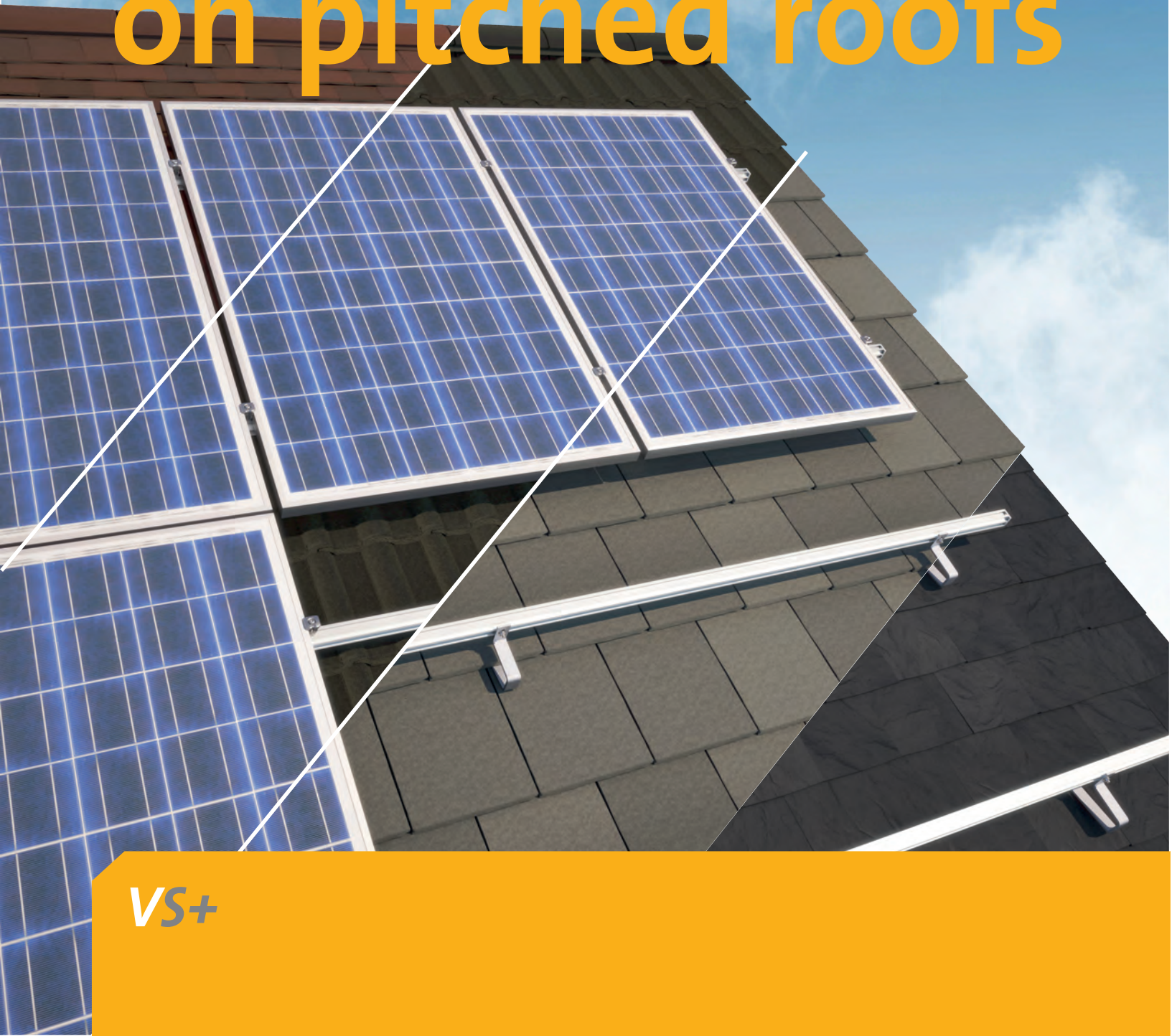





# VS+ Allrounder on pitched roofs



**VS+**













	D Dachhaken Aluminium Standard (ohne Holzschraube)	Item No. 420151
	UK Roof hook aluminium (without wood screw)	
	F Crochet de toit aluminium (sans vis)	
	I Staffa alluminio (senza vite da legno)	
	E Gancho salvatejas Aluminio (sin tornillo de madera)	
	D Dachhaken Aluminium verstellbar 100mm (ohne Holzschraube)	Item No. 420161
	UK Roof hook aluminium adjustable 100 mm (without wood screw)	
	F Crochet de toit aluminium réglable 100 mm (sans vis)	
	I Staffa alluminio. regolabile 100 mm (senza vite da legno)	
	E Gancho salvatejas Aluminio ajustable 100 mm (sin tornillo de madera)	
	D Dachhaken Aluminium Beton Basic 90°	Item No. 920003
	UK Roof hook Alu Concrete Basic 90°	
	F Crochet de toit aluminium béton basic 90°	
	I Staffa alluminio Calcestruzzo 90°	
	E Gancho salvatejas Aluminio Hormigón 90°	
	D Dachhaken Edelstahl (ohne Holzschraube)	Item No. 420150
	UK Roof hook stainless steel (without wood screw)	
	F Crochet de toit acier inoxydable (sans vis)	
	I Staffa acciaio inossidabile (senza vite da legno)	
	E Gancho salvatejas acero inoxidable (sin tornillo de madera)	
	D Dachhaken Biber Standard (ohne Holzschraube)	Item No. 420153
	UK Roof hook for plain tiles Standard (without wood screw)	
	F Crochet de toit tuile plate standard (sans vis)	
	I Staffa Coda di castoro Standard (senza vite da legno)	
	E Gancho para tejas planas estándar (sin tornillo de madera)	
	D Dachhaken Biber 90° (ohne Holzschraube)	Item No. 420154
	UK Roof hook for plain tiles 90° (without wood screw)	
	F Crochet de toit tuile plate 90° (sans vis)	
	I Staffa Coda di castoro 90° (senza vite da legno)	
	E Gancho para tejas planas 90° (sin tornillo de madera)	
	D Dachhaken Schiefer (ohne Holzschraube)	Item No. 420155
	UK Roof hook for slate tiles (without wood screw)	
	F Crochet de toit ardoise (sans vis)	
	I Staffa Ardesia (senza vite da legno)	
	E Gancho para tejas de pizarra (sin tornillo de madera)	
	D Dachhaken Edelstahl Aufdachdämmung (ohne Holzschraube)	Item No. 420160
	UK Roof hook stainless steel on-roof insulation (without wood screw)	
	F Crochet en acier inox pour toiture avec isolation (sans vis)	
	I Staffa acciaio inossidabile per tetto con isolamento (senza vite)	
	E Gancho salvatejas para aislamiento sobre cubierta (sin tornillo)	



	<b>D</b> Dachhaken UK Dachpfanne (ohne Holzschraube)	<b>Item No.</b> 420180
	<b>UK</b> Roof hook UK Pantile (without wood screw)	
	<b>F</b> Crochet de toit UK tuile (sans vis)	
	<b>I</b> Staffa tegola UK, staffa (senza vite da legno)	
	<b>E</b> Gancho para cubierta de tejas UK (sin tornillo de madera)	
	<b>D</b> Dachhaken UK Biber/Schiefer (ohne Holzschraube)	<b>Item No.</b> 420181
	<b>UK</b> Roof hook UK Plain tiles/slates (without wood screw)	
	<b>F</b> Crochet de toit UK tuile plate/ardoise (sans vis)	
	<b>I</b> Staffa tegole piane/ardesia UK (senza vite da legno)	
	<b>E</b> Gancho para cubierta de pizarra UK (sin tornillo de madera)	
	<b>D</b> Dachhaken UK Biber/Schiefer HL (ohne Holzschraube)	<b>Item No.</b> 420184
	<b>UK</b> Roof hook UK Plain tiles/slates HL (without wood screw)	
	<b>F</b> Crochet de toit UK tuile plate/ardoise HL (sans vis)	
	<b>I</b> Staffa tegole piane/ardesia UK HL (senza vite da legno)	
	<b>E</b> Gancho para cubierta de pizarra UK HL (sin tornillo de madera)	
	<b>D</b> Dachhaken UK Flexibel (ohne Holzschraube)	<b>Item No.</b> 420182
	<b>UK</b> Roof hook UK Flexible (without wood screw)	
	<b>F</b> Crochet de toit UK flexible (sans vis)	
	<b>I</b> Staffa UK flessibile (senza vite da legno)	
	<b>E</b> Gancho para cubierta flexible UK (sin tornillo de madera)	
	<b>D</b> Dachhaken UK Flexibel 90° (ohne Holzschraube)	<b>Item No.</b> 420183
	<b>UK</b> Roof hook UK Flexible 90° (without wood screw)	
	<b>F</b> Crochet de toit UK flexible 90° (sans vis)	
	<b>I</b> Staffa UK flessibile 90° (senza vite da legno)	
	<b>E</b> Gancho para cubierta flexible UK 90° (sin tornillo de madera)	
	<b>D</b> Dachhaken ECO Basic (ohne Holzschraube)	<b>Item No.</b> 420165
	<b>UK</b> Roof hook ECO Basic (without wood screw)	
	<b>F</b> Crochet de toit ECO Basic (sans vis)	
	<b>I</b> Staffa Eco Basic (senza vite de lengo))	
	<b>E</b> Gancho para cubierta Eco Basic (sin tornillo de madera)	
	<b>D</b> Dachhaken ECO High (ohne Holzschraube)	<b>Item No.</b> 420166
	<b>UK</b> Roof hook ECO High (without wood screw)	
	<b>F</b> Crochet de toit ECO High (sans vis)	
	<b>I</b> Staffa Eco High (senza vite de lengo))	
	<b>E</b> Gancho para cubierta Eco High (sin tornillo de madera)	
	<b>D</b> Dachhaken HL (ohne Holzschraube)	<b>Item No.</b> 420170
	<b>UK</b> Roof hook HL (without wood screw)	
	<b>F</b> Crochet de toit HL (sans vis)	
	<b>I</b> Staffa HL (senza vite de lengo)	
	<b>E</b> Gancho para cubierta HL (sin tornillo)	



	D	Dachhaken Edelstahl Tegola Portughese (ohne Holzschraube)	Item No.	420158
	UK	Roof hook stainless steel Tegola Portughese (without wood screw)		
	F	Crochet de toit acier inoxydable Tegola Portughese (sans vis)		
	I	Staffa acciaio inossidabile Tegola Portughese (senza vite da legno)		
	E	Gancho salvatejas acero inoxidable Tegola Portughese (sin tornillos)		
	D	Distanzplatte 2 mm	Item No.	400350
	UK	2-mm spacer plate		
	F	Plaque d'écartement 2 mm		
	I	Piastra distanziale 2mm		
	E	Placa calzadora 2 mm		
	D	Distanzplatte 5 mm	Item No.	400351
	UK	5-mm spacer plate		
	F	Plaque d'écartement 5 mm		
	I	Piastra distanziale 5mm		
	E	Placa calzadora 5 mm		
	D	Holzbohrschraube Linsenkopf 6 x 80/74	Item No.	900305
	UK	Wood screw pan head 6 x 80/74		
	F	Vis à bois tête lenticulaire 6 x 80/74		
	I	Vite da legno testa tonda 6 x 80/74		
	E	Tornillo madera con cabeza convexa 6 x 80/74		
	D	Holzschraube Senkkopf für Schieferdachhaken 6 x 80	Item No.	900013
	UK	Wood screw countersunk 6 x 80		
	F	Vis à bois tête fraisée 6 x 80 pour ardoises		
	I	Vite da legno testa piana per ardesia 6 x 80		
	E	Tornillo madera para teja planas cabeza avellanada 6 x 80		
	D	Holzschraube Tellerkopf 8,0 x 100	Item No.	900129
	UK	Dish-shaped head wood screw with cutting edge 8 x 100		
	F	vis à bois à tête plate avec encoche 8 x 100		
	I	Vite a testa svasata 8 x 100 per pannello truciolare		
	E	Tornillo para madera con cabeza plana y ranura de incisión 8 x 100		
	D	Tellerkopfschraube A2 6,0x120 / TX 30	Item No.	900127
	UK	Dish-shaped wood screw A2 6,0x120 / TX 30		
	F	Vis à bois à tête plate avec encoche A2 6,0x120 / TX30		
	I	Vite a testa svasata 6x120/TX30 per pannello truciolare		
	E	Tornillo para madera con cabeza plana y ranura de incisión 6,0x120/TX30		
	D	Holzschraube Tellerkopf 6 x 160	Item No.	900145
	UK	Dish-shaped head wood screw with cutting edge 6 x 160		
	F	vis à bois à tête plate avec encoche 6 x 160		
	I	Vite a testa svasata 6 x 160 per pannello truciolare		
	E	Tornillo para madera con cabeza plana y ranura de incisión 6 x 160		



- D** Holzschraube Tellerkopf 8,0 x 50
- UK** Dish-shaped head wood screw with cutting edge 8 x 50
- F** vis à bois à tête plate avec encoche 8 x 50
- I** Vite a testa svasata 8 x 50 per pannello truciolare
- E** Tornillo para madera con cabeza plana y ranura de incisión 8 x 50

Item No.  
900316



- D** Holzschraube Linsenkopf 5 x 30
- UK** Wood screw mushroom head 5 x 30
- F** Vis à bois tête lenticulaire 5 x 30
- I** Vite da legno testa tonda 5 x 30
- E** Tornillo madera con cabeza convexa 5 x 30

Item No.  
900050



1x	<div style="display: flex; flex-direction: column; gap: 5px;"> <div><span style="border: 1px solid black; padding: 2px;">D</span> Dachhaken</div> <div><span style="border: 1px solid black; padding: 2px;">UK</span> Roof hooks</div> <div><span style="border: 1px solid black; padding: 2px;">F</span> Crochet de toit</div> <div><span style="border: 1px solid black; padding: 2px;">I</span> Staffa</div> <div><span style="border: 1px solid black; padding: 2px;">E</span> Gancho de tejado</div> </div>	+	n	<div style="display: flex; flex-direction: column; gap: 5px;"> <div><span style="border: 1px solid black; padding: 2px;">D</span> Holzschraube</div> <div><span style="border: 1px solid black; padding: 2px;">UK</span> Wood screw</div> <div><span style="border: 1px solid black; padding: 2px;">F</span> Vis a bois</div> <div><span style="border: 1px solid black; padding: 2px;">I</span> Vite da legno</div> <div><span style="border: 1px solid black; padding: 2px;">E</span> Tornillo de madera</div> </div>
----	--	---	---	---

	900305	900013	900129	900127	900145	900050
420151	3x	–	–	2x	2x	–
420161	3x	–	–	2x	2x	–
920003	–	–	2x	–	–	–
420150	3x	–	–	2x	2x	–
420153	2x	–	–	2x	2x	–
420154	2x	–	–	2x	2x	–
420155	–	2x	–	–	–	–
420158	3x	–	–	2x	2x	–
420160	–	–	–	–	–	3x
420165	3x	–	–	–	–	–
420180	2x	–	–	–	–	–
420181	2x	–	–	–	–	–
420182	2x	–	–	–	–	–
420183	2x	–	–	–	–	–



D Solarbefestiger für Stahlunterkonstruktion

UK Solar Fastener for steel substructure

F Élément de fixation solaire pour structures porteuses en acier

I Fissaggio solare per sottostruttura in acciaio

E Fijador solar para subconstrucción de acero

D Solarbefestiger für Holzunterkonstruktion

UK Solar fastener for wooden substructure

F Élément de fixation solaire pour structures porteuses en bois

I Fissaggio solare per sottostruttura in legno

E Fijador solar para subconstrucción de madera

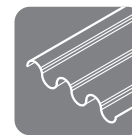
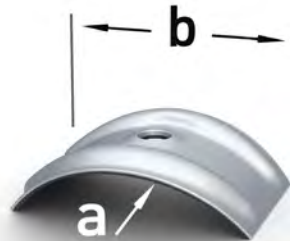
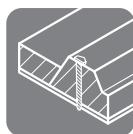
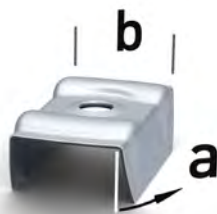
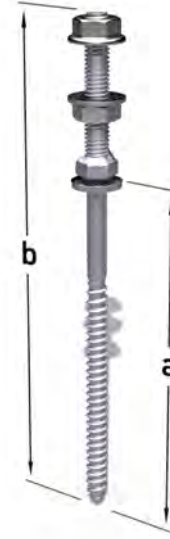
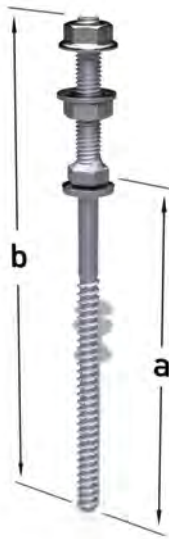



- D** Stockschraube
- UK** Hanger bolt
- F** Vis double filetage
- I** Vite prigioniera
- E** Tornillo espárrago de doble rosca

	Item No.	a (mm)	b (mm)	Ø
M10 x 200	860006	200	81	Ø9,0/M10
M12 x 250	860007	250	91	Ø11,0/M12
M12 x 300	860017	300	141	Ø11,0/M12
M12 x 350	920136	350	191	Ø11,0/M12
M12 x 400	920137	400	211	Ø11,0/M12



- D** Stockschraube (Anbindung versetzt)
- UK** Hanger bolt (offset connection)
- F** Vis double filetage (fixation décentrée)
- I** Vite prigioniera M10 x 160 (fissaggio decentrato)
- E** Tornillo espárrago de doble rosca (orificio dec.)

	Item No.	a (mm)	b (mm)	Ø
M10x160	920159	160	71	Ø9,0/M10
M10x200	920008	200	81	Ø9,0/M10
M12x250	920002	250	91	Ø11,0/M12



- D** Solarbefestiger für Stahlunterkonstruktion
- UK** Solar Fastener for steel substructure
- F** Fixation d'équip. solaire p. structure acier
- I** Fissaggio solare per sottostrutture acciaio
- E** Fijador para subestructuras metálicas

	Item No.	a (mm)	b (mm)	Ø
80/50	900181	80	136	Ø8,0/M10
100/50	900182	100	156	Ø8,0/M10
125/50	900183	125	181	Ø8,0/M10
150/50	900184	150	206	Ø8,0/M10
160/50	900185	160	216	Ø8,0/M10
200/50	900186	200	256	Ø8,0/M10



- D** Solarbefestiger für Holzunterkonstruktion
- UK** Solar Fastener for wooden substructure
- F** Fixation d'équip. solaire p. structure de bois
- I** Fissaggio solare per sottostrutture legna
- E** Fijador para subestructuras de madera

	Item No.	a (mm)	b (mm)	Ø
80/50	900187	80	136	Ø8,4/M10
100/50	900188	100	156	Ø8,4/M10
130/50	900189	130	186	Ø8,4/M10
150/50	900190	150	206	Ø8,4/M10
180/50	900191	180	236	Ø8,4/M10
200/50	900192	200	256	Ø8,4/M10



- D** Kalotte für Trapezblech
- UK** Storm washer for trapezoidal sheet
- F** Calotte pour toitures en tôles à ondes trapézoïdales
- I** Calotta per tetti a lamiera grecata
- E** Calota para tejados de chapa trapezoidal

	Item No.	a (mm)	b (mm)
W15/20	900205	15°	20
W15/25	900206	15°	25
W17/40	900207	17°	40
W22/57	900208	22°	57
W24/30	900209	24°	30
W27/25	900210	27°	25
W30/23	900211	30°	23
W32/54	900212	32°	54
W33/37	900213	33°	57
W35/20	900214	35°	20
W35/28	900215	35°	28
W36/40	900216	36°	40
W38/30	900217	38°	30
W40/26	900218	40°	26
W23/34	900219	23°	34



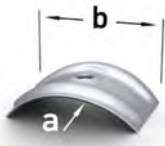

- D** Kalotte für Wellblech
- UK** Storm washer for corrugated sheet
- F** Calotte pour profilés ondulés
- I** Calotta per profilati ondulati
- E** Calota para perfiles ondulados

	Item No.	a (mm)	b (mm)
R24/40	900220	24	40
R32/51	900221	32	51
R48/57	900222	48	57



- D** Schirmdichtung für Solarbefestiger
- UK** EPDM gasket
- F** Joint
- I** Guarnizione
- E** Junta de apantallamiento

Item No.	Qty.
900193	

	a (mm)	b (mm)
EPDM	8,4	25



- D** Solarbefestigerblech für Bitumenschindel 246x205 mm
- UK** Solar fastener flashing for bitumen shingles 246x205 mm
- F** Tôle de élément de fixation solaire pour bardeaux bitumeux 246x205
- I** Latta per fissaggio solare per tegola bituminosa 246x205
- E** Chapa para fijador solar en placas bituminosas 246x205

Item No.
900203

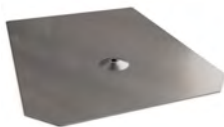

- D** Solarbefestigerblech für Bitumenschindel 380x280 mm
- UK** Solar fastener flashing for bitumen shingles 380x280 mm
- F** Tôle de élément de fixation solaire pour bardeaux bitumeux 380x280
- I** Latta per fissaggio solare per tegola bituminosa 380x280
- E** Chapa para fijador solar en placas bituminosas 380x280

Item No.
900204



	D	TS+ Schere (SET)	Item No.	420550
	UK	TS+ V-frame (SET)		
	F	TS+ Support en ciseaux (SET)		
	I	TS+ Staffa a forbice (SET)		
	E	TS+ Perfil articulado (SET)		

	D	TS+ Stütze		
	UK	TS+ Support		
	F	TS+ Colonne		
	I	TS+ Puntello		
	E	TS+ Soporte		

	Item No.	Aufständigungswinkel/Angle of elevation
10°	400552	10°
15°	400553	15°
20°	400554	20°
25°	400555	25°
30°	400556	30°
35°	400557	35°

	D	TS+ Dreieck (montiert)		
	UK	TS+ Triangle (assembled)		
	F	TS+ Triangle (monté)		
	I	TS+ Triangolo (montata)		
	E	TS+ Triángulo (montado)		

	Item No.	Aufständigungswinkel/Angle of elevation
10°	410552	10°
15°	410553	15°
20°	410554	20°
25°	410555	25°
30°	410556	30°
35°	410557	35°

	D	TS+ L-Profil Querverstrebung (SET)	Item No.	420600
	UK	TS+ L-Profile cross striving profile (SET)		
	F	TS+ Renfort L-profilé croisé complet(SET)		
	I	TS+ L-Profili controvento completi (SET)		
	E	TS+ L-profil esfuerzo (SET)		

	D	TS+ L-Profil Querverstrebung 1900mm (SET)	Item No.	420601
	UK	TS+ L-Profile cross striving profile 1900mm(SET)		
	F	TS+ Renfort L-profilé croisé complet 1900mm(SET)		
	I	TS+ L-Profili controvento completi 1900mm (SET)		
	E	TS+ L-profil esfuerzo 1900mm(SET)		



- D** VS+ Montageschiene 41x35
- UK** VS+ Mounting rail 41x35
- F** VarioSole+ Profilé de montage 41x35
- I** VarioSole+ Guida alluminio 41x35
- E** VarioSole+ Perfil base 41x35

Item No.	Länge/Length	Farbe/Colour
400523-Z	2225	Blank/Blank
400523-B	2250	Schwarz/Black
400524-Z	3300	Blank/Blank
400524-B	3300	Schwarz/Black
400525-Z	4400	Blank/Blank
400525-B	4400	Schwarz/Black
400513	6200	Blank/Blank
400519	Zuschnitt/Custom cut	Blank/Blank
400519-B	Zuschnitt/Custom cut	Schwarz/Black



- D** VS+ Montageschiene 50x37
- UK** VS+ Mounting rail 50x37
- F** VarioSole+ Profilé de montage 50x37
- I** VarioSole+ Guida alluminio 50x37
- E** VarioSole+ Perfil base 50x37





Item No.	Länge/Length	Farbe/Colour
400527	2250	Blank/Blank
400527-B	2250	Schwarz/Black
400528-Z	3300	Blank/Blank
400528-B	3300	Schwarz/Black
400529-Z	4400	Blank/Blank
400529-B	4400	Blank/Blank
400506	6200	Blank/Blank
400509	Zuschnitt/Custom cut	Blank/Blank
400509-B	Zuschnitt/Custom cut	Schwarz/Black





- D** VS+ Montageschiene 60 x 38 x 3300 mm
- UK** VS+ Mounting rail 60 x 38 x 3300 mm
- F** VS+ Profilé de montage 60 x 38 x 3300 mm
- I** VS+ Guida alluminio 60 x 38 x 3300 mm
- E** VS+ Perfil base 60 x 38 x 3300 mm

Item No.  
400535













	D VS+ Schienenverbinder 41 x 35	Item No. 400531
	UK VS+ Rail connector 41 x 35	
	F VS+ Raccord de profilés de montage 41 x 35	
	I VS+ Connettore per guida 41 x 35	
	E VS+ Carril de unión para perfil 41 x 35	
	D VS+ Schienenverbinder 50 x 37	Item No. 400532
	UK VS+ Rail connector 50 x 37	
	F VS+ Raccord de profilés de montage 50 x 37	
	I VS+ Connettore per guida 50 x 37	
	E VS+ Carril de unión para perfil 50 x 37	
	D VS+ Schienenverbinder 60 x 38	Item No. 400533
	UK VS+ Rail connector 60 x 38	
	F VS+ Raccord de profilés de montage 60 x 38	
	I VS+ Connettore per guida 60 x 38	
	E VS+ Carril de unión para perfil 60 x 38	
	D Abschlusskappe LINKS / RECHTS (grau ) 50x37	Item No. 920044
	UK End Cap RIGHT / LEFT (grey) 50x37	
	F Capuchon de rail DROITE / GAUCHE (gris) 50x37	
	I Tappo DESTRO / SINISTRO (grigio) 50x37	
	E Embellecedor lateral DERCHO / IZQUIERDO (gris) 50x37	
	D Abschlusskappe LINKS / RECHTS (schwarz ) 50x37	Item No. 920043
	UK End Cap RIGHT / LEFT (black) 50x37	
	F Capuchon de rail DROITE / GAUCHE (noir) 50x37	
	I Tappo DESTRO / SINISTRO (nero) 50x37	
	E Embellecedor lateral DERCHO / IZQUIERDO (negro) 50x37	
	D Abdeckkappe VS+ Montageschiene 41x35 grau	Item No. 900246
	UK Cap VS+ Mounting rail 41x35 (grey)	
	F Capuchon VS+ Profilé de montage 41x35 (gris)	
	I Tappo di copertura VS+ Guida alluminio 41x35 (grigio)	
	E Tapa de cobertura VS+ Perfil base 41x35 (gris)	
	D Abdeckkappe VS+ Montageschiene 41x35 (schwarz)	Item No. 900245
	UK Cap VS+ Mounting rail 41x35 (black)	
	F Capuchon VS+ Profilé de montage 41x35 (noir)	
	I Tappo di copertura VS+ Guida alluminio 41x35 (nero)	
	E Tapa de cobertura VS+ Perfil base 41x35 (negro)	



	D Kreuzschienenverbinder+	Item No. 420083
	UK Cross rail connector+	
	F Raccord perpendiculaire+	
	I Connettore perpendicolare+	
	E Carril de unión perpendicular+	
	D Kreuzschienenverbinder+ (schwarz)	Item No. 420083-BE
	UK Cross rail connector+ (black)	
	F Raccord perpendiculaire+ (noir)	
	I Connettore perpendicolare+ (nero)	
	E Carril de unión perpendicular+ (negro)	

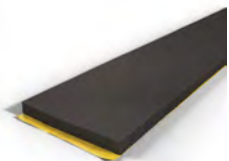
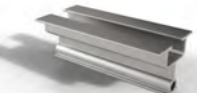



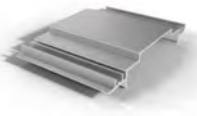

	D Bodenschiene FS10-S 1389 mm	Item No. 500400
	UK Base rail FS10-S 1389 mm	
	F Rail de montage FS10-S 1389 mm	
	I Guida di supporto FS10-S 1389 mm	
	E Perfil de montaje FS10-S 1389 mm	
	D Bodenschiene FS10-S 1639 mm	Item No. 500402
	UK Base rail FS10-S 1639 mm	
	F Rail de montage FS10-S 1639 mm	
	I Guida di supporto FS10-S 1639 mm	
	E Perfil de montaje FS10-S 1639 mm	
	D Bodenschiene FS18-S 1739 mm	Item No. 500401
	UK Base rail FS18-S 1739 mm	
	F Rail de montage FS18-S 1739 mm	
	I Guida di supporto FS18-S 1739 mm	
	E Perfil de montaje FS18-S 1739 mm	
	D Bodenschiene FS18-S 1989 mm	Item No. 500403
	UK Base rail FS18-S 1989 mm	
	F Rail de montage FS18-S 1989 mm	
	I Guida di supporto FS18-S 1989 mm	
	E Perfil de montaje FS18-S 1989 mm	
	D Bodenschiene FS10-EW 1989 mm	Item No. 500501
	UK Base rail FS10-EW 1989 mm	
	F FS10-EW Rail de montage FS10-EW 1989 mm	
	I FS10-EW Guida di supporto FS10-EW 1989 mm	
	E FS10-EW Perfil de montaje FS10-EW 1989 mm	
	D Bodenschiene FS10-EW 2060 mm	Item No. 500407
	UK Base rail FS10-EW 2060mm	
	F Rail de montage FS10-EW 2060 mm	
	I Guida di supporto FS10-EW 2060 mm	
	E Perfil de montaje FS10-EW 2060 mm	
	D Bodenschiene FS10-EW 2260 mm	Item No. 500500
	UK Base rail FS10-EW 2260 mm	
	F Rail de montage FS10-EW 2260 mm	
	I Guida di supporto FS10-EW 2260 mm	
	E Perfil de montaje FS10-EW 2260 mm	

	D	Bautenschutzmatte 110x95x20mm standard	Item No. 500410
	UK	Roof protection pad 110x95x20mm standard	
	F	Tapis de protection 110x95x20 mm standard	
	I	Stuoia di protezione 110x95x20mm standard	
	E	Protección para la cubierta 110x95x20mm estándar	
	D	Bautenschutzmatte 110x95x20mm alu kaschiert	Item No. 500411
	UK	Roof protection pad 110x95x20mm alu coated	
	F	Tapis de protection 110x95x20 mm revêtement alu	
	I	Stuoia di protezione 110x95x20mm effetto alluminio	
	E	Protección para la cubierta 110x95x20mm forrada de aluminio	
	D	Bautenschutzmatte 1000x100x11 mm für Bodenschiene	Item No. 500412
	UK	Roof protection pad 1000x100x11 mm for base rail	
	F	Tapis de protection 1000x100x11 mm pour rail de montage	
	I	Stuoia di protezione 1000x100x11 mm par guida di supporto	
	E	Protección para la cubierta 1000x100x11 mm para perfil de montaje	
	D	Auflager Traufe	Item No. 500420
	UK	Eave support	
	F	Support de gouttière	
	I	Supporto grondaia	
	E	Soporte canalón	
	D	Auflager First 10°	Item No. 500421
	UK	Ridge support 10°	
	F	Support de faîte 10°	
	I	Supporto colmo 10°	
	E	Soporte cumbrera 10°	
	D	Auflager First 18° (montiert)	Item No. 510422
	UK	Ridge support 18° (assembled)	
	F	Support de faîte 18° (monté)	
	I	Supporto colmo 18° (montata)	
	E	Soporte cumbrera 18° (montado)	
	D	FS10-EW Auflager First 10°	Item No. 500520
	UK	FS10-EW Ridge support 10°	
	F	FS10-EW Support de faîte 10°	
	I	FS10-EW Supporto colmo 10°	
	E	FS10-EW Soporte cumbrera 10°	
	D	Bodenschiennenverbinder	Item No. 500404
	UK	Base rail connector	
	F	Raccord pour rails	
	I	Raccordo per guide	
	E	Unión para perfiles de montaje	



	<b>D</b> Streamliner FS10-S 1800 mm	<b>Item No.</b> 500450
	<b>UK</b> Streamliner FS10-S 1800 mm	
	<b>F</b> Streamliner FS10-S 1800 mm	
	<b>I</b> Streamliner FS10-S 1800 mm	
	<b>E</b> Streamliner FS10-S 1800 mm	
	<b>D</b> Streamliner FS10-S 2150 mm	<b>Item No.</b> 500453
	<b>UK</b> Streamliner FS10-S 2150 mm	
	<b>F</b> Streamliner FS10-S 2150 mm	
	<b>I</b> Streamliner FS10-S 2150 mm	
	<b>E</b> Streamliner FS10-S 2150 mm	
	<b>D</b> Streamliner FS18-S 1800 mm	<b>Item No.</b> 500454
	<b>UK</b> Streamliner FS18-S 1800 mm	
	<b>F</b> Streamliner FS18-S 1800 mm	
	<b>I</b> Streamliner FS18-S 1800 mm	
	<b>E</b> Streamliner FS18-S 1800 mm	
	<b>D</b> Streamliner FS18-S 2150 mm	<b>Item No.</b> 500455
	<b>UK</b> Streamliner FS18-S 2150 mm	
	<b>F</b> Streamliner FS18-S 2150 mm	
	<b>I</b> Streamliner FS18-S 2150 mm	
	<b>E</b> Streamliner FS18-S 2150 mm	
	<b>D</b> Steckbolzen 6x110 mm	<b>Item No.</b> 900314
	<b>UK</b> Socket bolt 6 x 110 mm	
	<b>F</b> Axe débrochable 6 x 110 mm	
	<b>I</b> Vite cilindrica a scatto rapido 6x110	
	<b>E</b> Perno Enchufable 6x110	
	<b>D</b> Bohrschraube 4,8x19 A2	<b>Item No.</b> 900229
	<b>UK</b> Self Drilling Screw 4,8x19 A2	
	<b>F</b> Vis autoforeuse 4,8x19 A2	
	<b>I</b> Vite autoperforante 4,8x19 A2	
	<b>E</b> Tornillo autoperforante 4,8x19 A2	



	D Bohrschraube 5,5x35 A2	Item No. 900234
	UK Self Drilling Screw 5,5x35 A2	
	F Vis autoforeuse 5,5x35 A2	
	I Vite auto perforante 5,5x35 A2	
	E Tornillo auto perforante 5,5x35 A2	
	D U-Scheibe DIN9021-6,4-A2	Item No. 900028
	UK Plain washer DIN9021-6,4-A2	
	F Rondelle DIN9021-6,4-A2	
	I Rondella DIN9021-6,4-A2	
	E Arandela DIN9021-6,4-A2	
	D ECO Ballastset FS	Item No. 520501
	UK ECO Ballast set FS	
	F ECO Set de remplissage FS	
	I ECO Set di ballast per FS	
	E ECO Juego por lastre para FS	
	D ECO Ballastset FS 2100 mm	Item No. 520502
	UK ECO Ballast set FS 2100 mm	
	F ECO Set de remplissage FS 2100 mm	
	I ECO Set di ballast per FS 2100 mm	
	E ECO Juego por lastre para FS 2100 mm	
	D Potentialausgleichsset FS-S (SET)	Item No. 920249
	UK Potential equalisation FS-S (SET)	
	F Set de mise à la terre FS-S (SET)	
	I Set collegamento equipotenziale FS-S (SET)	
	E Set para cable de tierra FS-S (SET)	

# CS+ ballasted PV-Mounting System

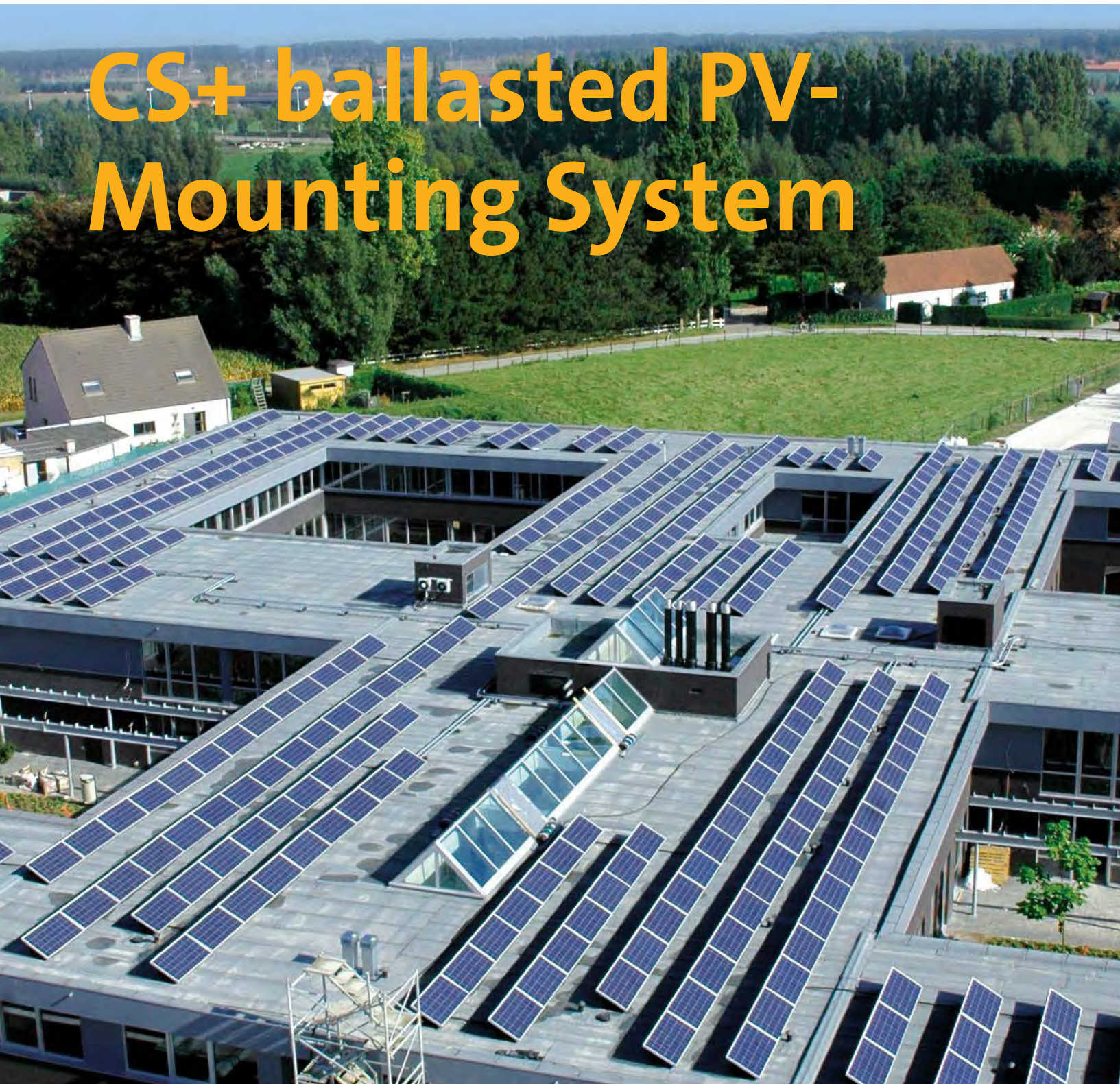

CS+







	D ConSole+ (inkl. Montagematerial und U-Profile)	Item No. 520075-K
	UK ConSole+ (incl. Mounting material and U-Profile)	
	F ConSole+ (incl. Material de montage e U-Profilé)	
	I ConSole+ (incl. Materiale di montaggio e U-Profilato)	
	E ConSole+ (incl. Material de montaje y U-perfil)	
	D Streamliner+	Item No. 520076
	UK Streamliner+	
	F Streamliner+	
	I Streamliner+	
	E Streamliner+	
	D Verlängerungsschienen für ConSole 4.1, 4.2, 5.2, 6.2	Item No. 460001
	UK Elongation rails for ConSole 4.1, 4.2, 5.2, 6.2	
	F Rails de rallonge pour ConSole 4.1, 4.2, 5.2, 6.2	
	I Set di prolunga per ConSole 4.1, 4.2, 5.2, 6.2	
	E Prolongación para ConSole 4.1, 4.2, 5.2, 6.2	
	D Montagematerial für ConSole 4.1, 4.2, 5.2, 6.2, CS+	Item No. 420022
	UK Mounting material for ConSole 4.1, 4.2, 5.2, 6.2, CS+	
	F Material de montage pour ConSole 4.1, 4.2, 5.2, 6.2, CS+	
	I Materiale di montaggio per ConSole 4.1, 4.2, 5.2, 6.2, CS+	
	E Material de montaje para ConSole 4.1, 4.2, 5.2, 6.2, CS+	
	D ConSole Clip	Item No. 920106
	UK ConSole Clip	
	F ConSole Clip	
	I ConSole Clip	
	E ConSole Clip	
	D Aluminium U-Profil 1035 mm ConSole 4.2, 5.2,6.2, CS+	Item No. 400005
	UK Aluminium U-Profile 1035 mm ConSole 4.2, 5.2,6.2, CS+	
	F Aluminium U-Profilé 1035 mm ConSole 4.2, 5.2,6.2, CS+	
	I Alluminio U-Profilato 1035 mm ConSole 4.2, 5.2,6.2, CS+	
	E Aluminio U-Perfil 1035 mm ConSole 4.2, 5.2,6.2, CS+	
	D Hintergriffklemme für CS+	Item No. 420023
	UK Rear grip clamp for CS+	
	F Pince de préhension arrière pour CS+	
	I Morsetto posteriore per CS+	
	E Pinza de agarre trasera para CS+	

# Roof Integrated



**ISSE**

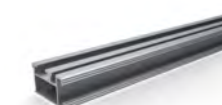

	D	Platte 1100 x 1600 mm	Item No.	500007
	UK	Plate 1100 x 1600 mm		
	F	Plaque 1100 x 1600 mm		
	I	Pannello 1100 x 1600 mm		
	E	Plancha 1100 x 1600 mm		
	D	InterSole Anker	Item No.	860004
	UK	InterSole Anchor		
	F	InterSole Ancre		
	I	InterSole Ancoraggio		
	E	InterSole Gancho		
	D	Winkel Standard	Item No.	860010
	UK	Bracket Standard		
	F	Equerre standard		
	I	Squadretta Standard		
	E	Escuadra de montaje estándar		
	D	Winkel Low	Item No.	860011
	UK	Bracket Low		
	F	Equerre basse		
	I	Squadretta Low		
	E	Escuadra de montaje baja		
	D	Montageschiene 3000 mm	Item No.	400018
	UK	Mounting rail 3000 mm		
	F	Profilé de montage 3000 mm		
	I	InterSole Guida in alluminio 3000 mm		
	E	InterSole Perfil 3000 mm		
	D	Montageschiene Zuschnitt/m	Item No.	460018
	UK	Mounting Rail custom cut /m		
	F	Profilé de montage coupe/m		
	I	InterSole Guida in alluminio su misura /m		
	E	Intersole Perfil a medida /m		
	D	InterSole Schienenverbinder	Item No.	400025
	UK	InterSole Rail connector		
	F	InterSole Raccord de profilés de montage		
	I	InterSole Connettore per guida		
	E	InterSole Carril de unión		
	D	InterSole Anschlussblech UNTEN	Item No.	700002
	UK	InterSole Gutter LOWER		
	F	InterSole Esthétivette INFÉRIEURE		
	I	InterSole Scossalina INFERIORE		
	E	InterSole Chapa de protección INFERIOR		



	D InterSole Anschlussblech UNTEN (schwarz)	Item No. 700002-B
	UK InterSole Gutter LOWER (black)	
	F InterSole Esthétivette INFÉRIEURE (noire)	
	I InterSole Scossalina INFÉRIORE (nera)	
	E InterSole Chapa de protección INFERIOR (negro)	
	D InterSole Anschlussblech SEITLICH	Item No. 700001
	UK InterSole Gutter SIDE	
	F InterSole Esthétivette LATÉRALE	
	I InterSole Scossalina LATÉRALE	
	E InterSole Chapa de protección LATERAL	
	D InterSole Anschlussblech SEITLICH (schwarz)	Item No. 700001-B
	UK InterSole Gutter SIDE (black)	
	F InterSole Esthétivette LATÉRALE (noire)	
	I InterSole Scossalina LATÉRALE (nera)	
	E InterSole Chapa de protección LATERAL (negro)	
	D InterSole Anschlussblech SEITLICH Flachziegel	Item No. 700103
	UK InterSole Gutter SIDE flat tiles	
	F Tôle de raccordement InterSole LATÉRALE tuiles plates	
	I Lamiera di giunzione LATÉRALE Intersole per tegole piane	
	E Intersole chapa de unión teja plana LATERAL	
	D InterSole Anschlussblech SEITLICH Flachziegel (schwarz)	Item No. 700103-B
	UK InterSole Gutter SIDE flat tiles (black)	
	F Tôle de raccordement InterSole LATÉRALE tuiles plates (noir)	
	I Lamiera di giunzione LATÉRALE Intersole per tegole piane (nera)	
	E Intersole chapa de unión teja plana LATERAL (negro)	
	D InterSole Anschlussblech OBEN	Item No. 700003
	UK InterSole Gutter UPPER	
	F InterSole Esthétivette SUPÉRIEURE	
	I InterSole Scossalina SUPÉRIORE	
	E InterSole Chapa de protección SUPERIOR	
	D InterSole Anschlussblech OBEN (schwarz)	Item No. 700003-B
	UK InterSole Gutter UPPER (black)	
	F InterSole Esthétivette SUPÉRIEURE (noire)	
	I InterSole Scossalina SUPÉRIORE (nera)	
	E InterSole Chapa de protección SUPERIOR (negro)	
	D Kompriband 20 x 4000 mm	Item No. 300100
	UK Sealing tape MPA 20 x 4000 mm	
	F Bande compressible 20 x 4000 mm	
	I Bandella di compressione 20 x 4000 mm	
	E Cinta de dilatación 20 x 4000 mm	



	D Kleber für wasserfeste Schürze 290 ml	Item No.	
	UK Sealing strip Glue 290 ml	300000	
	F Adhésif pour tablier de protection 290 ml		
	I Colla per membrana impermeabile 290 ml		
	E Adesivo faldon de estanqueidad 290 ml		
	D Hafte	Item No.	
	UK Mounting clip	720011	
	F Griffe		
	I Graffetta per scossaline		
	E Enganche		
	D Spenglerschraube 4,5 x 45	Item No.	
	UK Screw neoprene washer 4,5 x 45	900011	
	F Vis autoforeuse 4,5 x 45		
	I Vite autoforante con rondella in neoprene 4,5 x 45		
	E Tornillo de rosca autocortante con arandela 4,5 x 45		
	D Holzschraube Senkkopf 4,5 x 50	Item No.	
	UK Wood screw countersunk 4,5 x 50	900021	
	F Vis à bois avec tête fraisée 4,5 x 50		
	I Vite da legno testa piana 4,5 x 50		
	E Tornillo madera cabeza avellanada 4,5 x 50		
	D Servicepauschale InterSole Zeichnung	Item No.	
	UK Service for InterSole layout	200007	
	F Forfait de service de InterSole schémas		
	I Forfait de servizio InterSole disegno		
	E Servicio InterSole dibujo		
	D Wasserfeste Schürze 400 x 6000 mm	Item No.	
	UK Sealing strip 400 x 6000 mm	300002	Schwarz/Black
	F Tablier de protection 400 x 6000 mm	300003	Rot/Red
	I Membrana impermeabile 400 x 6000 mm		
	E Faldon de estanqueidad 400 x 6000 mm		
	D Wasserfeste Schürze 400 x 12000 mm	Item No.	
	UK Sealing strip 400 x 12000 mm	300004	Schwarz/Black
	F Tablier de protection 400 x 12000 mm	300005	Rot/Red
	I Membrana impermeabile 400 x 12000 mm		
	E Faldon de estanqueidad 400 x 12000 mm		
	D Wasserfeste Schürze 500 x 6000 mm	Item No.	
	UK Sealing strip 500 x 6000 mm	300006	Schwarz/Black
	F Tablier de protection 500 x 6000 mm	300009	Rot/Red
	I Membrana impermeabile 500 x 6000 mm		
	E Faldon de estanqueidad 500 x 6000 mm		

# ONE FOR ALL!











**RS1**









EINGEGANGEN 05. Sep. 2011		Einheit: mm	Material: 11	Gewicht:	Material:
		Skizze: de	420080		
		Datum: 05.09.11	RS1		
 Renusol Solar Mounting Systems Renusol GmbH Pilsenerstraße 2 61005 Köln				1	AL







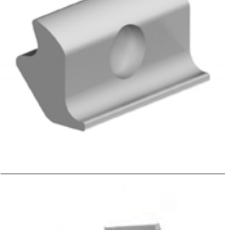



	D RS1	Item No. 420080
	UK RS1	
	F RS1	
	I RS1	
	E RS1	
	D RS1 (schwarz)	Item No. 420080-BE
	UK RS1 (black)	
	F RS1 (noire)	
	I RS1 (nero)	
	E RS1 (negro)	
	D Endklemme+	Item No. 420081
	UK End clamp+	
	F Bride simple+	
	I Morsetto terminale+	
	E Fijador lateral+	
	D Endklemme+ (schwarz)	Item No. 420081-BE
	UK End clamp+ (black)	
	F Bride simple+ (noire)	
	I Morsetto terminale+ (nero)	
	E Fijador lateral+ (negro)	
	D Mittelklemme+	Item No. 420082
	UK Middle clamp+	
	F Bride double+	
	I Morsetto intermedio+	
	E Fijador intermedio+	
	D Mittelklemme+ (schwarz)	Item No. 420082-BE
	UK Middle clamp+ (black)	
	F Bride double+ (noire)	
	I Morsetto intermedio+ (nero)	
	E Fijador intermedio+ (negro)	
	D P-Clip Potentialausgleich	Item No. 900268
	UK P-Clip Potential equalization	
	F P-Clip mise à la terre	
	I P-Clip collegamento equipotenziale	
	E P-Clip conexión equipotencial	
	D S-5! Stehfalzklemme E-Mini	Item No. 420254
	UK S-5! Clamp for standing seam E-Mini	
	F S-5! Bride pour couverture à joint debout E-Mini	
	I S-5! Lamiera graffata E-Mini	
	E S-5! Fijador E-Mini	



	D S-5! Stehfalzklemme Z-Mini	Item No. 420255
	UK S-5! Clamp for standing seam Z-Mini	
	F S-5! Bride pour couverture à joint debout Z-Mini	
	I S-5! Lamiera graffata Z-Mini	
	E S-5! Fijador Z-Mini	
	D S-5! Stehfalzklemme S-Mini	Item No. 420259
	UK S-5! Clamp for standing seam S-Mini	
	F S-5! Bride pour couverture à joint debout S-Mini	
	I S-5! Lamiera graffata S-Mini	
	E S-5! Fijador S-Mini	
	D S-5! Stehfalzklemme R-465	Item No. 400252
	UK S-5! Clamp for standing seam R-465	
	F S-5! Bride pour couverture à joint debout R-465	
	I S-5! Lamiera graffata R-465	
	E S-5! Fijador R-465	
	D S-5! Stehfalzklemme A-Mini	Item No. 400289
	UK S-5! Clamp for standing seam A-Mini	
	F S-5! Bride pour couverture à joint debout A-Mini	
	I S-5! Lamiera graffata A-Mini	
	E S-5! Fijador A-Mini	
	D S-5!® Stehfalzklemme K-Grip Mini	Item No. 420284
	UK S-5!® Clamp for standing seam K-Grip Mini	
	F S-5!® Bride pour couverture à joint debout K-Grip Mini	
	I S-5!® Lamiera graffata K-Grip Mini	
	E S-5!® Fijador K-Grip Mini	
	D S-5!® Einsatz für Stehfalzklemme K-Grip Mini (GXM10)	Item No. 400288
	UK S-5!® insert for Clamp for standing seam K-Grip Mini (GXM10)	
	F S-5!® Bride pour couverture à joint debout K-Grip Mini (GXM10)	
	I S-5!® Lamiera graffata K-Grip Mini (GXM10)	
	E S-5!® Fijador K-Grip Mini (GXM10)	
	D S-5!® Einsatz für Stehfalzklemme K-Grip Mini (GXM50)	Item No. 400285
	UK S-5!® insert for Clamp for standing seam K-Grip Mini (GXM50)	
	F S-5!® Bride pour couverture à joint debout K-Grip Mini (GXM50)	
	I S-5!® Lamiera graffata K-Grip Mini (GXM50)	
	E S-5!® Fijador K-Grip Mini (GXM50)	
	D Rib-Roof Stehfalzklemme 465	Item No. 400257
	UK Rib-Roof clamp for standing seam R-465	
	F Rib-Roof bride pour couverture à joint debout R-465	
	I Rib-Roof lamiera graffata R-465	
	E Rib-Roof fijador para junta alzada R-465	



	D Rib-Roof Stehfalzklemme 500	Item No. 400258	Price on request
	UK Rib-Roof clamp for standing seam R-500		Price on request
	F Rib-Roof bride pour couverture à joint debout R-500		Price on request
	I Rib-Roof lamiera graffata R-500		
	E Rib-Roof fijador para junta alzada R-500		
	D Rundfalzklemme für Kalzip und ähnliche	Item No. 400362	
	UK Round seam clamp for Kalzip and similar		
	F Pince pour joints debouts à tête ronde pour Kalzip et similaires		
	I Morsetto per lamiera graffata stondata Kalzip e simili		
	E Abrazadera de pliegue redonda para Kalzip y similares		
	D Stehfalzklemme KL+	Item No. 400602	
	UK Clamp for standing seam KL+		
	F Bride pour couverture à joint debout KL+		
	I Lamiera graffata KL+		
	E Fijador KL+		
	D LC1 Endklemme	Item No. 420084	
	UK LC1 End clamp		
	F LC1 Bride simple		
	I LC1 Morsetto terminale		
	E LC1 Fijador lateral		
	D LC1 Endklemme schwarz	Item No. 420084-B	
	UK LC1 End clamp black		
	F LC1 Bride simple noire		
	I LC1 Morsetto terminale nero		
	E LC1 Fijador lateral negro		
	D LC1 Mittelklemme	Item No. 420085	
	UK LC1 Middle clamp		
	F LC1 Bride double		
	I LC1 Morsetto intermedio		
	E LC1 Fijador intermedio		
	D LC1 Mittelklemme schwarz	Item No. 420085-B	
	UK LC1 Middle clamp black		
	F LC1 Bride double noire		
	I LC1 Morsetto intermedio nero		
	E LC1 Fijador intermedio negro		



R465 - R400252

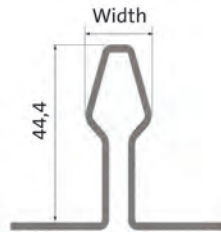

E-Mini - R420254

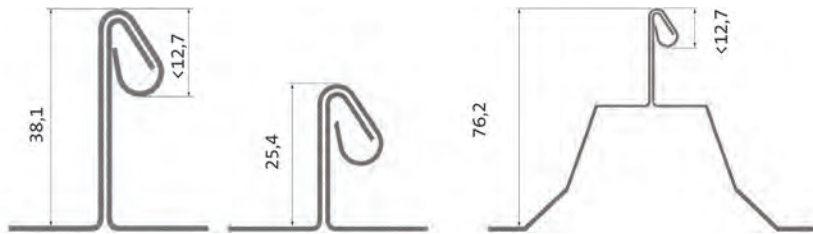

Z-Mini - R420255

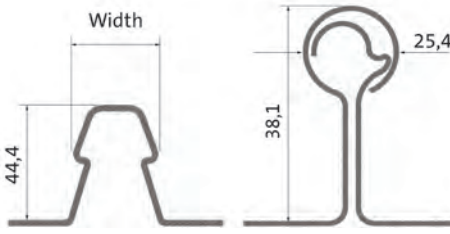

Rib-Roof 465 - R400257



Rib-Roof 500 - R400258

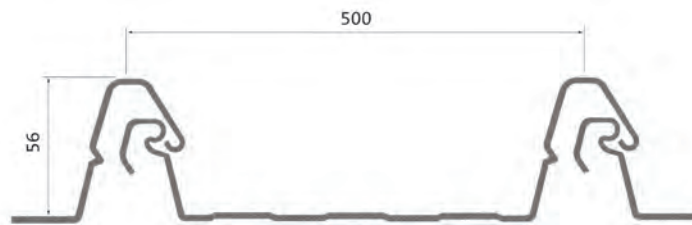

K-Grip-Mini - R420284 + GMX 10 - R400285

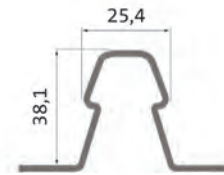

K-Grip-Mini - R420284 + GMX 50 - R400288

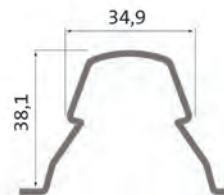
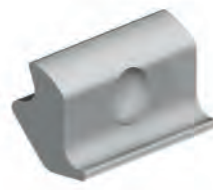



S-Mini - R420259

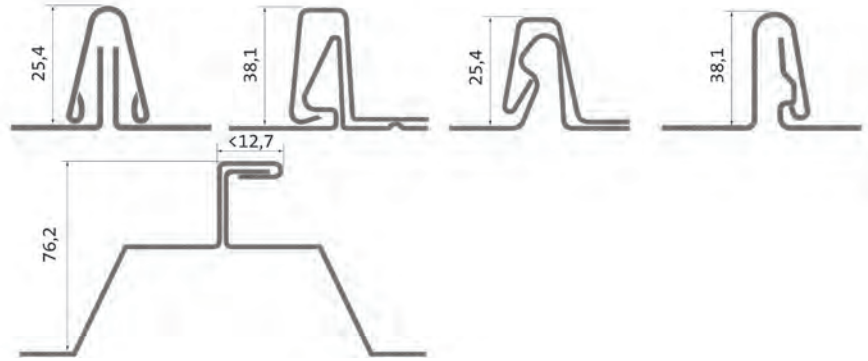
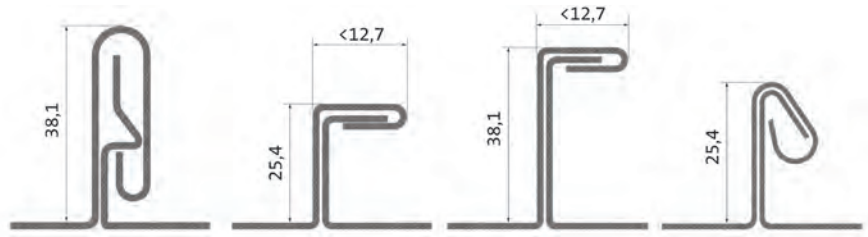

Kalzip and similar - R400362

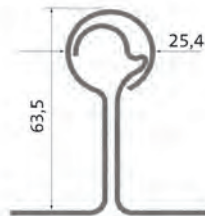



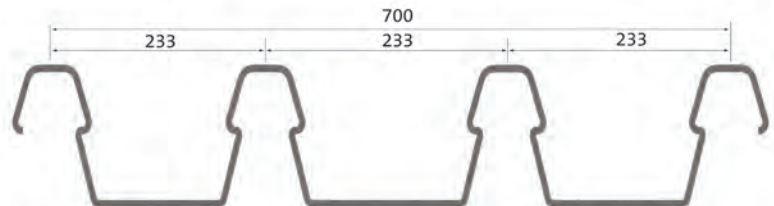





KL+ - R400602



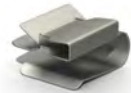









	D 6kt. Sperrzahnmutter mit Flansch M8	Item No. 900001
	UK Hexagon Nut w. serration M8	
	F Ecrou M8	
	I Dado flang. M8	
	E Tuerca dentada M8	
	D 6kt. Mutter ISO 4032 - M8 A2-70	Item No. 900036
	UK Hexagon nut ISO 4032 - M8 A2-70	
	F Ecrou ISO 4032 - M8 A2-70	
	I Dado esagonale ISO 4032-M8 A2-70	
	E Tuerca hexagonal ISO 4032 - M8 A2-70	
	D 6kt. Sicherheitsmutter M8	Item No. 900057
	UK Hexagon safety nut M8	
	F Écrou de sécurité M8	
	I Dado di sicurezza M8	
	E Tuerca de seguridad M8	
	D 6kt. Sperrzahnschraube M8 x 35 mit Flansch	Item No. 900025
	UK Hexag. bolt M8 x 35 with serration	
	F Vis tête hexagonale et embase crantée M8 x 35	
	I Vite flangiata M8 x 35 con sicura	
	E Tornillo M8 x 35 con corona autoblocante DIN 6921	
	D 6kt. Sperrzahnschraube M8 x 14 mit Flansch	Item No. 900016
	UK Hexag. Flange bolt with serration M8 x 14	
	F Vis tête hexagonale et embase crantée M8 x 14	
	I Vite flangiata con sicura M8 x 14	
	E Tornillo con bloqueo dentado con reborde M8 x 14	
	D Hammerkopfschraube M8 x 20	Item No. 900009
	UK Hammerhead bolt M8 x 20	
	F Vis tête marteau M8 x 20	
	I Vite testa a martello M8 x 20	
	E Tornillo con cabeza de martillo M8 x 20	
	D Hammerkopfschraube M8 x 25	Item No. 900007
	UK Hammerhead bolt M8 x 25	
	F Vis tête marteau M8 x 25	
	I Vite testa a martello M8 x 25	
	E Tornillo con cabeza de martillo M8 x 25	
	D 6kt. Schraube DIN931 u. Mutter DIN934	Item No. 900015
	UK Hexagon Bolt DIN931 and Hexagon Flange DIN934	
	F Vis tête hexagonale DIN931 avec écrou DIN 934	
	I Vite flangiata DIN931 e Dado flangiato DIN934	
	E Hexag. Bolt DIN931 y Tuerca DIN934	

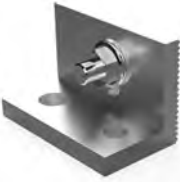

	D U-Scheibe M8	Item No. 900054
	UK Washer M8	
	F Rondelle M8	
	I Rondella M8	
	E Arandela M8	
	D Kabelclip 0,7-3mm mit Kabelbinder	Item No. 900035
	UK Edge Clip 0,7-3mm with cable strap	
	F Lanière assemblée pour bord de cadre 0,7-3 mm	
	I Clip di fissazione laterale 0,7-3 mm, con cavo	
	E Clip de fijación lateral 0,7-3 mm, con brida	
	D Kabelhalter 90°	Item No. 900260
	UK Wire clip 90°	
	F Porte-câble 90°	
	I Portacavo 90°	
	E Soporte de cables	
	D Kabelclip Omega	Item No. 900261
	UK Wire clip Omega	
	F Clip de fixation de câbles Omega	
	I Clip Omega	
	E Clip de cables Omega	
	D Diebstahlsicherung Flüssigmetall	Item No. 900230
	UK Anti theft liquid metal	
	F Protection antivol - Métal liquide	
	I Protezione antifurto - Metallo liquido	
	E Protección antirrobo - Metal líquido	
	D UNI-Falzklemme	Item No. 900240
	UK UNI- Frame L-foot clamp for grounding	
	F UNI-Bride de serrage	
	I UNI-Morsetto per coperture a giunto aggraffato	
	E UNI-Fijador para cubiertas plegadas	
	D UNI- Erdungsklemme	Item No. 900241
	UK UNI-Grounding clamp	
	F UNI-Borne de terre	
	I UNI-Morsetto di messa a terra	
	E UNI-Terminal de puesta a tierra	
	D Befestigungskit für SolarEdge Optimizer(SET)	Item No. 420271
	UK Attachment kit for SolarEdge optimizer (SET)	
	F Set de fixation pour Solaredge Optimizer	
	I Set di montaggio per ottimizzatore di potenza SolarEdge	
	E Juego de fijaci' n para SolarEdge Optimizer	



	D Winkel M10	Item No. 420014
	UK Bracket M10	
	F Equerre M10	
	I Squadretta M10	
	E Escuadra M10	
	D Winkel M12	Item No. 420012
	UK Bracket M12	
	F Equerre M12	
	I Squadretta M12	
	E Escuadra M12	
	D Winkel M10 (Anbindung versetzt)	Item No. 420131
	UK Bracket M10 (offset connection)	
	F Equerre M10 (fixation décentrée)	
	I Squadretta M10 (fissaggio decentrato)	
	E Escuadra M10 (orificio de fijación decentrado)	
	D Winkel M12 (Anbindung versetzt)	Item No. 420130
	UK Bracket M12 (offset connection)	
	F Equerre M12 (fixation décentrée)	
	I Squadretta M12 (fissaggio decentrato)	
	E Escuadra M12 (orificio de fijación decentrado)	
	D Winkel IFP M8/M10, Set(1st.)	Item No. 420024
	UK Bracket IFP M8/M10, set(1pc.)	
	F Équerre IFP M8/M10, SET(1pce.)	
	I Squadretta IFP M8/M10, SET(1pz.)	
	E Escuadra de montaje IFP M8/M10, JUEGO(1pz.)	
	D Winkel UK M8, (SET)	Item No. 420352
	UK UK M8 bracket, (SET)	
	F Équerre UK M8, (SET)	
	I Angolare UK M8, (SET)	
	E Escuadra UK M8, (SET)	
	D Microinverter Befestigungswinkel, Set	Item No. 400270
	UK Microinverter mounting bracket, Set	
	F Équerre de fixation micro-onduleur VS, set	
	I Piastra angolare per microinverter VS, set	
	E Microinversor escuadra de fijación, set	
	D Vorsatzgerät SFS DS-K 265 für Akkuschauber	Item No. 999900
	UK Attachment SFS DS-K 265 for cordless screwdriver	
	F Adaptateur SFS DS-K 265 pour visseuse électrique	
	I Adattatore SFS DS-K 265 per avvitatore a batteria	
	E Adaptator SFS DS-K 265 por atornilladora de acu	





- D** Montage-Bit mit Spannring 8mm

---

- UK** Assembly bit with clamping ring 8mm

---

- F** Embout de montage avec bague de serrage 8mm

---

- I** Punta di montaggio con anello di serraggio 8mm







---

- E** Punta de montaje con anillo de fijación 8mm

---

Item No.  
999940



	D RS1 Handmuster	Item No. 500108
	UK RS1 sample	
	F RS1 Echantillon	
	I RS1 Campionatura	
	E RS1 Muestra	
	D VS+ Handmuster	Item No. 500106
	UK VS+ sample	
	F VS+ Echantillon	
	I VS+ Campionatura	
	E VS+ Muestra	
	D MS+ Handmuster	Item No. 500107
	UK MS+ sample	
	F MS+ Echantillon	
	I MS+ Campionatura	
	E MS+ Muestra	
	D FS10-S Handmuster	Item No. 500109
	UK FS10-S sample	
	F FS10-S Echantillon	
	I FS10-S Campionatura	
	E FS10-S Muestra	
	D VS+ Systemmuster	Item No. 500065
	UK VS+ system sample	
	F VS+ Echantillon de système	
	I VS+ Campionatura sistema	
	E VS+ Muestra del sistema	
	D InterSole Handmuster	Item No. 500018
	UK InterSole SE sample	
	F InterSole SE Echantillon	
	I InterSole SE campionatura	
	E InterSole SE Muestra	
	D Display VS+/MS+	Item No. 500113
	UK Display VS+/MS+	
	F Affichage VS+ /MS+	
	I Display VS+/MS+	
	E IPantalla VS+ /MS+	

Renusol Europe GmbH  
Piccoloministrasse 2  
51063 Cologne  
Germany

Sales department  
Telephone: +49 221 788707-19  
Fax: +49 221 788707-97  
Email: sales-support@renusol.com

Telephone: +49 221 788707-0  
Fax: +49 221 788707-99  
Email: info@renusol.com  
www.renusol.com

Application technicians  
Telephone: +49 221 788707-29  
Fax: +49 221 788707-98  
Email: technical-support@renusol.com

DE | Abbildungen und Texte entsprechen dem aktuellen technischen Stand bei Drucklegung, Änderungen vorbehalten.

GB | The images and texts in these instructions relate to the latest technology at the time of printing, subject to modifications.

FR | Les illustrations et textes sont conformes à l'état de la technique au moment de mise sous presse. Sous toutes réserves de modifications.

IT | Figure e testi corrispondono allo stato più attuale della tecnica al momento dell'ordine di stampa. Con riserva di modifiche.

ES | Las imágenes y los textos se corresponden al estado actual de la técnica en el momento de la impresión, reservado el derecho a las modificaciones.

NL | Afbeeldingen en teksten voldoen aan de actuele stand van de techniek op het moment van ter perse gaan. Wijzigingen voorbehouden.

DK | Afbildninger og tekster overholder den tekniske stand ved trykningen, der tages forbehold for ændringer.

SE | Bilder och texter motsvarar den nuvarande tekniska tillstånd vid tidpunkten för tryckning, med förbehåll för ändringar.

CZ | Vyobrazení a texty odpovídají aktuálnímu technickému stavu při odevzdání do tisku. Změny vyhrazeny.

PL | Ilustracje i teksty odpowiadają stanowi techniki aktualnemu w chwili oddania instrukcji do druku. Zastrzega się prawo do zmian.

LT | Spausdinami paveikslėliai ir tekstas atitinka naujausią technikos lygį. Pasilieka me teisę į pakeitimus.

HU | Az ábrák és a szövegek a nyomtatás időpontjában rendelkezésünkre álló legfrissebb műszaki ismereteknek felelnek meg; a módosítások jogát fenntartjuk.

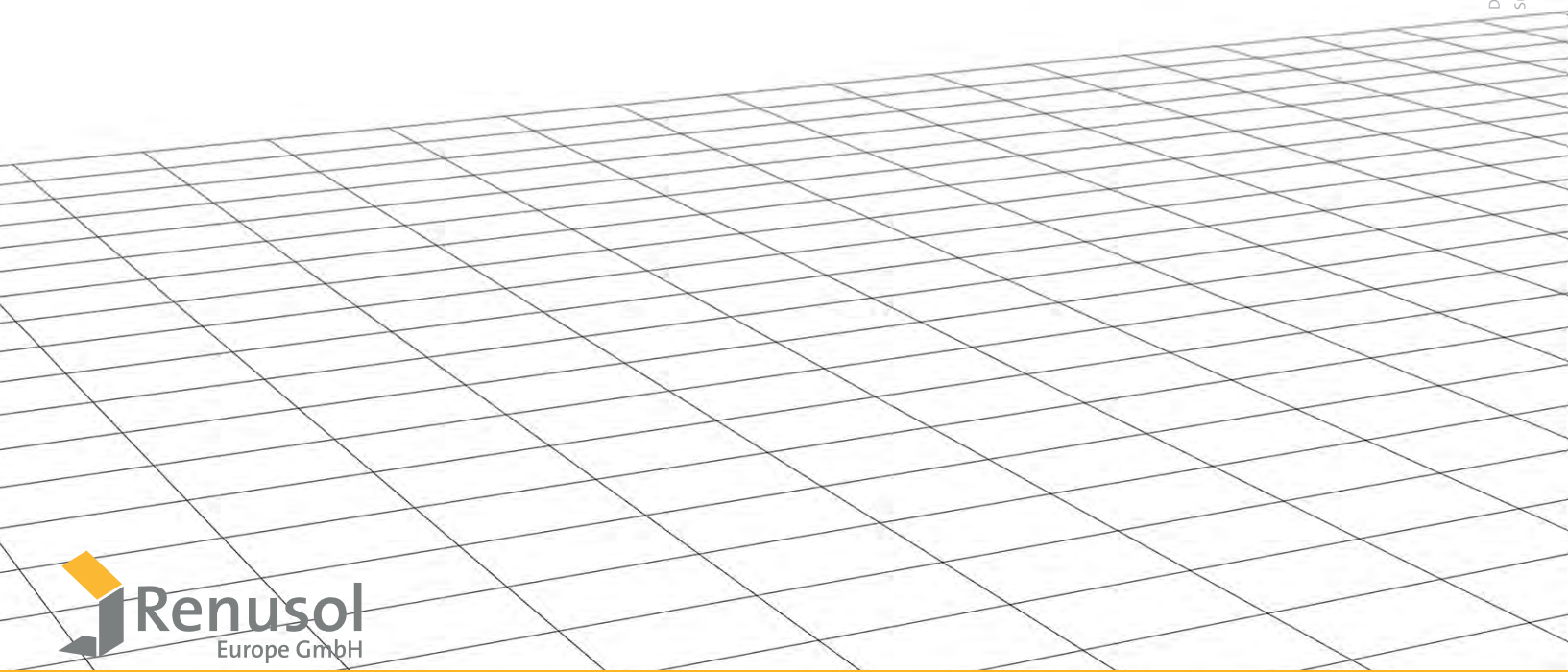

Renusol Europe GmbH

Piccoloministr. 2  
51063 Köln

+49 221 788707-0  
+49 221 788707-99

info@renusol.com  
www.renusol.com

Druckfehler und Irrtümer, technische oder sonstige Änderungen sowie Änderungen in der Verfügbarkeit einzelner Produkte sind ausdrücklich vorbehalten.  
Subject to misprints and errors, technical or other modifications, including changes to the range of products available are expressly reserved.