



**Pb Free Plating Product**

## FMG22S thru FMG24S

10.0 Ampere Dual Unipolar/Common Cathode Polarity Ultrafast Recovery Diode

### Features

- ★ Fast switching for high efficiency
- ★ Low forward voltage drop
- ★ High current capability
- ★ Low reverse leakage current
- ★ High surge current capability

### Application

- ★ Automotive Environment(Inverter/Converter)
- ★ Plating Power Supply,UPS and Adaptor
- ★ Car Audio Amplifier and Sound Device System

### Mechanical Data

- ★ Glass passivated chip junction
- ★ Case:TO-220F insulated package type
- ★ Epoxy: UL 94V-0 rate flame retardant
- ★ Terminals: Solderable per MIL-STD-202 method 208
- ★ Polarity: " S " " R " " U " type( As marked )
- ★ Mounting position: Any
- ★ Weight: 2.2 gram approximately

### ELECTRICAL CHARACTERISTICS

Parameter Type No.	Absolute Maximum Ratings					Electrical Characteristics (Ta=25°C)							Others		
	V <sub>RM</sub> (V)	I <sub>F(AV)</sub> (A) With Heatsink	I <sub>F(SM)</sub> (A) 50Hz Half-cycle Sinewave Single Shot	T <sub>J</sub> (°C)	T <sub>stg</sub> (°C)	V <sub>F</sub> (V) max per element	I <sub>R</sub> (mA) I <sub>F</sub> (A)	I <sub>R</sub> (H) (mA) V <sub>R</sub> =V <sub>RM</sub> max per element	I <sub>R</sub> (H) (mA) V <sub>R</sub> =V <sub>RM</sub> , Ta=100°C max per element	t <sub>rr</sub> (1) (ns)	t <sub>rr</sub> (2) (ns)	R <sub>th(j-c)</sub> (°C/W)	Mass (g)	Fig.	
FMG22S FMG-22S	200	10.0	65	-40 to +150		0.98	5.0	0.25	1.0	40	100/100	30	4.0	2.1	A
FMG23S FMG-23S	300		70			1.30		0.1	0.5	50		35			
FMG24S FMG-24S	400								0.2						

### External Dimensions

(Unit: mm) (Full-mold)

Flammability:  
UL94V-0 or Equivalent

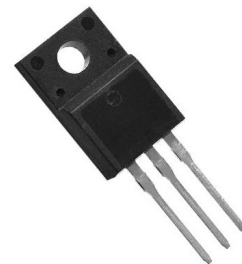
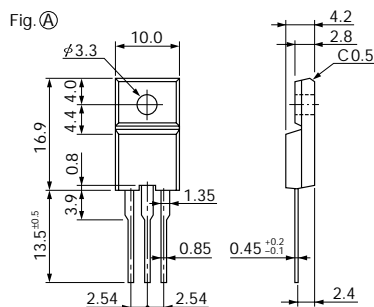

### Internal Configurations

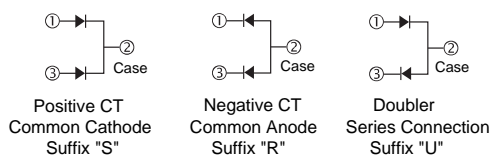

ITO-220AB/TO-220F/TO-220FH/TO-220FG/TO-220FB  
TO-220 Fully Isolated/Insulated Plastic Package Outline

## RATINGS AND CHARACTERISTIC CURVES (FMG22S thru FMG24S)

FMG22S/FMG22R/FMG22U

FMG-22S/FMG-22R/FMG-22U

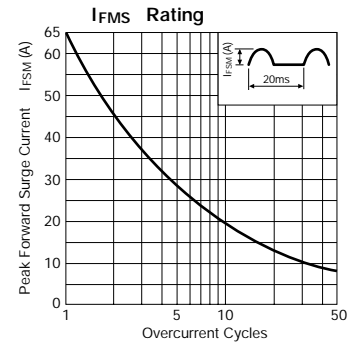
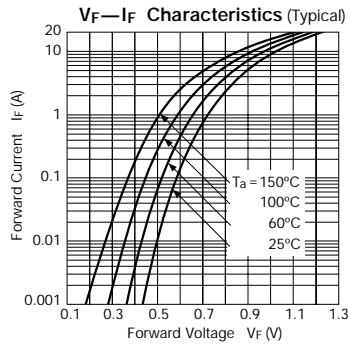
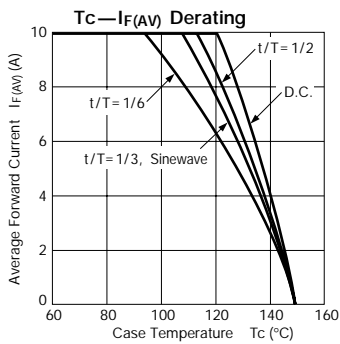

FMG23S/FMG23R/FMG23U

FMG-23S/FMG-23R/FMG-23U

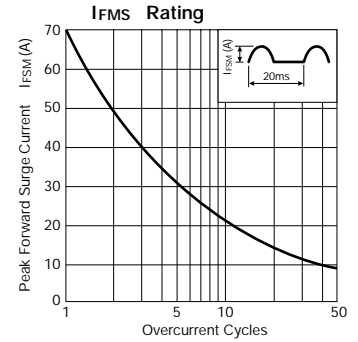
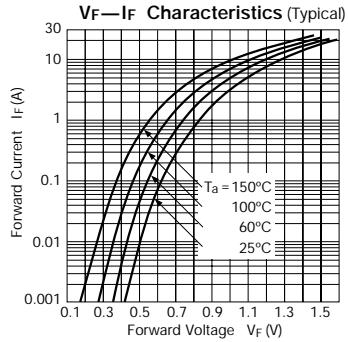
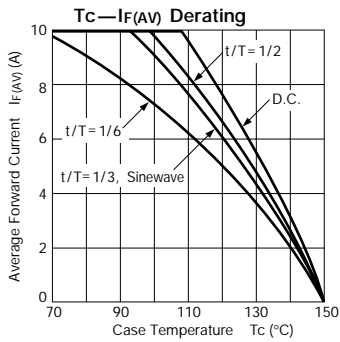

FMG24S/FMG24R/FMG24U

FMG-24S/FMG-24R/FMG-24U

