

USR-W610 User Manual

File Version: V1.0.1.01



Contents

USR-W610 User Manual.....	1
Features.....	4
1.Get Start.....	5
1.1.Application Diagram.....	5
1.2.Hardware.....	5
1.2.1.LED.....	5
1.2.2.Interface.....	6
1.2.3.Dimension.....	6
2.Networking application.....	7
2.1.Wireless networking.....	7
2.1.1.AP mode.....	7
2.1.2.STA mode.....	7
2.1.3.AP+STA mode.....	7
2.1.4.AP, STA application.....	8
2.1.5.Encryption mode.....	8
2.2.Wired networking.....	8
2.2.1.AP+LAN.....	8
2.2.2.AP+WAN.....	9
2.2.3.Route mode.....	9
2.2.4.Bridge mode.....	9
3.Product Functions.....	11
3.1.Work mode.....	11
3.1.1.Transparent transmission mode.....	11
3.1.2.Serial port command mode.....	12
3.1.3.HTTP Client mode.....	12
3.1.4.Modbus TCP<=>Modbus RTU mode.....	12
3.1.5.AT command mode.....	13
3.2.Serial port.....	13
3.2.1.Serial port basic parameters.....	13
3.2.2.Serial Free-Frame mode.....	13
3.2.3.Serial package method.....	13
3.2.4.Baud rate synchronization function.....	14
3.3.Features.....	14
3.3.1.Search in LAN.....	14
3.3.2.Identity packet function.....	14
3.3.3.Usrlink.....	15
3.3.4.Keep-Alive function.....	16
3.3.5.Heartbeat packet function.....	16
3.3.6.Websocket function.....	16
3.3.7.Timeout reset function.....	16
4.Parameter configuration.....	17
4.1.Web Server.....	17

4.2.AT command	17
4.2.1.Serial AT command mode	17
4.2.2.Setup software	17
4.2.3.Network AT command mode	17
5.Contact Us	18
6.Disclaimer	18
7.Update History	18

Features

- Support WIFI@2.4GHz 802.11b/g/n wireless standards.
- Support TCP Server/TCP Client/UDP Server/UDP Client/HTTP Client mode.
- Support AP, STA, AP+STA.
- Support RS232 and RS485 serial ports.
- Support electrostatic protection.
- Support identity packet function.
- Support heartbeat packet function.
- Support Websocket function.
- Support timeout reset function, timing reset function.
- Support Web Server, setup software, serial/network AT command to configure module.
- Support hardware reload.
- Support usrlink.

1. Get Start

1.1. Application Diagram



Figure 1 Application diagram

1.2. Hardware

1.2.1. LED



LED	Description
Power	Power LED will light after powering the module successfully
Work	Work LED will blink every two seconds if module works normally.
Link	Link LED will light after module establishing WIFI connection
TXD	TXD LED will blink when module sends data from serial side
RXD	RXD LED will blink when module's serial side receives data

Figure 2 LED

1.2.2.Interface



Figure 3 Interface

1.2.3.Dimension

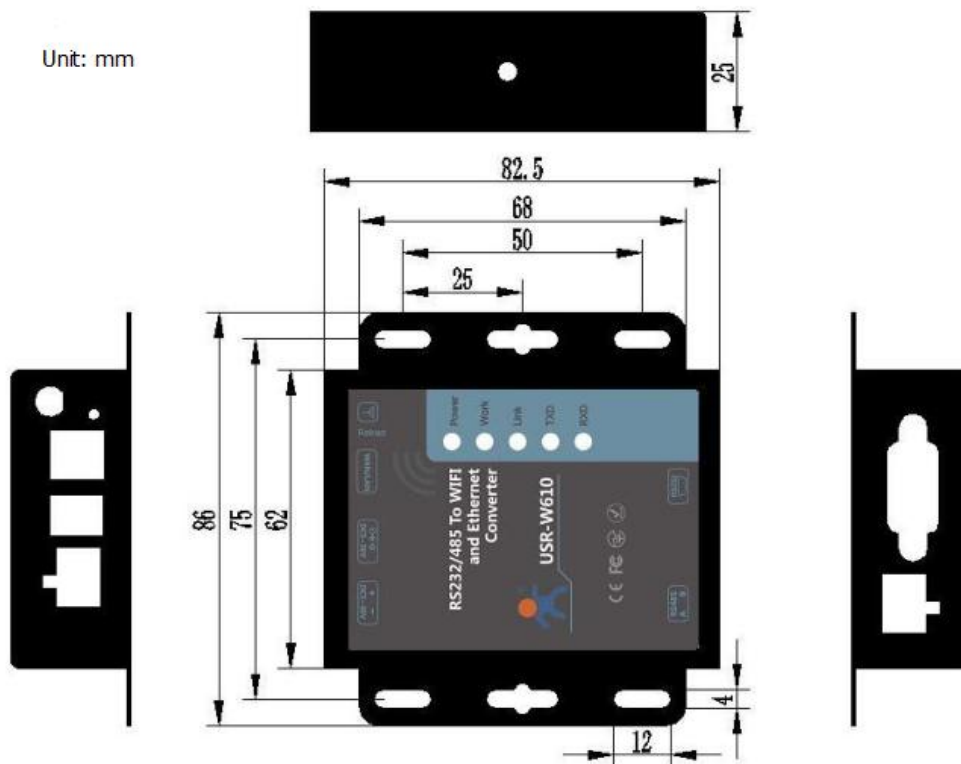

Figure 4 Dimension

2. Networking application

USR-W610 supports two wireless interface: one STA interface and one AP interface. And W610 also supports one 100M Ethernet interface.

- AP: Access point, central node of a wireless network. In general, wireless router is an AP and other wireless terminal can connect to each others through AP.
- STA: Station, terminal of a wireless network. Such as PDA, mobile phone.

2.1. Wireless networking

When W610 works in STA mode, W610 will adjust own channel to be same as AP's channel which W610 want to connect to. And when W610 works in AP mode, user can configure W610 to automatically choose channel and W610 will choose a channel according to surrounding environment.

2.1.1. AP mode

User can connect own devices as STA devices such as PC/PAD/phone to W610 works in AP mode directly to realize data transmission. After establishing connection successfully, user can enter W610 Web Server to configure the W610. User can also connect serial devices to W610 through RS232 or RS485 interface.

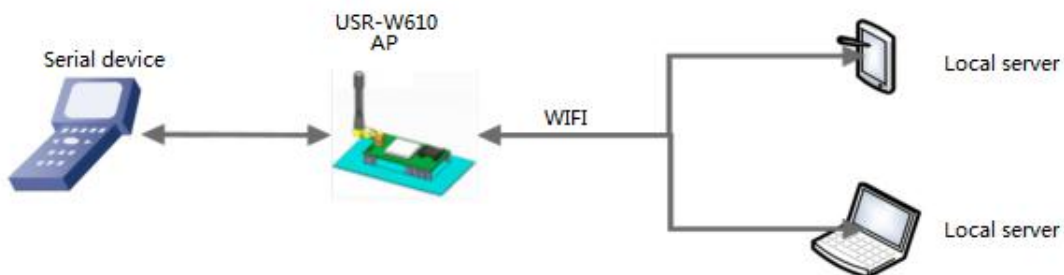

Figure 5 AP mode

2.1.2. STA mode

W610 works in STA mode can connect to an AP to realize communication with other devices which connect to same AP. And if this AP has connected to internet, USR-W610 can also access internet.

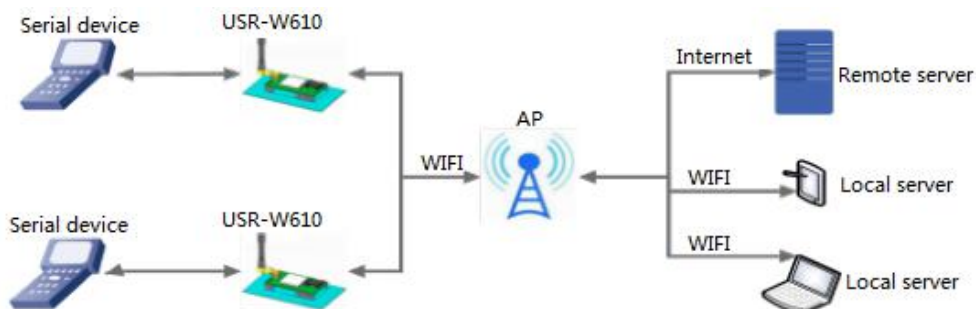

Figure 6 STA mode

2.1.3. AP+STA mode

W610 supports AP+STA mode which can enable an AP interface and a STA interface simultaneously. W610's STA interface can connect to an AP and AP interface can be connected by STA devices.

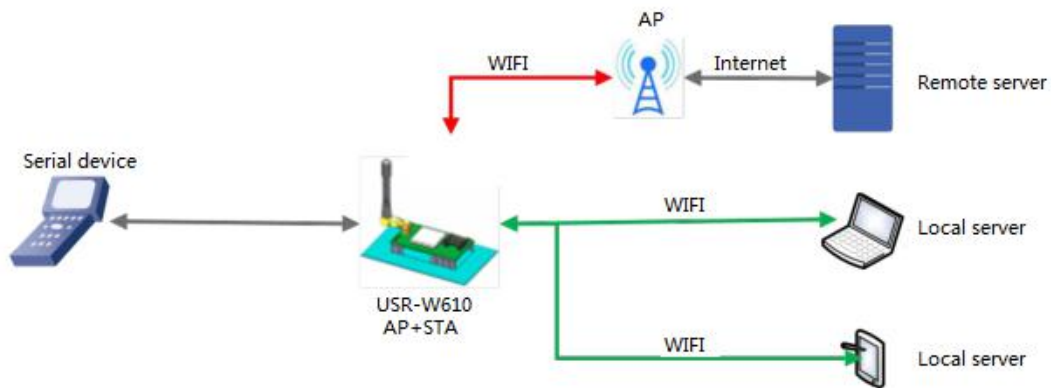

Figure 7 AP+STA mode

2.1.4.AP, STA application

User can configure two W610 one as AP and another as STA, then connect W610 in STA mode to W610 in AP mode to realize AP, STA application.

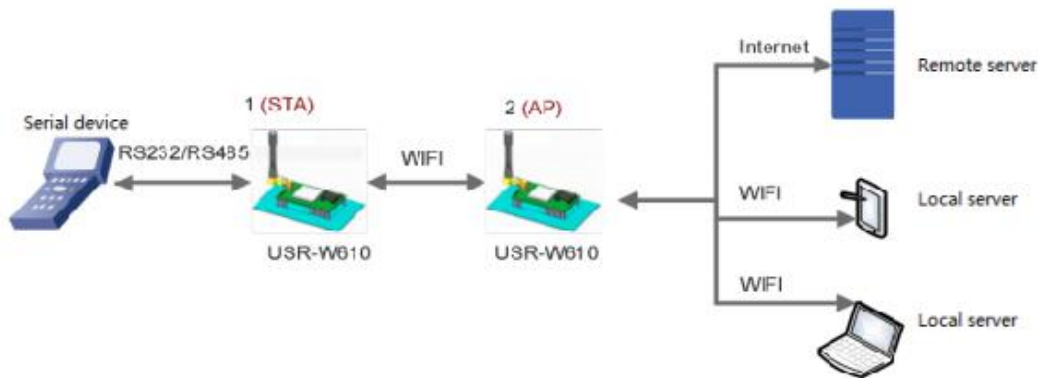

Figure 8 AP, STA application

2.1.5.Encryption mode

Encryption can make sure secure data transmission and improve communication security. W610 supports various encryption mode including:

- WPA-PSK/TKIP
- WPA-PSK/AES
- WPA2-PSK/TKIP
- WPA2-PSK/AES
- WEP

Note: When module adopts WEP encryption mode, HEX format is 10 bytes or 26 bytes password and ASCII format is 5 bytes or 13 bytes password; when module adopts WPA-PSK and WPA2-PSK encryption mode, password is at least 8 bytes.

2.2.Wired networking

2.2.1.AP+LAN

When W610 works in AP mode, other STA devices can connect to W610 through RJ45 or WIFI. In this network,

all devices will be distributed a IP in same network segment with W610. Application diagram as follow:

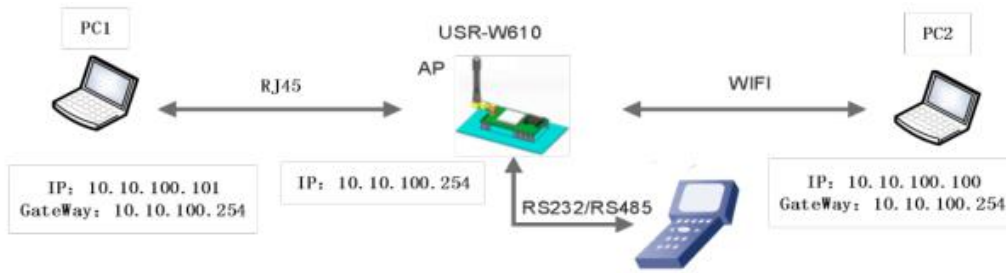

Figure 9 AP+LAN application

2.2.2.AP+WAN

User can configure W610 in AP mode and Ethernet interface in WAN interface(enable DHCP) to connect to internet. In this mode, W610 can work as second grade router and other STA device can connect to W610 AP interface to access internet.

After W610 connecting to first grade AP, W610 can get IP address from first grade AP. And W610 will distribute IP address to STA devices which connect to W610 AP interface. Application diagram as follow:

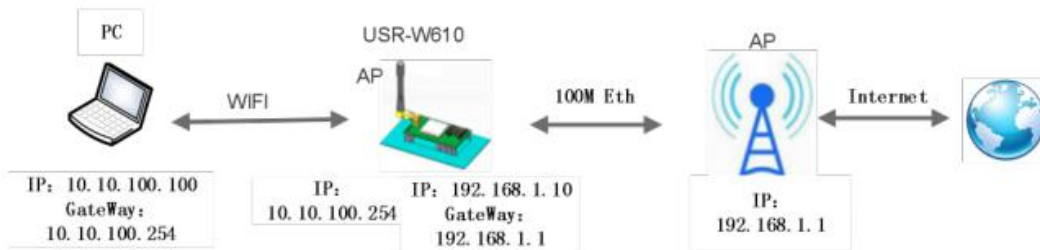

Figure 10 AP+WAN application

2.2.3.Route mode

W610 can work in STA mode with N-Ver version to apply route mode. W610 can get IP address from AP and distribute IP address to device which connect to W610 through Ethernet interface. Application diagram as follow:

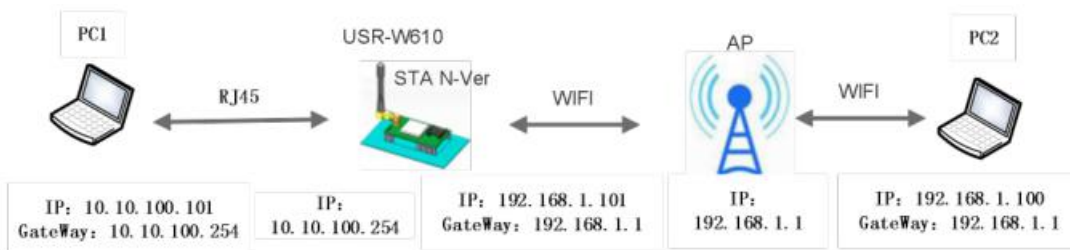

Figure 11 Route mode

Note: In above application diagram, PC1 can initiate a connection to PC2 but PC2 can't initiate a connection to PC1.

2.2.4.Bridge mode

W610 can work in STA mode with Z-Ver version to apply bridge mode. After connecting to AP, device which connect to W610 through Ethernet interface can get IP address from AP. In this whole network, PC1 and PC2 can

communicate to each other without limitation. If user want to achieve communicate between W610 to other devices, user need set LAN interface IP address of W610 into same network segment as AP. Application diagram as follow:

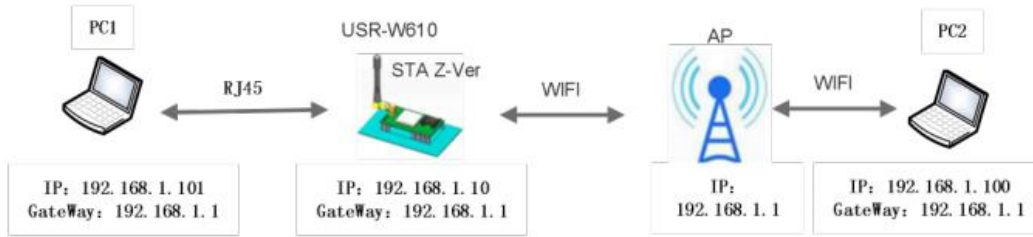

Figure 12 Bridge mode

3.Product Functions

3.1.Work mode

W610 supports five work modes: transparent transmission mode, serial port command mode, HTTP Client mode, Modbus TCP<=>Modbus RTU mode and AT command mode. Default work mode of module is transparent transmission mode. User can switch module between transparent transmission mode, serial port command mode, HTTP Client mode and Modbus TCP<=>Modbus RTU mode by Web Server or AT command. And when module works in transparent transmission mode, serial port command mode, HTTP Client mode or Modbus TCP<=>Modbus RTU mode, user can refer to <http://www.usriot.com/enter-serial-command-mode/> to enter AT command mode.

3.1.1.Transparent transmission mode

In this work mode, W610 can make a bidirectional connection between serial side and network side. This connection is transparent transmission. Data from serial device can be received in network, and network data can also be sent to serial device. This mode mainly used to realize data transmission between user serial device and fixed server through socket.

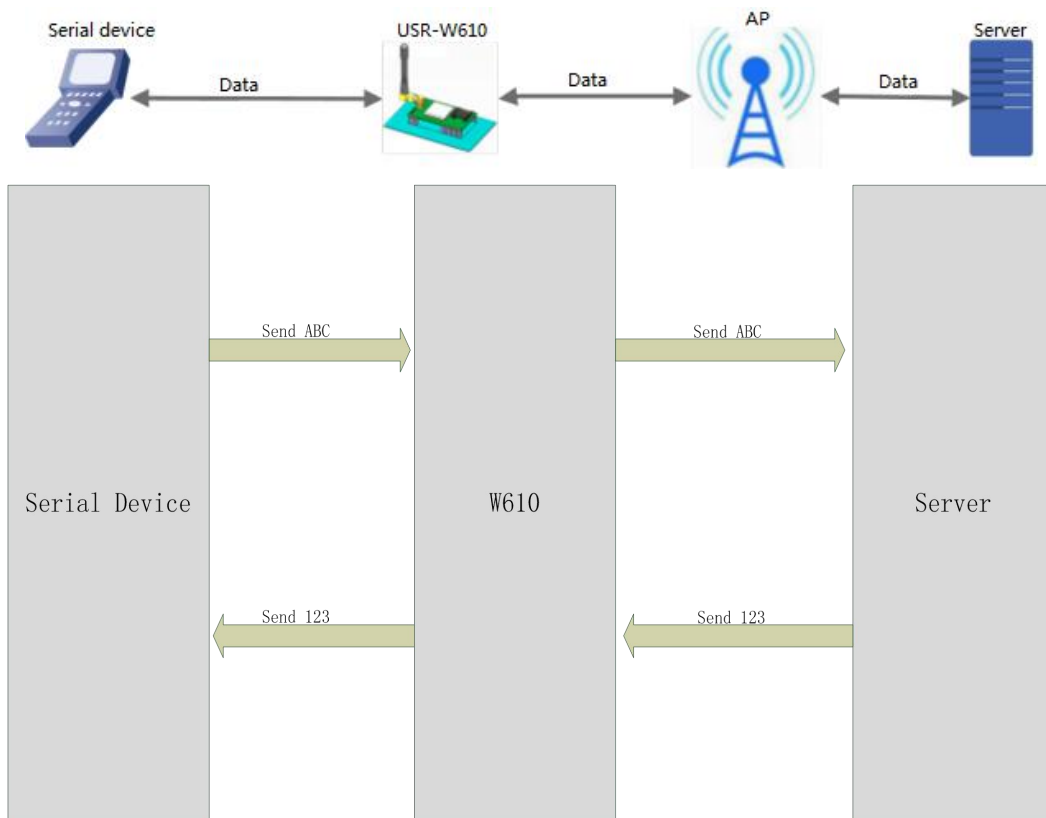

Figure 13 Transparent transmission mode

Note:

- Socket A supports: TCP Server, TCP Client, UDP Server, UDP Client. Socket A works in TCP Server mode supports at most 24 TCP Client connections.
- Socket B supports: TCP Client, UDP Client.

3.1.2. Serial port command mode

In this mode, W610 should work in UDP Client mode or TCP Client mode and user can send data in specified protocol format to different server without resetting.

If user send serial data in specified protocol format from serial device to W610, W610 will parse the data and send data after parsing to appointed server if data format is correct; if data isn't in correct format, W610 won't send to server side.

Note: serial port command mode is one of transparent transmission mode and it is different from AT command mode.

3.1.3. HTTP Client mode

In this work mode, user should configure the HTTP URL, HTTP header data, HTTP server address and HTTP server port firstly. Serial data can be packaged into HTTP format and sent to HTTP server through W610, HTTP server will also return data to W610.

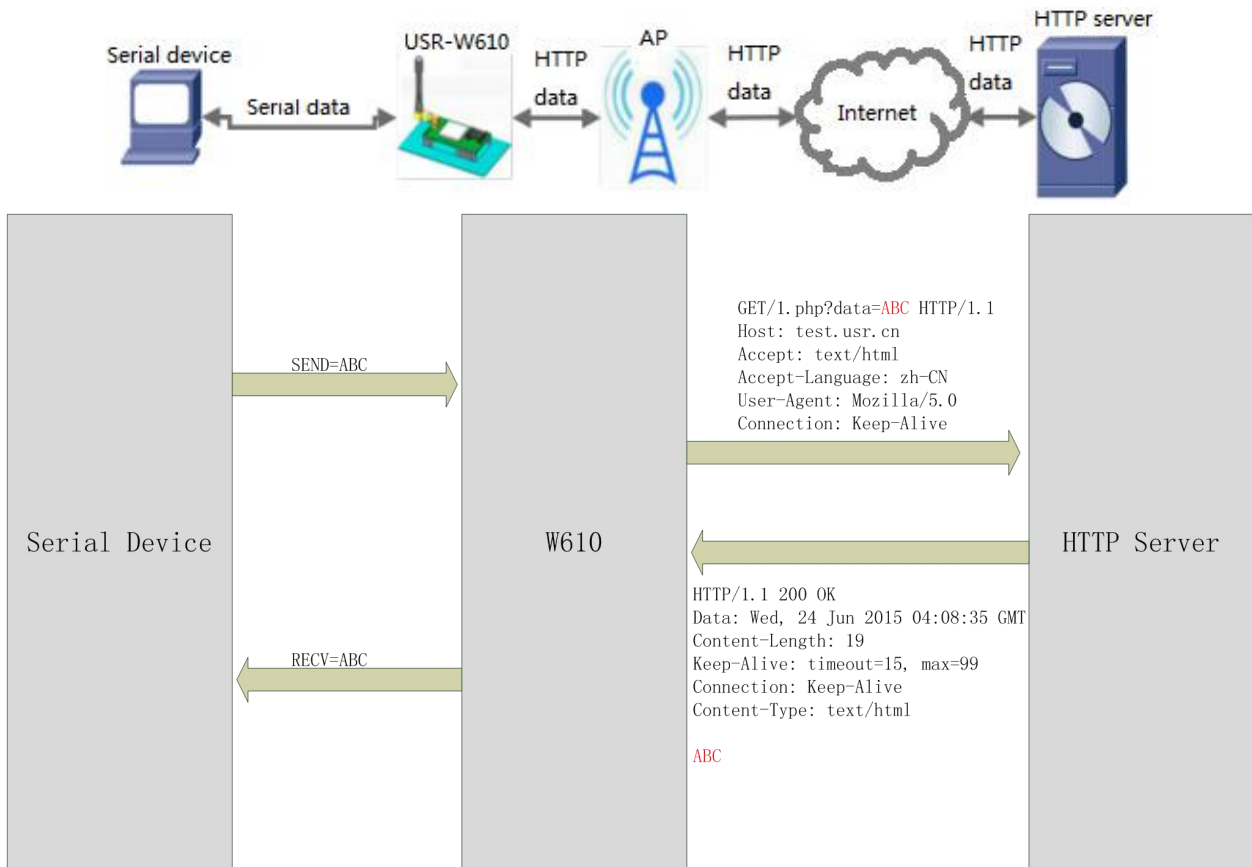
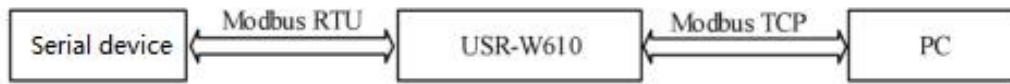

Figure 14 HTTP Client mode

3.1.4. Modbus TCP<=>Modbus RTU mode

W610 supports Modbus TCP<=>Modbus RTU mode (doesn't support Modbus ASCII). User just needs to configure W610 work mode to Modbus TCP<=>Modbus RTU mode and change related parameters (port, remote IP and some other parameters) to correct settings when user wants to use this mode.

Figure 15 Modbus TCP<=>Modbus RTU mode

3.1.5.AT command mode

User can enter AT command mode and send AT commands by serial to query/set W610 parameters(Enter AT command mode will disable transparent transmission mode and make serial port to send/receive AT commands). In this mode, all settings will be saved automatically and module will enter transparent transmission mode after sending AT+ENTM to exit AT command mode.

3.2.Serial port

3.2.1.Serial port basic parameters

Parameters	Range
Baud Rate	300, 600, 1200, 1800, 2400, 4800, 9600, 19200, 38400, 57600, 115200, 230400, 345600, 460800
Data Bits	5, 6, 7, 8
Stop Bits	1, 2
Parity Bits	None, Odd, Even
Flow Control	NFC: No flow control FC: Hardware flow control

Figure 16 Serial port basic parameters

3.2.2.Serial Free-Frame mode

W610 will continually check the interval between two adjacent bytes when W610 receives the data from serial side. If this interval > serial Free-Frame triggering time(Default is 50ms and user can use AT commend to configure triggering time), it will be considered as end of a package and W610 will send received data as a TCP package data to network. Otherwise W610 will receive data to 4K bytes and send these 4K bytes as a TCP package data to network.

Suppose n ms is serial package triggering time, if $T1 > n$, $T2 < n$, $T3 < n$, $T4 < n$, $T5 < n$, $T6 > n$, Byte1-Byte5 will be a package.

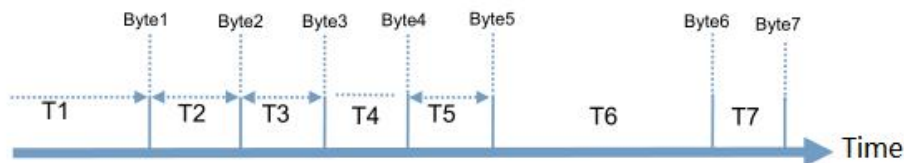
Figure 17 Serial Free-Frame mode

3.2.3.Serial package method

W610 supports serial package method(include Time Trigger Mode and Length Trigger Mode) and W610 will send received data as TCP package data to network if serial data arrive triggering time or triggering length.

3.2.4. Baud rate synchronization function

When module works with USR devices or software, serial parameters will change dynamically according to network protocol. User can modify serial parameters by sending data conformed to specific protocol via network. It is temporary, after resetting module, the parameters will back to original parameters.

3.3. Features

3.3.1. Search in LAN

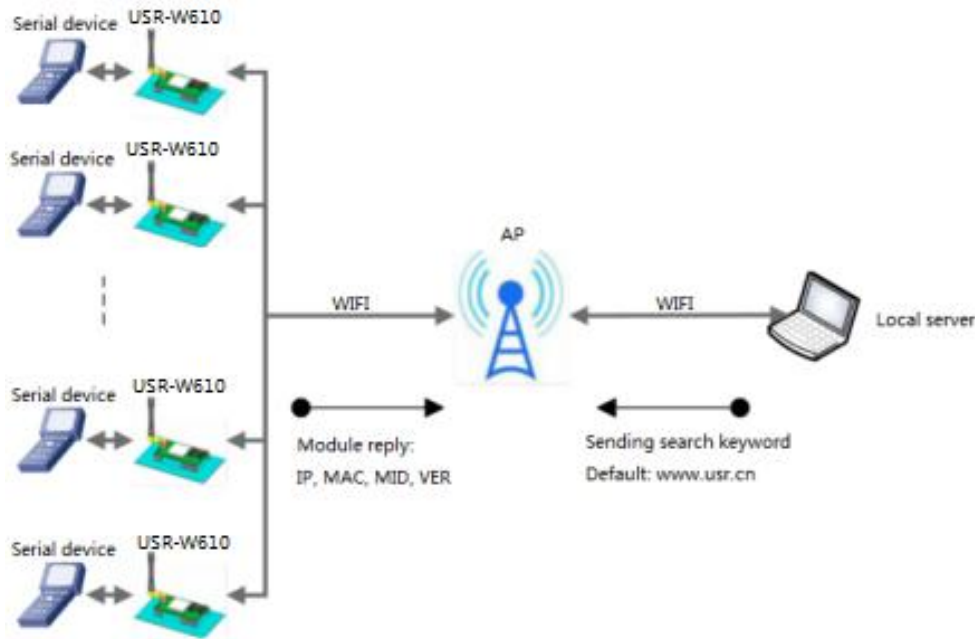

Figure 18 Search in LAN

W610 supports 'Search in LAN' function: After W610 connecting to an AP, user can send UDP broadcast to a fixed port to acquire W610's IP address in this AP's LAN. This function can realize searching module and communication. Default port is **48899** and default keyword is **www.usr.cn**.

The whole process as follows:

Step 1: User can send a keyword (default keyword: **www.usr.cn**, at most 20 bytes) by UDP broadcast way (broadcast address: xxx.xxx.xxx.255, default port: 48899) on a **device which in same LAN as W610**.

Step 2: After W610 receiving keyword, if keyword is correct, W610 will enter configuration mode and return IP, MAC, MID, Version to the device. And W610 will exit configuration mode if no configuration command over 30 seconds after W610 entering configuration mode.

Step 3: After user entering configuration mode, user can send network AT commands to query/set parameters. (The network AT commands format are same as serial AT commands)

3.3.2. Identity packet function

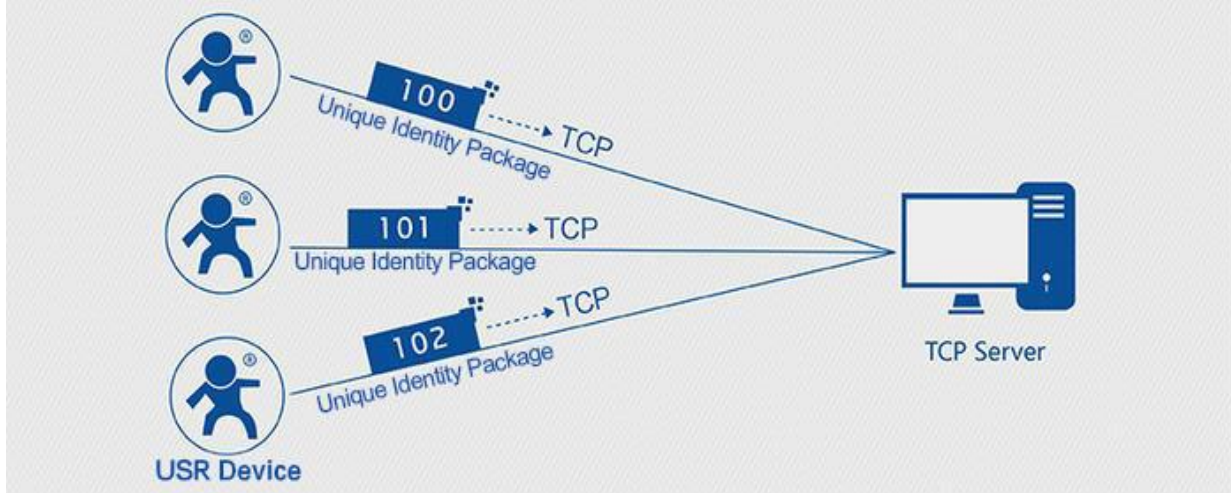

Figure 19 Identity packet application diagram

When W610 works in TCP Client mode, user can enable identity packet function. Identity packet is used for identifying the device when module works as TCP client. There are two methods to send identity packet.

- Identity packet will be sent after connection is established.
- Identity packet will be added on the front of every data package.

Identity packet can be 6 bytes MAC address identity packet, user editable identity packet(less than 40 bytes) or USR Cloud identity packet. MAC address identity packet and user editable identity packet can be sent by above both methods, but USR Cloud identity packet can be only sent after connection is established

3.3.3.Usrlink

When W610 works in AP mode will open a UDP port to receive usrlink commands(Port number 48899, same as 'Search in LAN' function and can be changed).



Figure 20 Usrlink

The whole process as follows:

Step 1: User should directly connect phone which has download UsrAutoLink APP to W610 in AP mode through WIFI.

Step 2: Query the surrounding SSID.

Step 3: Choose the SSID, enter password and phone will send the configuration parameters to W610.

Step 4: After receiving configuration parameters protocol, W610 will pares it and acquire the AP's SSID and password, save them to flash, then reset and connect to AP.

3.3.4.Keep-Alive function

W610 supports Keep-Alive function of TCP connection. W610 will disconnect to network when network connection exceptions occur and will also reconnect to server after network connection restoring.

3.3.5.Heartbeat packet function

Heartbeat packet: In transparent transmission mode, module can output heartbeat packet to serial side or network side periodic. User can configure the heartbeat packet data(less than 40 bytes and in HEX format) and sending interval(1~65535s).

- Serial heartbeat packet can be used for polling Modbus data or other querying commands.
- Network heartbeat packet can be used for showing connection status and keeping the connection (only take effect in TCP/UDP Client mode). When connection exceptions happen, W610 can't send heartbeat packet to network server successfully and will reconnect to server after sending unsuccessfully over three times.

3.3.6.Websocket function

W610 supports Websocket server function which can realize real-time communication between serial side and web page and user can use this function in W610 Web Server(Websocket function occupies W610 port 8000). Websocket server supports at most 8 client connections simultaneously.

3.3.7.Timeout reset function

After enabling timeout reset function in transparent transmission mode, if W610 has no WIFI connection or has WIFI connection but no data transmission and these two situations last over a setting time, W610 will reset. This time is range from 60~65535s and default is 3600s.

4.Parameter configuration

There are two ways to configure USR-W610. They are Web Server and AT command.

4.1.Web Server

User can connect PC to W610 through AP interface and enter Web Server to configure.

Web Server default parameters as follows:

Parameter	Default settings
SSID	USR-W610_xxxx(4 bytes MAC address)
Web Server IP address	10.10.100.254
Username	admin
Password	admin

Figure 21 Web server default parameters

After firstly connecting PC to W610, user can open browser and enter default IP 10.10.100.254 into address bar, then log in username and password, user will enter Web Server.

4.2.AT command

We have specific user manual for AT commands.

4.2.1.Serial AT command mode

In work mode, user can enter AT command mode and send AT commands to module to configure the module.

For entering AT command mode, please refer to this FAQ:

<http://www.usriot.com/enter-serial-command-mode/>.

4.2.2.Setup software

We also provide setup software for W610 which based on [serial AT commands](#).

4.2.3.Network AT command mode

User can also use network AT command to configure W610. User can search W610 by sending UDP broadcast to a fixed port and then send AT commands to configure W610.

5.Contact Us

Company: Jinan USR IOT Technology Limited

Address: Floor 11, Building 1, No. 1166 Xinluo Street, Gaoxin District, Jinan, Shandong, 250101, China

Web: www.usriot.com

Support: h.usriot.com

Email: sales@usr.cn

Tel: 86-531-88826739/86-531-55507297

6.Disclaimer

This document provides the information of USR-W610 products, it hasn't been granted any intellectual property license by forbidding speak or other ways either explicitly or implicitly. Except the duty declared in sales terms and conditions, we don't take any other responsibilities. We don't warrant the products sales and use explicitly or implicitly, including particular purpose merchant-ability and marketability, the tort liability of any other patent right, copyright, intellectual property right. We may modify specification and description at any time without prior notice.

7.Update History

2017-12-04 V1.0.1.01 established based on Chinese version V1.0.1.