

Wide input voltage , non-isolated & regulated single output

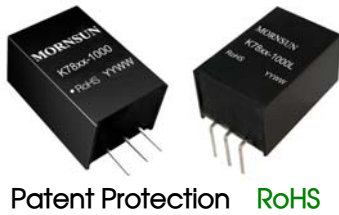

FEATURES

- Efficiency up to 97%
- Operating temperature range: -40°C to +85°C
- Pin-out compatible with LM78XX series
- Short circuit protection and overheat protection
- Low ripple & noise
- Subminiature SIP package, meeting requirements of UL94-V0
- No heatsink required
- Industry standard pinout
- MTBF>2,000,000 hours
- Supporting negative output perfectly

K78xx-1000 (L) series are high efficiency switching regulators and ideal substitutes of LM78XX series three-terminal linear regulators. The product is featured with high efficiency, low loss, low radiation and no heat sink requirement. They are widely used in industrial control, instrumentation, and electric power applications.

Selection Guide

Part No.	Input Voltage (VDC)		Output		Efficiency (%/Typ.) (Min. Vin)/ (Max. Vin)	Max. Capacitive Load(μF)
	Nominal	Range	Output Voltage (VDC)	Output Current (mA)		
K7801-1000(L)	12	4.75-26	1.5	1000	80/71	1000
	12	4.75-24	-1.5	-800	72/71	680
K78X2-1000(L)	12	4.75-26	1.8	1000	83/74	1000
	12	4.75-24	-1.8	-800	74/73	680
K7803-1000(L)	24	4.75~28	3.3	1000	90/83	1000
	12	4.75-25	-3.3	-600	80/82	680
K7805-1000(L)	24	6.5~32	5.0	1000	93/88	1000
	12	7-27	-5.0	-600	82/85	680
K78X6-1000(L)	24	9.0~32	6.5	1000	94/90	1000
	12	7-25	-6.5	-400	87/87	680
K7809-1000(L)	24	12~32	9.0	1000	95/92	1000
	12	7-23	-9.0	-400	87/90	680
K7812-1000(L)	24	16~32	12	1000	96/94	1000
	12	7-20	-12	-300	87/90	680
K7815-1000(L)	24	20~32	15	1000	97/94	1000
	12	7-17	-15	-300	87/91	680

Note:*Add suffix "L" for 90° bend pins, for example: K7805-1000L.

Input Specifications

Item	Operating Conditions	Min.	Typ.	Max.	Unit
No-load Power Consumption	Input voltage range	--	0.19	0.256	W
Reverse Polarity Input		Forbidden			
Input Filter		Capacitor filter			

Output Specifications

Item	Operating Conditions	Min.	Typ.	Max.	Unit
Output Voltage Accuracy	100% load, input voltage range	--	±2	±3	%
Line Regulation	Input voltage range	--	±0.2	±0.4	
Load Regulation	10%-100% load	--	±0.4	±0.6	

Ripple & Noise*	20MHz bandwidth (refer to Fig. 2)	Positive output	--	25	35	mVp-p
		Negative output	--	25	45	
Temperature Drift Coefficient	-40°C to +85°C	--	--	±0.02		%/°C
Over temperature Protection	IC built-in	--	150	--	--	°C
Output short circuit protection	Continuous, self-recovery					

Note: * Ripple and noise tested with "parallel cable" method, please see *DC-DC Converter Application Notes* for specific operation methods.

General Specifications

Item	Operating Condition	Min.	Typ.	Max.	Unit
Operating Temperature	Derating if the temperature $\geq 71^\circ\text{C}$ (see Fig. 1)	-40	--	85	°C
Storage Temperature		-55	--	125	
Max. Operating Temperature for casing	Within the operating temperature curve	--	--	100	
Pin Welding Resistance Temperature	Welding spot is 1.5mm away from the casing, 10 seconds	--	--	300	
Storage Humidity	Non-condensing	--	--	95	%RH
Switching Frequency	100% load, input voltage range	280	330	450	KHz
MTBF	MIL-HDBK-217F@25°C	2000	--	--	K hours

Physical Specifications

Casing Material	Black flame-retardant and heat-resistant plastic (UL94-V0)				
Package Dimensions	K78XX-1000	11.50*9.00*17.50 mm			
	K78XX-1000L	17.50*11.50*9.00 mm			
Weight	3.70g (Typ.)				
Cooling Method	Free air convection				

EMC Specifications

EMI	Conducted Disturbance	CISPR22/EN55022	CLASS B (see Fig. 6-② for recommended circuit)		
	Radiated Emission	CISPR22/EN55022	CLASS B (see Fig. 6-② for recommended circuit)		
EMS	Electrostatic Discharge	IEC/EN 61000-4-2	Contact $\pm 4\text{KV}$		perf. Criteria B
	Radiation Immunity	IEC/EN 61000-4-3	10V/m		perf. Criteria A
	EFT	IEC/EN 61000-4-4	$\pm 1\text{KV}$ (see Fig. 6-① for recommended circuit)		perf. Criteria B
	Surge Immunity	IEC/EN 61000-4-5	$\pm 1\text{KV}$ (see Fig. 6-① for recommended circuit)		perf. Criteria B
	Conducted Disturbance Immunity	IEC/EN 61000-4-6	3Vr.m.s		perf. Criteria A
	Voltage dip, drop and short interruption	IEC/EN 61000-4-29	0%-70%		perf. Criteria B

Product Characteristic Curve

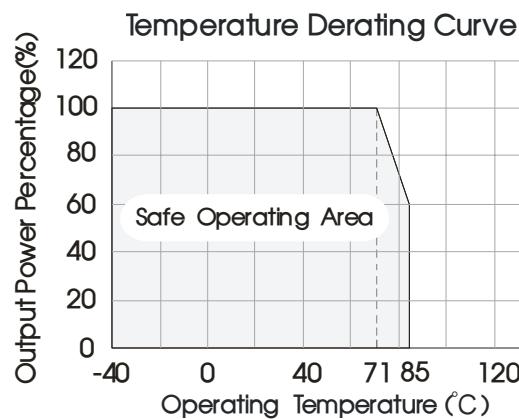
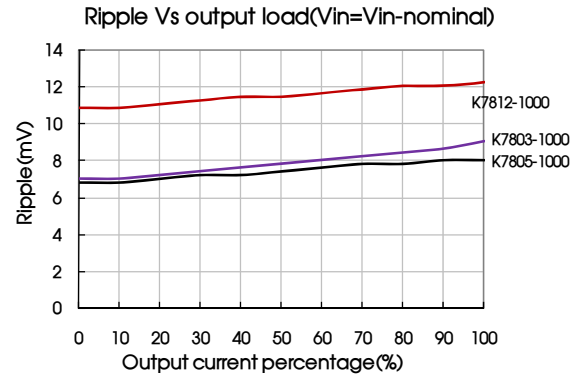
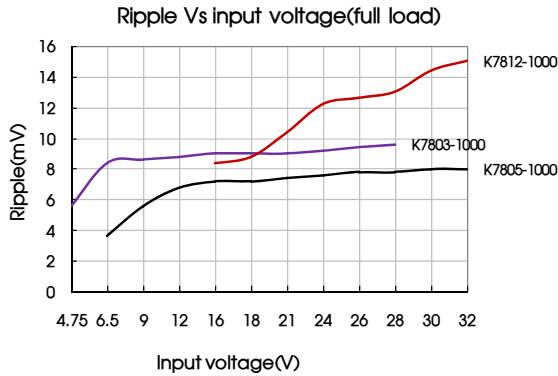
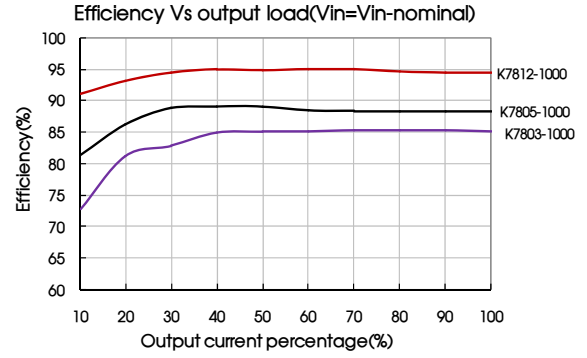
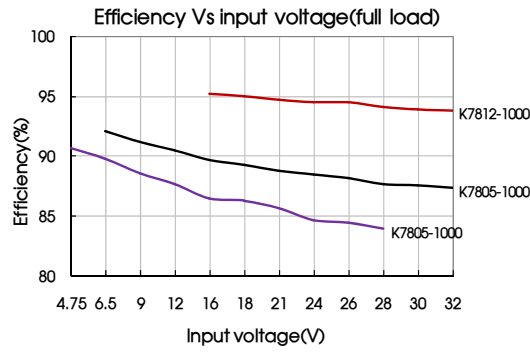
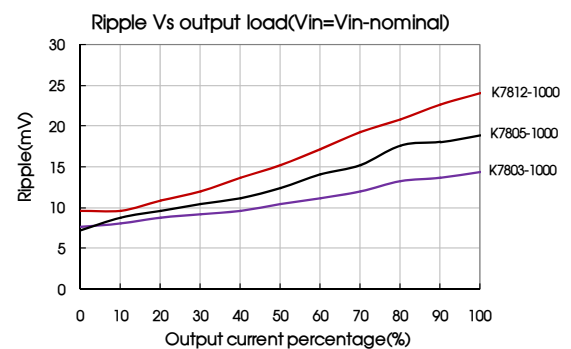
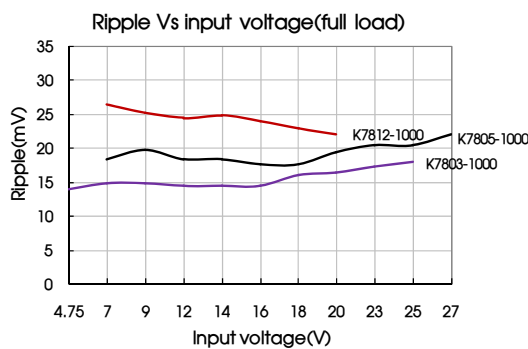
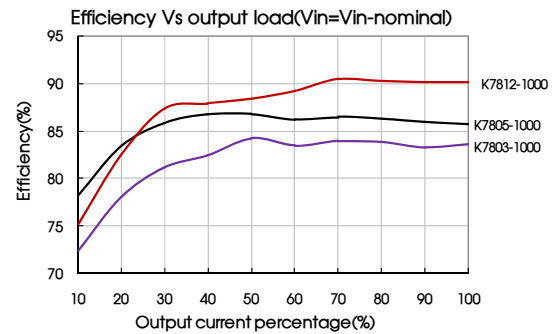
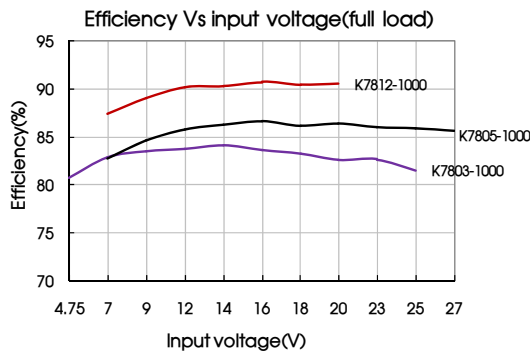

Fig. 1

Positive output character curve



Negative output character curve



Design Reference

1. Typical application circuit

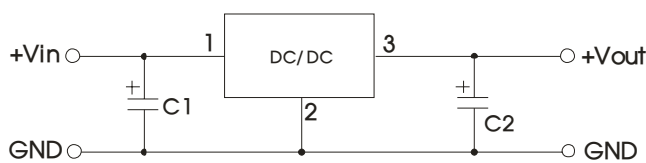

Fig. 2 Positive output application circuit

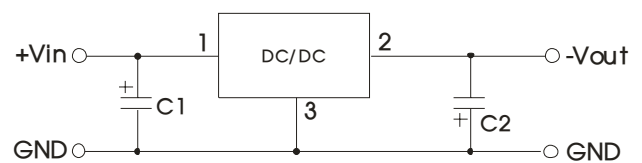

Fig. 3 Negative output application circuit

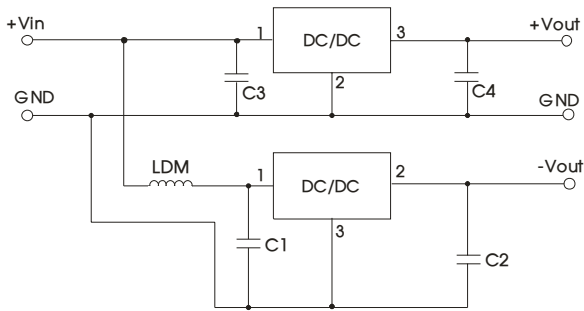

Fig. 4 Positive and Negative output paralleling application circuit

Part No.	C1,C3 (ceramic capacitor)	C2,C4 (ceramic capacitor)
K7801-1000(L)	10 μ F/50V	22 μ F/6.3V
K78X2-1000(L)		22 μ F/6.3V
K7803-1000(L)		22 μ F/6.3V
K7805-1000(L)		22 μ F/16V
K78X6-1000(L)		10 μ F/16V
K7809-1000(L)		10 μ F/16V
K7812-1000(L)		10 μ F/25V
K7815-1000(L)		10 μ F/25V

- Note:
- When the products used as negative output and the input-voltage under ($V_{in-min}+2V$), C1 and C2 must be added in the circuit, and they should be placed as near as the products' footprints. Others apply to the application-environment.
 - The capacitance of C1,C2 sees external capacitor table, it can be increased properly if required, and tantalum or low ESR electrolytic capacitors may also suffice.
 - When the products used as the circuit like figure 7, an inductor named as LDM up to 10 μ H is recommended in the circuit to reduce the mutual interference.
 - If the input voltage close to the maximum input voltage (for $V_o \leq 3.3V$, the input voltage is greater than 26V; for the Others, the input voltage greater than 28V) the input must be applied an electrolytic capacitor ($\geq 22\mu F$) to protect the module from damaged by voltage spikes.
 - Cannot use in parallel for output and hot swap for input.

To reduce the output ripple furtherly, it is suggested to connect a "LC" filter at the output terminal, and recommended value of L is 10 μ H-47 μ H.

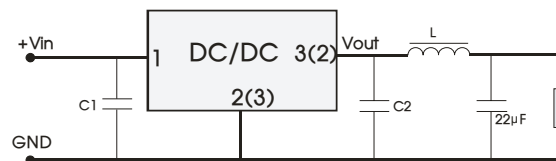

Fig. 5

2. EMC solution-recommended circuit

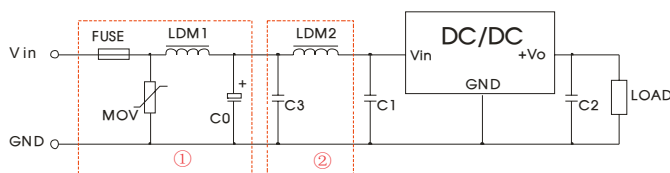

Fig. 6 Recommended EMC circuit

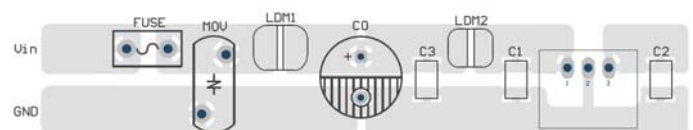

Fig.7 Recommended EMC circuit-PCB layout

FUSE	MOV	LDM1	C0	C3	C1/C2	LDM2
Selected based on the actual input current from the customer	S10K35	82 μ H	680 μ F /50V	4.7 μ F /50V	Refer to Fig. 2	12 μ H

Note: Part ① in the Fig. 1 is for EMS test, part ② is for EMI filtering; parts ① and ② can be added based on actual requirement.

3. Test Configurations (TA=25°C)

1) Efficiency and Output Voltage Ripple Test

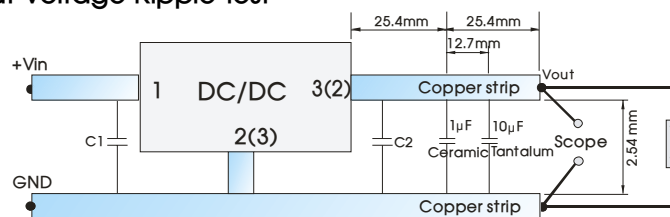

Fig. 8

2) 2.Start-up and Load Transient Response Test

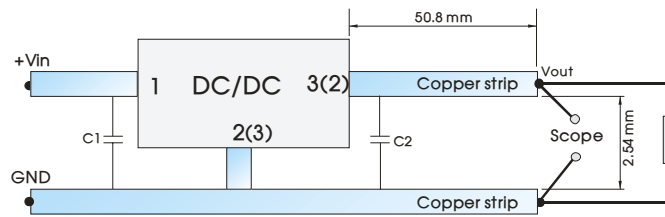
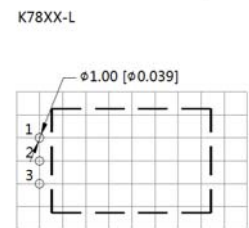
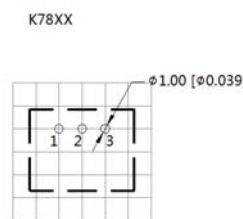
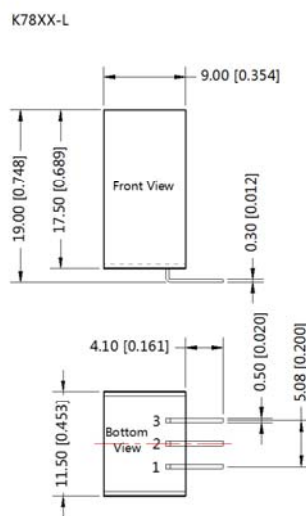
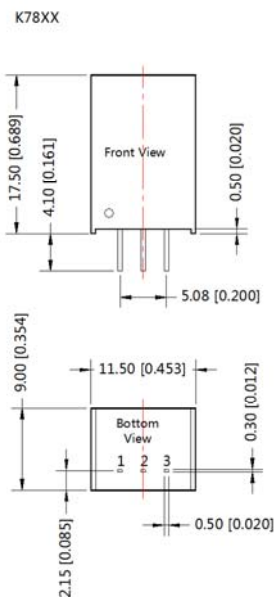

Fig. 9

4. For more information please find the application notes on www.mornsun-power.com

Dimensions and Recommended Layout



Note : Grid 2.54*2.54mm

Pin-Out		
Pin	+Output	-Output
1	Vin	Vin
2	GND	-Vo
3	+Vo	GND

Note:
Unit :mm[inch]
Pin diameter tolerances :±0.10[±0.004]
General tolerances:±0.25[±0.010]

Notes:

1. Packing Information please refer to 'Product Packing Information'. Packing bag number:58210021(K78xx-1000),58210027(K78xx-1000L);
2. The max. capacitive load should be tested within the input voltage range and under full load conditions;
3. Unless otherwise specified, data in this datasheet should be tested under the conditions of Ta=25°C, humidity<75% when inputting nominal voltage and outputting rated load;
4. All index testing methods in this datasheet are based on our Company's corporate standards;
5. The performance indexes of the product models listed in this manual are as above, but some indexes of non-standard model products will exceed the above-mentioned requirements, and please directly contact with our technician for specific information;
6. We can provide product customization service;
7. Specifications of this product are subject to changes without prior notice.

Mornsun Guangzhou Science & Technology Co., Ltd.

Address: No. 5, Kehui St. 1, Kehui Development Center, Science Ave., Guangzhou Science City, Luogang District, Guangzhou, P. R. China
Tel: 86-20-38601850-8801 Fax: 86-20-38601272 E-mail: info@mornsun.cn