

# TA7769P

## DUAL AUDIO POWER AMPLIFIER

TA7769P is dual audio power amplifier designed for the audio power amplifier of portable radio cassette tape recorder.

- . High Output Power :  $P_{OUT}=1.0W$ (Typ.)  
( $V_{CC}=6V$ ,  $R_L=4\Omega$ ,  $f=1kHz$ ,  $THD=10\%$ )
- . Built-in Thermal Shut Down Protection Circuit
- . Small Pop Noises at Power Supply ON
- . Soft Clip
- . Wide Operating Supply Voltage Range :  $V_{CC}=4.5\sim 9.0V$

Unit in mm

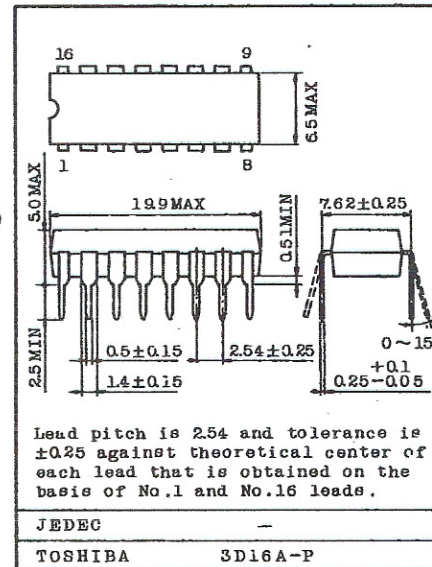

Weight: 1.0g

### MAXIMUM RATINGS ( $T_a=25^\circ C$ )

| CHARACTERISTIC                                     | SYMBOL    | RATING    | UNIT       |
|--|-----------|-----------|------------|
| Supply Voltage                                     | $V_{CC}$  | 14        | V          |
| Power Dissipation (Note 1)<br>(Package Limitation) | $P_D$     | 3.6       | W          |
| Operating Temperature                              | $T_{opr}$ | -25 ~ 75  | $^\circ C$ |
| Storage Temperature                                | $T_{stg}$ | -55 ~ 150 | $^\circ C$ |

Note 1 : Value for mounting on PC board with Cu Fin.  
(Refer to  $P_D$ - $T_a$  curve)

◀AUDIO LINEAR IC▶

# TA7769P

## ELECTRICAL CHARACTERISTICS

(Unless otherwise specified,  $V_{CC}=6V$ ,  $R_L=4\Omega$ ,  $R_g=600\Omega$ ,  $f=1kHz$ ,  $T_a=25^\circ C$ )

| CHARACTERISTIC            | SYMBOL        | TEST CIR-CUIT | TEST CONDITION                                     | MIN. | TYP. | MAX. | UNIT       |
|---------------------------|---------------|---------------|--|------|------|------|------------|
| Quiescent Current         | $I_{CCQ}$     | -             | $V_{IN}=0$   | -    | 30   | 55   | mA         |
| Output Power              | $P_{OUT(1)}$  | -             | THD=10%  | 0.7  | 1.0  | -    | W          |
|                           | $P_{OUT(2)}$  |               | THD=10%, $R_L=3\Omega$                             | -    | 1.2  | -    |            |
|                           | $P_{OUT(3)}$  |               | THD=10%, $R_L=8\Omega$                             | -    | 0.62 | -    |            |
|                           | $P_{OUT(4)}$  |               | THD=10%, $V_{CC}=7.5V$<br>$R_L=8\Omega$            | -    | 0.96 | -    |            |
| Total Harmonic Distortion | THD           | -             | $P_{OUT}=0.25W$ , $G_V=45dB$                       | -    | 0.15 | 1.0  | %          |
| Voltage Gain              | $G_V(1)$      | -             | $R_f=82\Omega$ , $V_{OUT}=0.775V_{rms}$            | 43   | 45   | 47   | dB         |
|                           | $G_V(2)$      |               | $R_f=0$ , $V_{OUT}=0.775V_{rms}$                   | -    | 56.5 | -    |            |
| Cross Talk                | C.T.          | -             | $V_{OUT}=0.775V_{rms}$                             | -    | -60  | -    | dB         |
| Ripple Rejection Ratio    | R.R.          | -             | $V_{Rip}=245mV_{rms}$<br>$f_{Rip}=100Hz$           | -    | -55  | -40  | dB         |
| Output Noise Voltage      | $V_{NO}$      | -             | $R_g=10k\Omega$ , $G_V=45dB$<br>$BW=20 \sim 20kHz$ | -    | 0.4  | 0.7  | $mV_{rms}$ |
| Input Resistance          | $R_{IN}$      | -             |  | -    | 30   | -    | $k\Omega$  |
| Input Offset Voltage      | $V_7, V_{10}$ | -             |  | -    | 30   | -    | mV         |

## TYPICAL DC VOLTAGE OF EACH TERMINAL

( $V_{CC}=6V$ ,  $T_a=25^\circ C$  by Test Circuit)

| TERMINAL No.  | 1  | 2   | 3    | 4 | 5 | 6    | 7    | 8    | 9 | 10   | 11   | 12 | 13 | 14   | 15  | 16  |
|---------------|----|-----|------|---|---|------|------|------|---|------|------|----|----|------|-----|-----|
| DC Voltage(V) | NC | 3.0 | 5.75 | 0 | 0 | 0.65 | 0.03 | 5.95 | 0 | 0.03 | 0.65 | 0  | 0  | 5.75 | 3.0 | 6.0 |

# TA7769P

## TEST CIRCUIT & BLOCK DIAGRAM

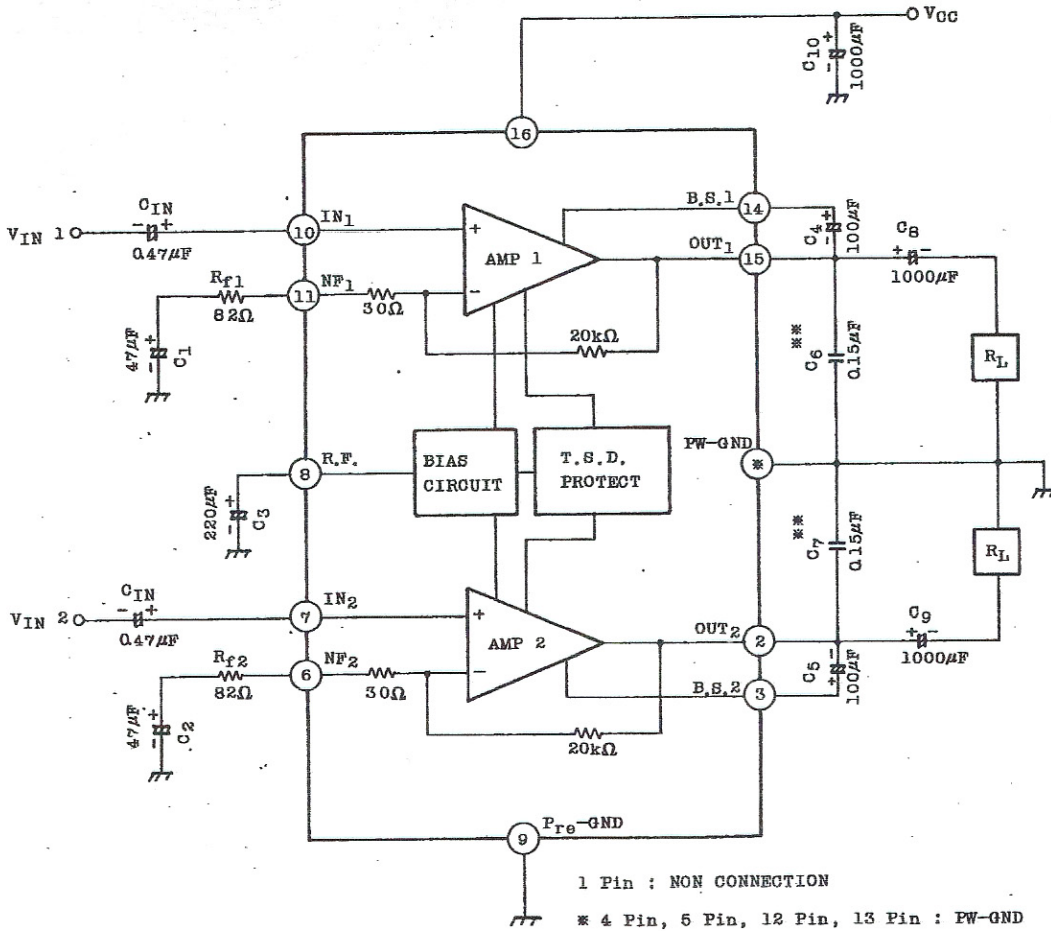

\*\* For C<sub>6</sub> and C<sub>7</sub>, it is advised to use polyester film capacitor having superior quality in the characteristics of high frequency and temperature.

≡ AUDIO LINEAR IC ≡

# TA7769P

## PRECAUTIONS FOR USE AND APPLICATION

### 1) Input Stage

The input stage of power amplifier is comprised of a PNP differential pair preceded by a PNP emitter follower which allows DC referencing of the source signal to ground. This eliminates the need for an input coupling capacitor. However, in case the brush noise of volume becomes a problem, provide serially a coupling capacitor to the input side.

### 2) Adjustment of Voltage Gain

The voltage gain is fixed at  $G_v=56.5\text{dB}$  by the resistors ( $R_1$  and  $R_2$ ) in IC, however, its reduction is possible through adding  $R_f$  as shown in Figure 1. In this case, the voltage gain is obtained by the following equation.

$$G_v = 20\log \frac{R_1+R_2+R_f}{R_1+R_f}$$

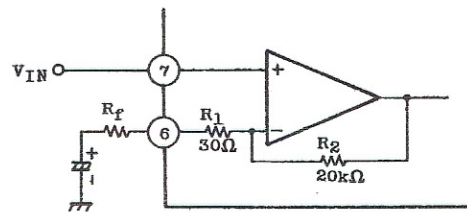

Figure 1

It is recommended to use this IC with the voltage gain of  $G_v=40\text{dB}$  or over.

### 3) Measures Against Oscillation

For the capacitors  $C_6$  and  $C_7$  to be applied for preventing the oscillation between output terminal and GND, use the polyester film capacitor having superior quality in high frequency and temperature characteristics, however, since the characteristics of the capacitor may be different depending on the manufactures or kinds, apply the capacitor after confirmation.

Since the characteristics of the capacitor of the ceramic type are liable to be affected by the temperature and the voltage, use the capacitor of larger capacity and be sure to perform the thermal test to check the oscillation allowance.

# TA7769P

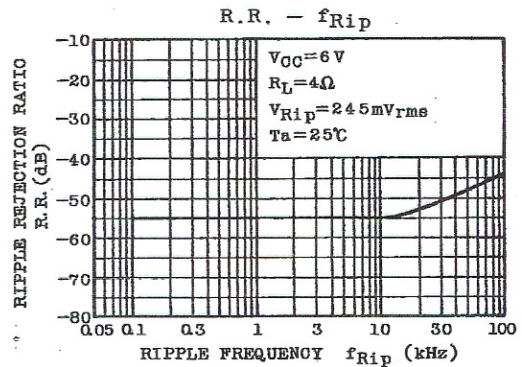
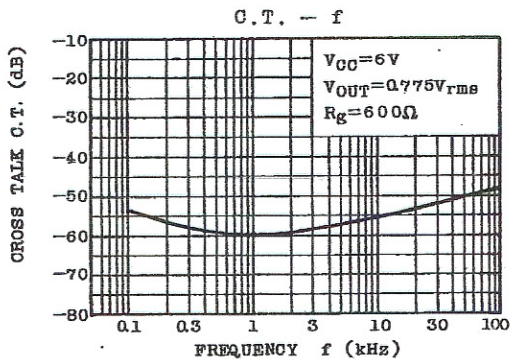
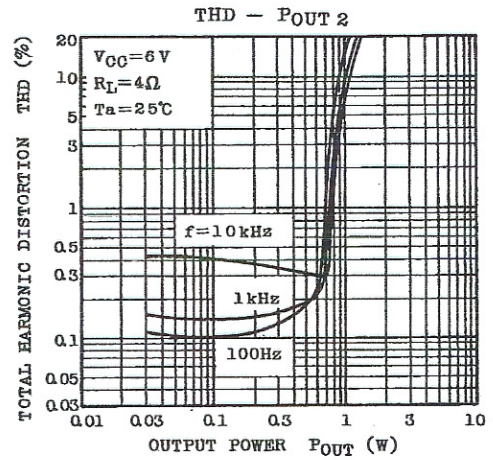
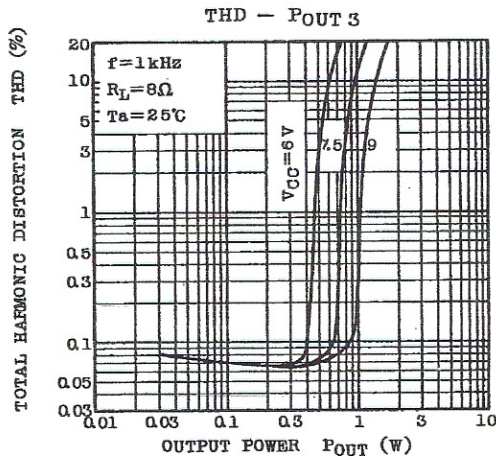
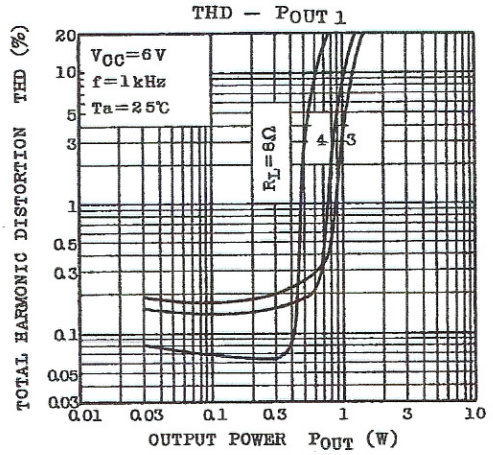
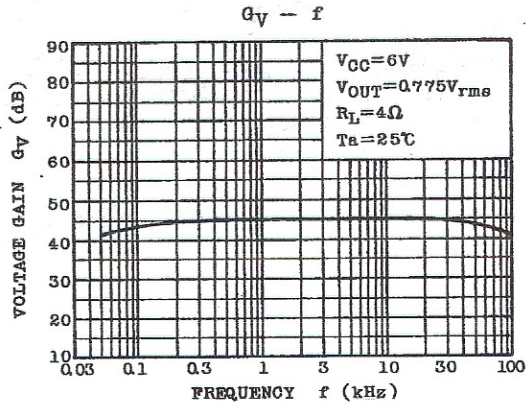

**AUDIO LINER IC**

# TA7769P

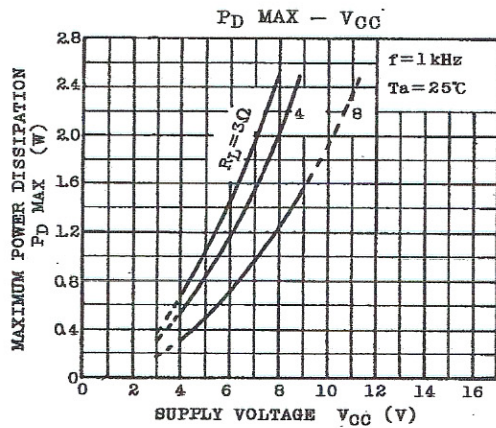
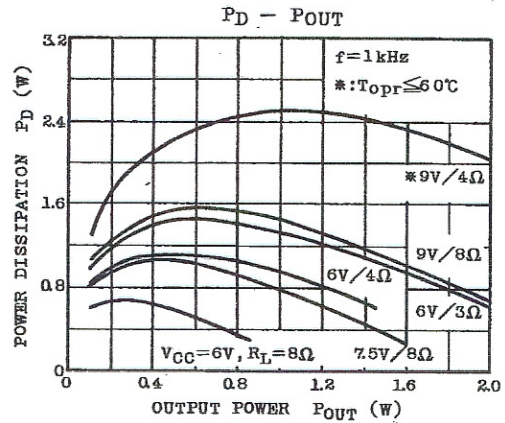
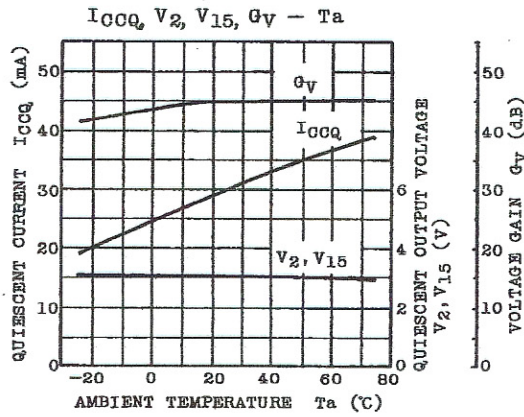
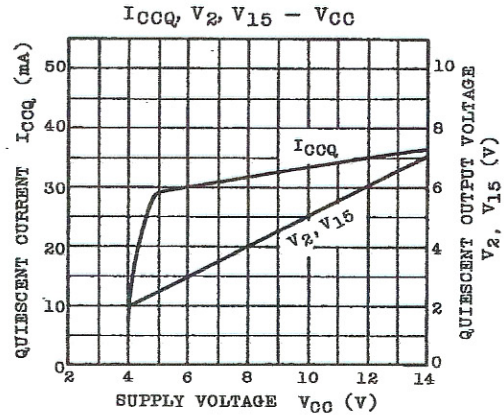
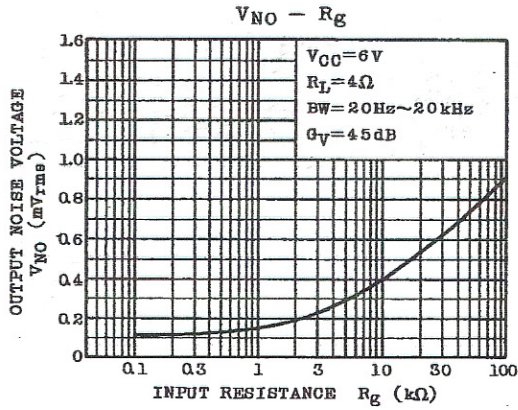

**TOSHIBA**

# TA7769P

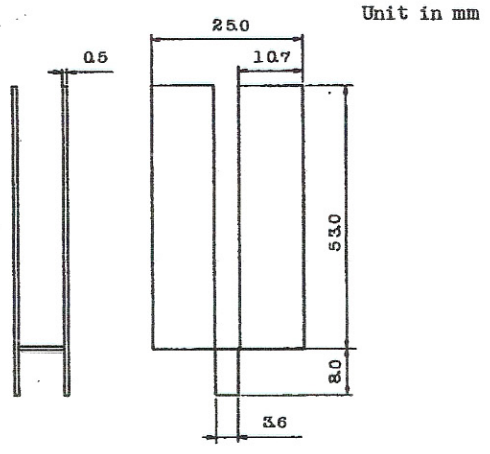
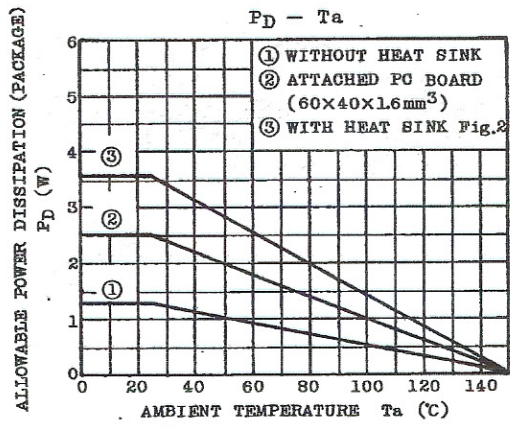

Figure 2