

Wide input voltage , non-isolated & regulated single output



**UL** **us** **CB** **CE** Patent Protection **RoHS**

## FEATURES

- High efficiency up to 96%
- No-load input current as low as 0.1mA
- Operating temperature range: -40°C to +85°C
- Support the negative output
- Output short circuit protection
- Pin-out compatible with LM78XX linear regulators
- IEC60950, UL60950, EN60950 approval

K78xx-1000R3(L) series are high efficiency switching regulators and ideal substitutes of LM78xx series three-terminal linear regulators. The product is featured with high efficiency, low loss and no heat sink requirement. They are widely used in industrial control, instrumentation, and electric power applications.

## Selection Guide

Certification	Part Number	Input Voltage (VDC)	Output		Efficiency (%/Typ.) (Min. Vin)/ (Max. Vin) @Full Load	Max. Capacitive Load(μF)
		Nominal (Range)	Output Voltage (VDC)	Max. Output Current (mA)		
UL/CE/CB	K7803-1000R3(L)	24 (6-36)	3.3	1000	90/81	680
	K7805-1000R3(L)	24 (8-36)	5	1000	93/86	680
		12 (8-27)	-5	-500	86/82	330
	K7809-1000R3(L)	24 (13-36)	9	1000	95/90	680
		K7812-1000R3(L)	24 (16-36)	12	1000	96/93
	12 (8-20)		-12	-300	89/88	330
	K7815-1000R3(L)	24 (20-36)	15	1000	96/94	680
		12 (8-18)	-15	-300	89/89	330

Note:1. For input voltage higher than 30 VDC, a 22μF/50V input capacitor is required.

2. K78xx-1000R3L express bend pins product.

## Input Specifications

Item	Operating Conditions	Min.	Typ.	Max.	Unit
No-load Input Current	Positive output	--	0.1	1	mA
Reverse Polarity Input		Forbidden			
Input Filter		Capacitor filter			

## Output Specifications

Item	Operating Conditions	Min.	Typ.	Max.	Unit	
Output Voltage Accuracy	Full load, input voltage range	K7803-1000R3(L)	--	±2	±4	%
		Others	--	±2	±3	
Line Regulation	Full load, input voltage range	--	±0.2	±0.4		
Load Regulation	Nominal input, 10% -100% load	--	±0.4	±0.6		
Ripple & Noise*	20MHz bandwidth, nominal input, 20% -100% load	--	20	75	mVp-p	
Temperature Drift Coefficient	Operating temperature -40°C ~ +85°C	--	--	±0.03	%/°C	
Transient response deviation	Nominal input,	--	50	300	mV	
Transient recovery time	25%-50%-25%, 50%-75%-50% load step change	--	0.1	1	ms	
Output short circuit protection	Nominal input	Continuous, self-recovery				

Note: \*1. Ripple and noise tested with "parallel cable" method, please refer to *DC-DC Converter Application Notes* for specific operation methods;

\*2. With the load lower than 20%, the maximum ripple and noise of 3.3V/5V output products will be 100mVp-p, 9V/12V/15V output products will be 2%Vo.

General Specifications

Item	Operating Conditions	Min.	Typ.	Max.	Unit	
Operating Temperature	Derating if the temperature $\geq 71^{\circ}\text{C}$ (see Fig. 1)	-40	--	85	°C	
Storage Temperature		-55	--	125		
Pin Welding Resistance Temperature	Welding time: 10s (Max.)	--	--	260		
Storage Humidity	Non-condensing	5	--	95	%RH	
Switching Frequency	Full load, nominal input	K7803-1000R3(L)/K7805-1000R3(L)	420	520	620	KHz
		Others	580	680	780	
MTBF	MIL-HDBK-217F@25°C	2000	--	--	K hours	

Physical Specifications

Casing Material	Black flame-retardant and heat-resistant plastic (UL94 V-0)	
Package Dimensions	K78xx-1000R3	11.50*9.00*17.50 mm
	K78xx-1000R3L	19.00*11.50*9.00 mm
Weight	3.8g (Typ.)	
Cooling Method	Free air convection	

EMC Specifications

EMI	CE	CISPR22/EN55022	CLASS B (see Fig. 4-② for recommended circuit)	
	RE	CISPR22/EN55022	CLASS B (see Fig. 4-② for recommended circuit)	
EMS	ESD	IEC/EN 61000-4-2	Contact $\pm 4\text{KV}$	perf. Criteria B
	RS	IEC/EN 61000-4-3	10V/m	perf. Criteria A
	EFT	IEC/EN 61000-4-4	$\pm 1\text{KV}$ (see Fig. 4-① for recommended circuit)	perf. Criteria B
	Surge	IEC/EN 61000-4-5	line to line $\pm 1\text{KV}$ (see Fig. 4-① for recommended circuit)	perf. Criteria B
	CS	IEC/EN 61000-4-6	3Vr.m.s	perf. Criteria A

Product Characteristic Curve

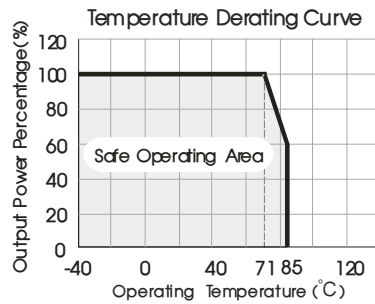
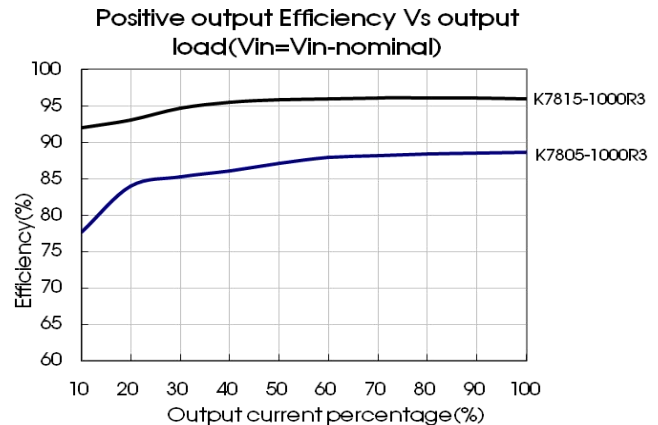
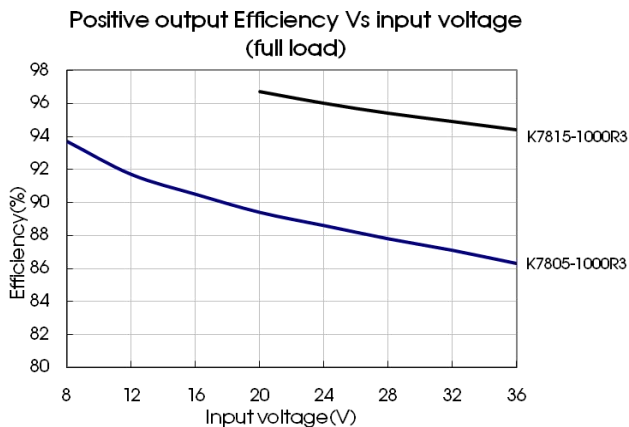
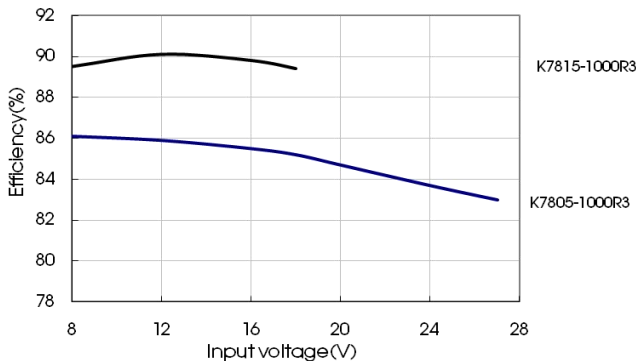

Fig. 1



Negative output Efficiency Vs input voltage (full load)



Negative output Efficiency Vs output load (Vin=Vin-nominal)

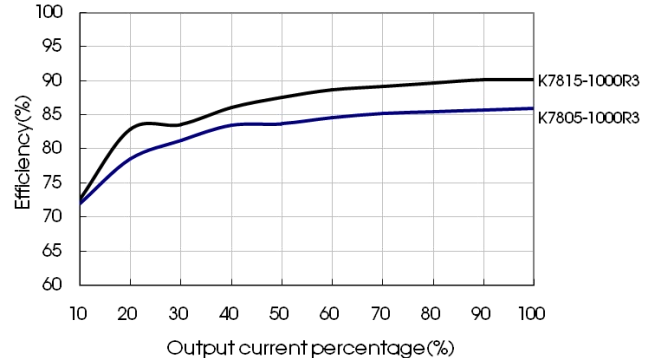

## Design Reference

### 1. Typical application circuit

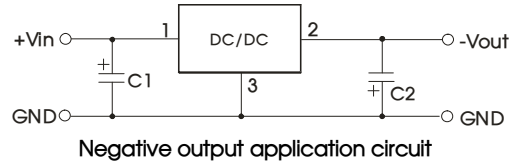
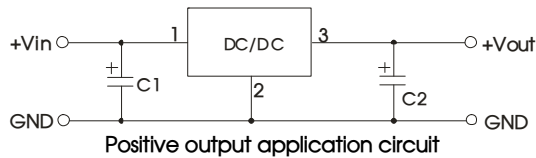

Fig. 2 Typical application circuit

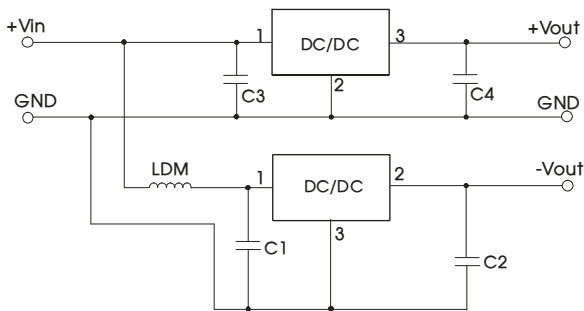

Fig. 3 Positive and Negative output parallelling application circuit

- Note:
- C1 and C2 (C3 and C4) are required and should be connected close to the pin terminal of the module.
  - The capacitance of C1 and C2 (C3 and C4) refer to Sheet 1.
  - To reduce the output ripple furtherly, C2 and C4 can be increased properly if required, tantalum capacitor and aluminum electrolytic capacitor of low ESR may also suffice.
  - When the products used as the circuit like figure 3, an inductor named as LDM up to 10 $\mu$ H is recommended in the circuit to reduce the mutual interference.
  - Cannot be used in parallel to enlarge the power for output and hot swap.

### 2. EMC solution-recommended circuit

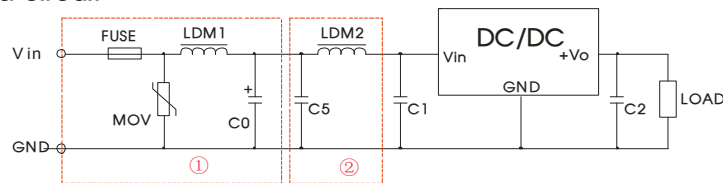

Fig. 4 EMC recommended circuit

Sheet 1

Part No.	C1/C3 (ceramic capacitor)	C2/C4 (ceramic capacitor)
K7803-1000R3(L)	10 $\mu$ F/50V	22 $\mu$ F/10V
K7805-1000R3(L)		22 $\mu$ F/10V
K7809-1000R3(L)		22 $\mu$ F/16V
K7812-1000R3(L)		22 $\mu$ F/25V
K7815-1000R3(L)		22 $\mu$ F/25V

FUSE	MOV	LDM1	C0	C1/C2	C5	LDM2
Selected based on the actual input current from the customer	S20K30	82 $\mu$ H	680 $\mu$ F /50V	Refer to Sheet 1	4.7 $\mu$ F /50V	12 $\mu$ H

Note: Part ① in the Fig. 4 is for EMS test, part ② is for EMI filtering; parts ① and ② can be added based on actual requirement.

3. For more information please find the application notes on [www.mornsun-power.com](http://www.mornsun-power.com)

Dimensions and Recommended Layout

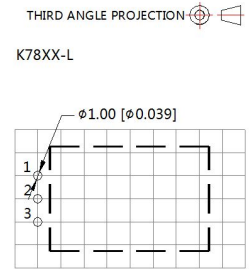
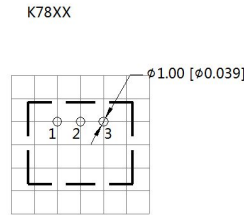
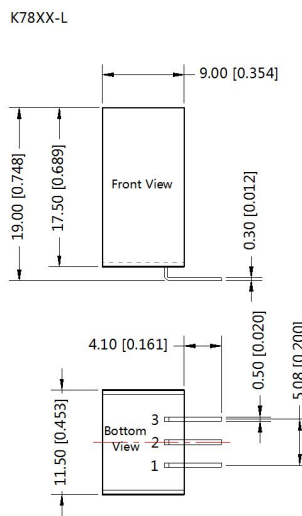
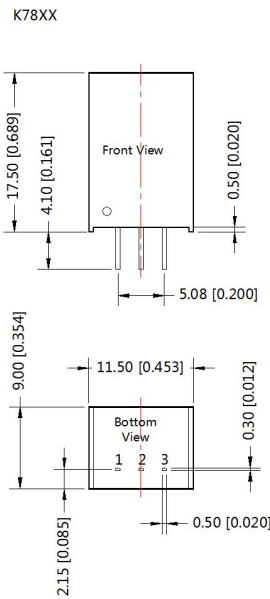

Note : Grid 2.54\*2.54mm

Pin-Out		
Pin	+Output	-Output
1	Vin	Vin
2	GND	-Vo
3	+Vo	GND

Note:  
Unit :mm[inch]  
Pin diameter tolerances :±0.10[±0.004]  
General tolerances:±0.25[±0.010]

Notes:

1. Packing information please refer to Product Packing Information which can be downloaded from [www.mornsun-power.com](http://www.mornsun-power.com). Packing bag number: 58210021(K78xx-1000R3), 58210027(K78xx-1000R3L);
2. The maximum capacitive load offered were tested at input voltage range and full load;
3. Unless otherwise specified, parameters in this datasheet were measured under the conditions of Ta=25 °C , humidity<75% with nominal input voltage and rated output load;
4. All index testing methods in this datasheet are based on our Company's corporate standards;
5. We can provide product customization service, please contact our technicians directly for specific information;
6. Specifications are subject to change without prior notice.

MORNSUN Guangzhou Science & Technology Co., Ltd.

Address: No. 5, Kehui St. 1, Kehui Development Center, Science Ave., Guangzhou Science City, Luogang District, Guangzhou, P. R. China  
Tel: 86-20-38601850-8801 Fax: 86-20-38601272 E-mail: [info@mornsun.cn](mailto:info@mornsun.cn)