

Silicon Controlled Rectifiers

Features

- ◆ Repetitive Peak Off-State Voltage : 600V
- ◆ R.M.S On-State Current ($I_{T(RMS)} = 12\text{ A}$)
- ◆ Low On-State Voltage (1.3V(Typ.)@ I_{TM})
- ◆ Isolation Voltage ($V_{ISO} = 1500\text{V AC}$)

General Description

Standard gate triggering SCR is fully isolated package suitable for the application where requiring high bidirectional blocking voltage capability and also suitable for over voltage protection ,motor control circuit in power tool, inrush current limit circuit and heating control system.

Symbol

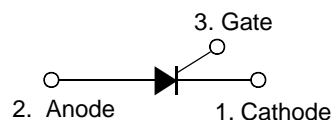

TO-220F

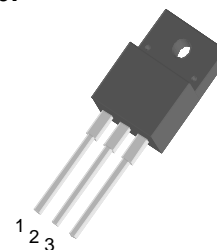

Absolute Maximum Ratings ($T_J = 25^\circ\text{C}$ unless otherwise specified)

Symbol	Parameter	Condition	Ratings	Units
V_{DRM}	Repetitive Peak Off-State Voltage		600	V
$I_{T(AV)}$	Average On-State Current	Half Sine Wave : $T_C = 85^\circ\text{C}$	7.6	A
$I_{T(RMS)}$	R.M.S On-State Current	180° Conduction Angle	12	A
I_{TSM}	Surge On-State Current	1/2 Cycle, 60Hz, Sine Wave Non-Repetitive	132	A
I^2t	I^2t for Fusing	$t = 8.3\text{ms}$	87	A^2s
di/dt	Critical rate of rise of on-state current		50	$\text{A}/\mu\text{s}$
P_{GM}	Forward Peak Gate Power Dissipation		5	W
$P_{G(AV)}$	Forward Average Gate Power Dissipation		0.5	W
I_{FGM}	Forward Peak Gate Current		2	A
V_{RGM}	Reverse Peak Gate Voltage		5.0	V
V_{ISO}	Isolation Breakdown Voltage(R.M.S.)	A.C. 1 minute	1500	V
T_J	Operating Junction Temperature		- 40 ~ 125	$^\circ\text{C}$
T_{STG}	Storage Temperature		- 40 ~ 150	$^\circ\text{C}$

SCF12C60

Electrical Characteristics ($T_C = 25\text{ }^\circ\text{C}$ unless otherwise noted)

Symbol	Items	Conditions	Ratings			Unit
			Min.	Typ.	Max.	
I_{DRM}	Repetitive Peak Off-State Current	$V_{\text{AK}} = V_{\text{DRM}}$ $T_C = 25\text{ }^\circ\text{C}$ $T_C = 125\text{ }^\circ\text{C}$	— —	— —	10 200	μA
V_{TM}	Peak On-State Voltage (1)	$I_{\text{TM}} = 24\text{ A}$ $t_p = 380\mu\text{s}$	—	—	1.6	V
I_{GT}	Gate Trigger Current (2)	$V_{\text{AK}} = 6\text{ V(DC)}$, $R_L = 10\ \Omega$ $T_C = 25\text{ }^\circ\text{C}$	—	—	15	mA
V_{GT}	Gate Trigger Voltage (2)	$V_D = 6\text{ V(DC)}$, $R_L = 10\ \Omega$ $T_C = 25\text{ }^\circ\text{C}$	—	—	1.5	V
V_{GD}	Non-Trigger Gate Voltage (1)	$V_{\text{AK}} = 12\text{ V}$, $R_L = 100\ \Omega$ $T_C = 125\text{ }^\circ\text{C}$	0.2	—	—	V
dv/dt	Critical Rate of Rise Off-State Voltage	Linear slope up to $V_D = V_{\text{DRM}} 67\%$, Gate open $T_J = 125\text{ }^\circ\text{C}$	200	—	—	$\text{V}/\mu\text{s}$
I_{H}	Holding Current	$I_T = 100\text{ mA}$, Gate Open $T_C = 25\text{ }^\circ\text{C}$	—	—	20	mA
$R_{\text{th(j-c)}}$	Thermal Impedance	Junction to case	—	—	3.3	$^\circ\text{C/W}$
$R_{\text{th(j-a)}}$	Thermal Impedance	Junction to Ambient	—	—	60	$^\circ\text{C/W}$

※ Notes :

1. Pulse Width $\leq 1.0\text{ ms}$, Duty cycle $\leq 1\%$
2. R_{GK} Current not Included in measurement.



Fig 1. Gate Characteristics

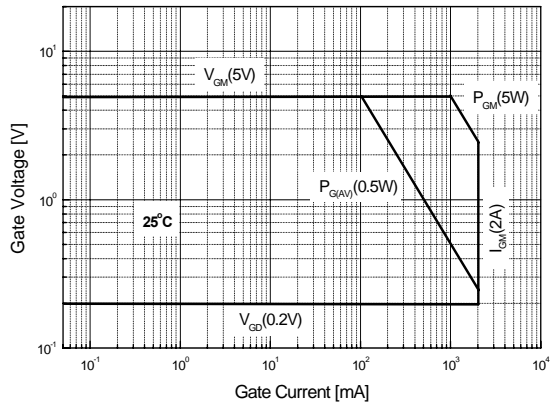

Fig 2. Maximum Case Temperature

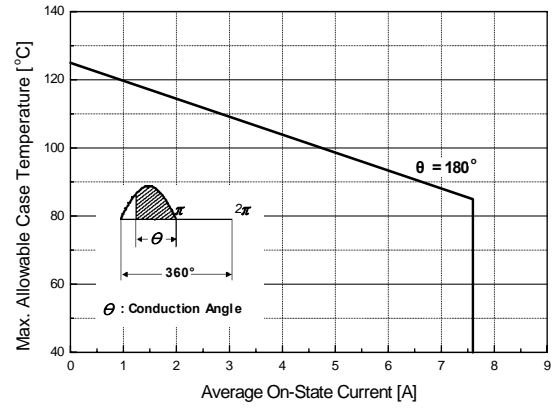

Fig 3. Typical Forward Voltage

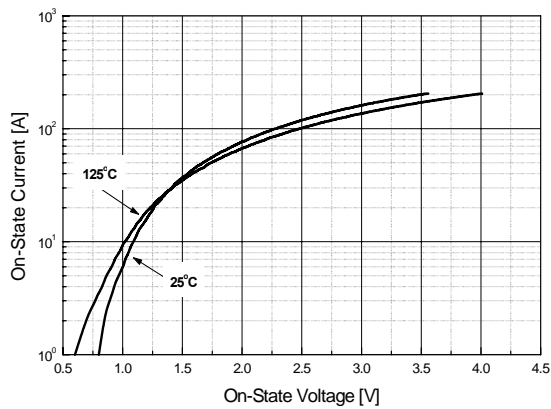

Fig 4. Thermal Response

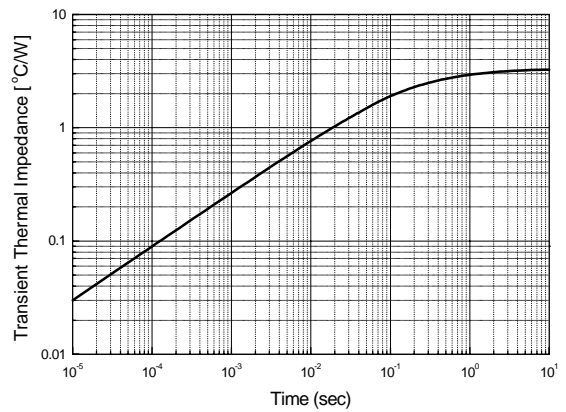

Fig 5. Typical Gate Trigger Voltage vs. Junction Temperature

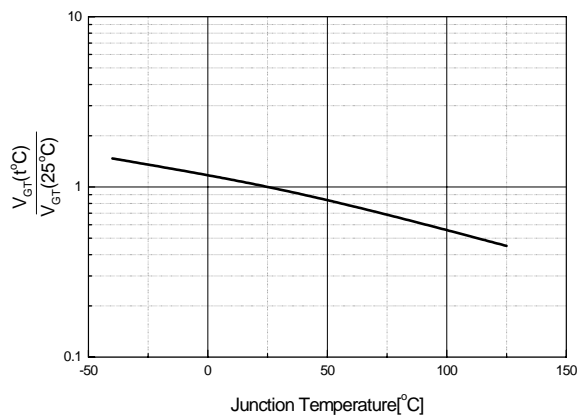
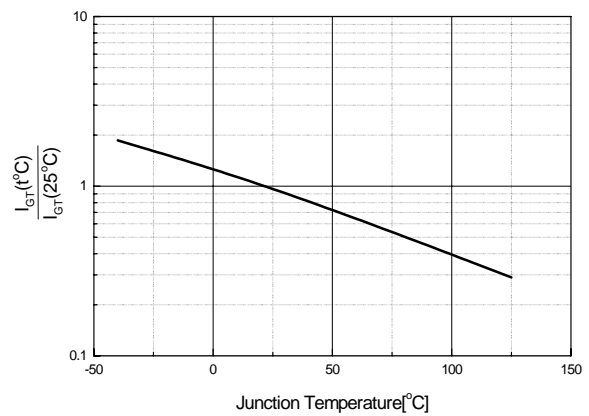

Fig 6. Typical Gate Trigger Current vs. Junction Temperature



SCF12C60

Fig 7. Typical Holding Current

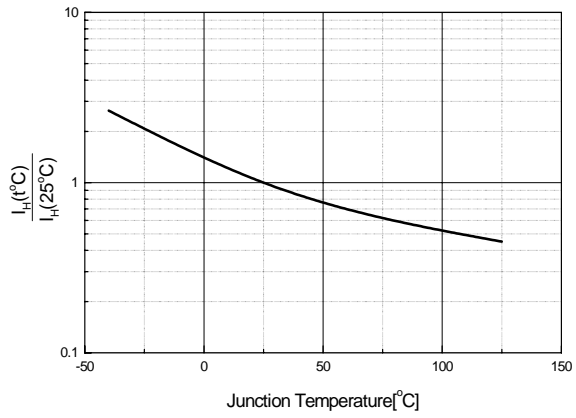
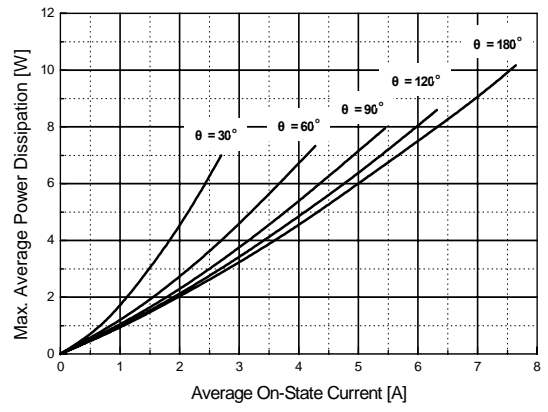

Fig 8. Power Dissipation



SCF12C60

TO-220F Package Dimension

Dim.	mm			Inch		
	Min.	Typ.	Max.	Min.	Typ.	Max.
A	10.4		10.6	0.409		0.417
B	6.18		6.44	0.243		0.254
C	9.55		9.81	0.376		0.386
D	13.47		13.73	0.530		0.540
E	6.05		6.15	0.238		0.242
F	1.26		1.36	0.050		0.054
G	3.17		3.43	0.125		0.135
H	1.87		2.13	0.074		0.084
I	2.57		2.83	0.101		0.111
J		2.54			0.100	
K		5.08			0.200	
L	2.51		2.62	0.099		0.103
M	1.25		1.55	0.049		0.061
N	0.45		0.63	0.018		0.025
O	0.6		1.0	0.024		0.039
ϕ		3.7			0.146	
$\phi 1$		3.2			0.126	
$\phi 2$		1.5			0.059	

