

Kingbright®

T-1(3mm) BI-POLAR AND BI-COLOR INDICATOR LAMPS

L-937 SERIES

Features

- LOW POWER CONSUMPTION.
- I.C. COMPATIBLE.
- HIGH EFFICIENCY RED, GREEN AND YELLOW ARE AVAILABLE.
- LONG LIFE - SOLID STATE RELIABILITY.

Description

The Green source color devices are made with Gallium Phosphide Green Light Emitting Diode.

The High Efficiency Red source color devices are made with Gallium Arsenide Phosphide on Gallium Phosphide Orange Light Emitting Diode.

The Yellow source color devices are made with Gallium Arsenide Phosphide on Gallium Phosphide Yellow Light Emitting Diode.

Package Dimensions

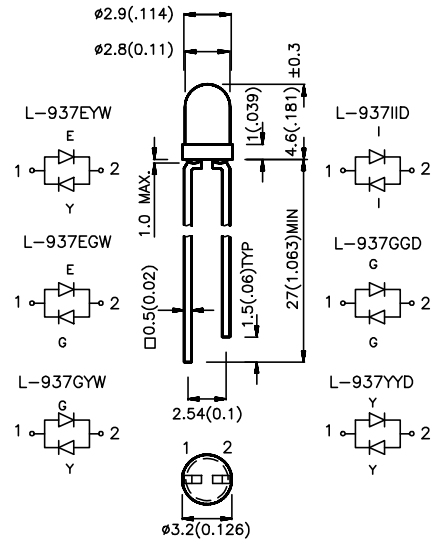

Notes:

1. All dimensions are in millimeters (inches).
2. Tolerance is $\pm 0.25(0.01)$ unless otherwise noted.
3. Lead spacing is measured where the lead emerge package.
4. Specifications are subjected to change without notice.

Selection Guide

Part No.	Dice	Lens Type	Iv (mcd) @ 20 mA		Viewing Angle
			Min.	5Max.	
L-937IID	HIGH EFFICIENCY RED (GaAsP/GaP)	RED DIFFUSED	8	40	60°
	HIGH EFFICIENCY RED (GaAsP/GaP)		8	40	
L-937GGD	GREEN (GaP)	GREEN DIFFUSED	5	20	60°
	GREEN (GaP)		5	20	
L-937YYD	YELLOW (GaAsP/GaP)	YELLOW DIFFUSED	5	20	60°
	YELLOW (GaAsP/GaP)		5	20	
L-937EGW	HIGH EFFICIENCY RED (GaAsP/GaP)	WHITE DIFFUSED	8	40	60°
	GREEN (GaP)		5	20	
L-937EYW	HIGH EFFICIENCY RED (GaAsP/GaP)	WHITE DIFFUSED	8	40	60°
	YELLOW (GaAsP/GaP)		5	20	
L-937GYW	GREEN (GaP)	WHITE DIFFUSED	5	20	60°
	YELLOW (GaAsP/GaP)		5	20	

Note:

1. $\theta_{1/2}$ is the angle from optical centerline where the luminous intensity is 1/2 the optical centerline value.

Electrical / Optical Characteristics at T_A=25°C

Symbol	Parameter	Device	Typ.	Max.	Units	Test Conditions
λ_{peak}	Peak Wavelength	High Efficiency Red Green Yellow	625 565 590		nm	IF=20mA
$\Delta\lambda_{1/2}$	Spectral Line Halfwidth	High Efficiency Red Green Yellow	45 30 35		nm	IF=20mA
C	Capacitance	High Efficiency Red Green Yellow	12 45 10		pF	VF=0V;f=1MHz
V _F	Forward Voltage	High Efficiency Red Green Yellow	2.0 2.2 2.1	2.5 2.5 2.5	V	IF=20mA
I _R	Reverse Current	All	10		uA	VR = 5V

Absolute Maximum Ratings at T_A=25°C

Parameter	High Efficiency Red	Green	Yellow	Units
Power dissipation	105	105	105	mW
DC Forward Current	30	25	30	mA
Peak Forward Current [1]	150	150	150	mA
Reverse Voltage	5	5	5	V
Operating/Storage Temperature	-40 °C To +85 °C			
Lead Soldering Temperature [2]	260 °C For 5 Seconds			

Notes:

- 1/10 Duty Cycle, 0.1ms Pulse Width.
- 4mm below package base.

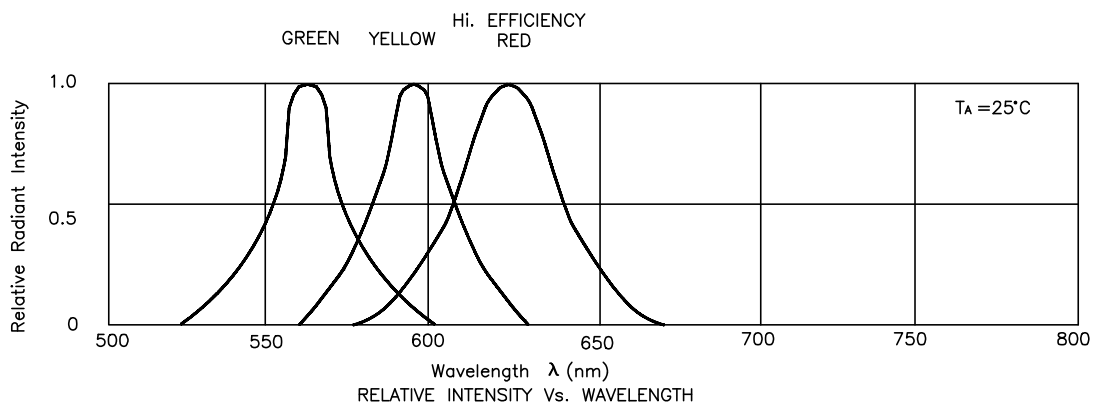

High Efficiency Red L-937IID

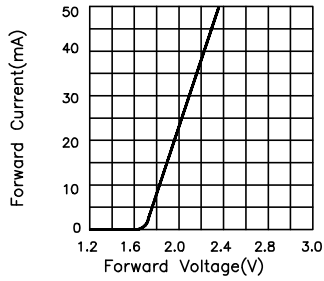

FORWARD CURRENT Vs. FORWARD VOLTAGE

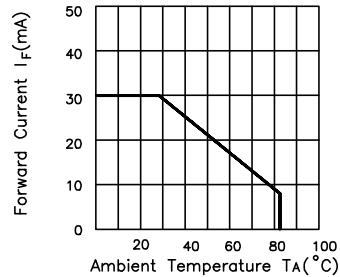

FORWARD CURRENT DERATING CURVE

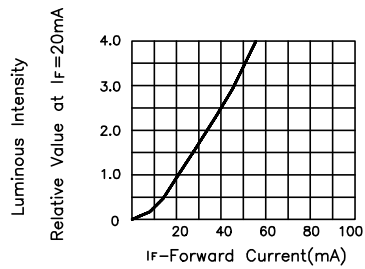

LUMINOUS INTENSITY Vs. FORWARD CURRENT

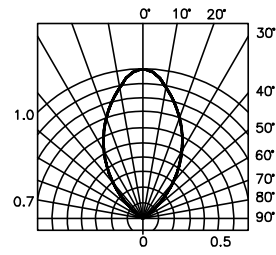

SPATIAL DISTRIBUTION

Green L-937GGD

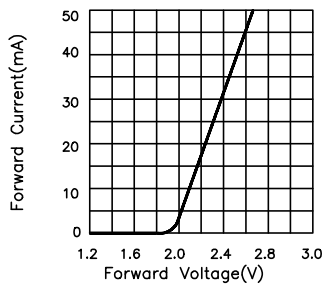

FORWARD CURRENT Vs. FORWARD VOLTAGE

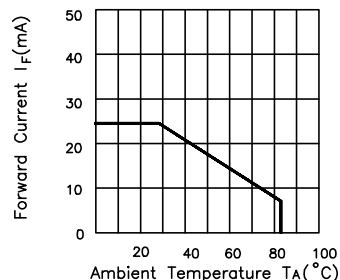

FORWARD CURRENT DERATING CURVE

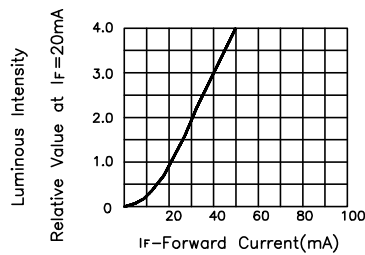

LUMINOUS INTENSITY Vs. FORWARD CURRENT

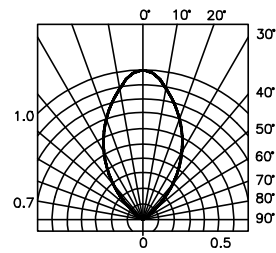

SPATIAL DISTRIBUTION

Yellow L-937YYD

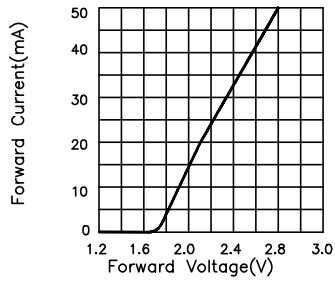

FORWARD CURRENT Vs. FORWARD VOLTAGE

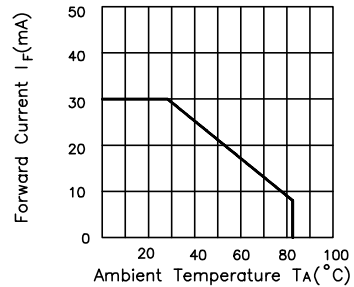

FORWARD CURRENT DERATING CURVE

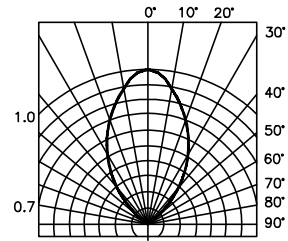
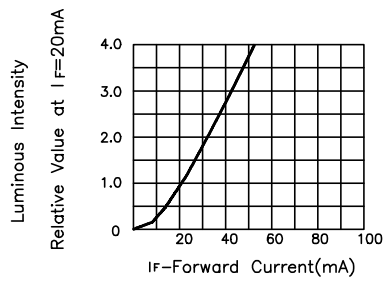

SPATIAL DISTRIBUTION

High Efficiency Red / Green L-937EGW

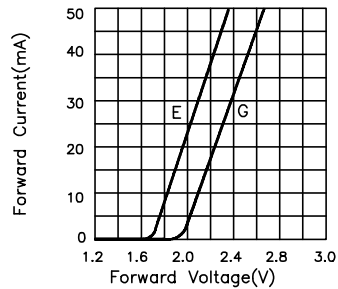

FORWARD CURRENT Vs. FORWARD VOLTAGE

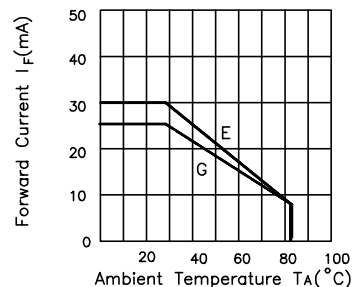

FORWARD CURRENT DERATING CURVE

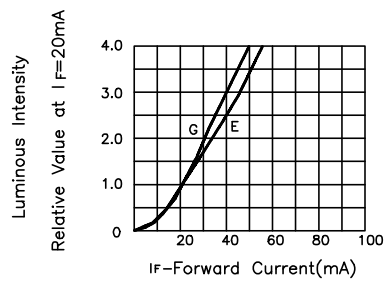

LUMINOUS INTENSITY Vs. FORWARD CURRENT

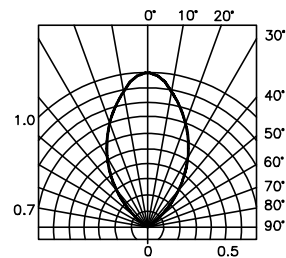

SPATIAL DISTRIBUTION

High Efficiency Red / Yellow L-937EYW

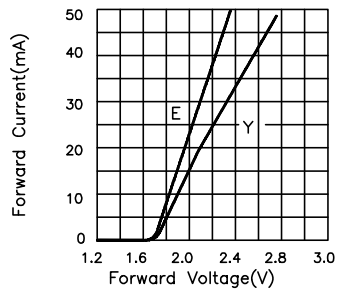

FORWARD CURRENT Vs. FORWARD VOLTAGE

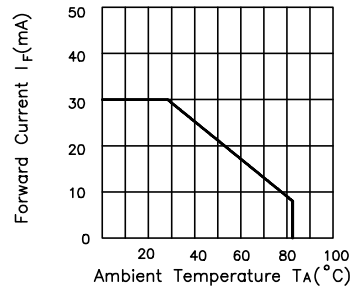

FORWARD CURRENT DERATING CURVE

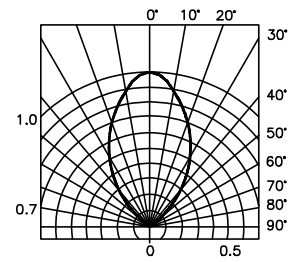
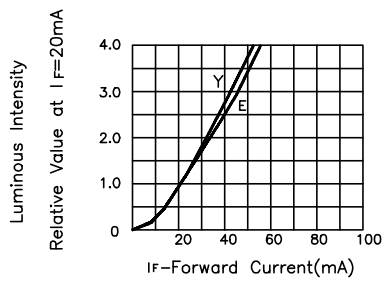

SPATIAL DISTRIBUTION

Green / Yellow L-937GYW

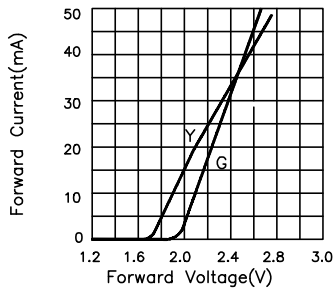

FORWARD CURRENT Vs. FORWARD VOLTAGE

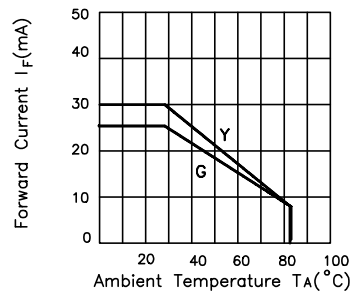

FORWARD CURRENT DERATING CURVE

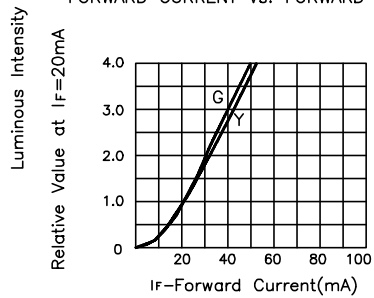

LUMINOUS INTENSITY Vs. FORWARD CURRENT

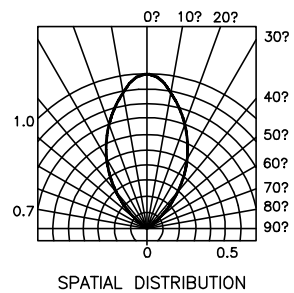

SPATIAL DISTRIBUTION