



KFV
KGV

Einbaukupplung nach IEC 60130-9, IP 40, mit Schraubverschluss und Lötanschlüssen

KFV: für Frontmontage

KGV: für Rückseitenmontage

1. Temperaturbereich -40 °C/+85 °C

2. Werkstoffe

Kontaktträger
 Kontaktbuchse 3- bis 8-polig
 Kontaktbuchse 12-polig
 Gehäuse
 Ringmutter

PA GF
 CuZn, versilbert und flashvergoldet
 CuZn, unternickelt und vergoldet
 Zn-Druckguss, vernickelt
 CuZn, vernickelt

3. Mechanische Daten

Steckkraft/Kontakt 3- bis 8-polig¹ < 5,0 N
 Steckkraft/Kontakt 12-polig² < 5,0 N
 Ziehkraft/Kontakt 3- bis 8-polig¹ > 1,2 N
 Ziehkraft/Kontakt 12-polig² > 0,9 N
 Kontaktierung mit Schutzart³ Steckern 033098, 033099, SV, WSV IP 40

Weiteres siehe Tabelle

4. Elektrische Daten

Durchgangswiderstand ≤ 5 mΩ

Weiteres siehe Tabelle

¹ gemessen mit einem polierten Stahlstift, Nennmaß 1,5 mm
² gemessen mit einem polierten Stahlstift, Nennmaß 1,0 mm
³ nach DIN EN 60529,
 nur in verschraubtem Zustand mit einem dazugehörigen Gegenstück
⁴ nach VDE 0110/IEC 60664

KFV

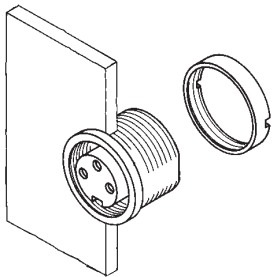

KGV

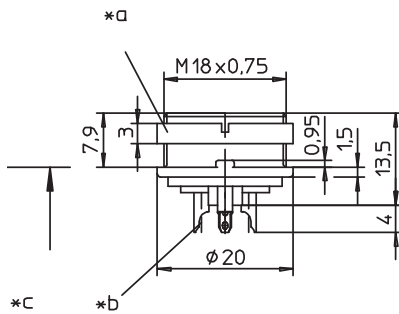
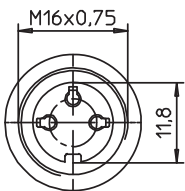
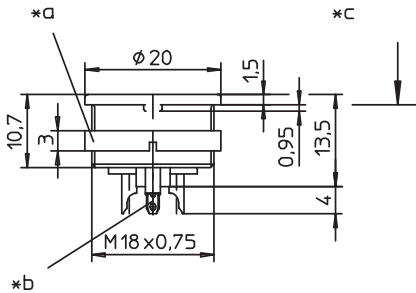
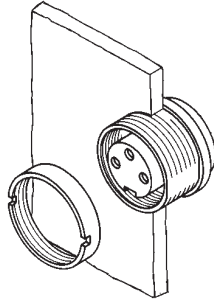

*a Mutter lose beigelegt
 nut enclosed separately
 écrou ajouté séparément

*b Lötkelch
 bell-shaped solder terminal
 plot à souder en forme de coupe

*c Montagerichtung
 mounting direction
 direction de montage

*d Einbauöffnung
 port
 ouverture d'emplacement

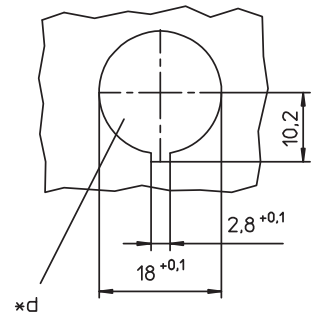

Polbilder, von der Lötseite gesehen
 Pin configurations, solder side view
 Schémas de raccordement, vus du côté à souder

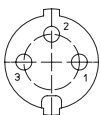

KFV 30
 KGV 30

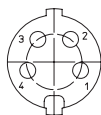

KFV 40
 KGV 40

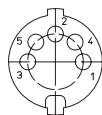

KFV 50
 KGV 50

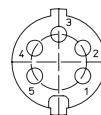

KFV 50/6
 KGV 50/6

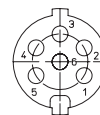

KFV 60
 KGV 60

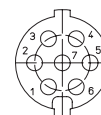

KFV 70
 KGV 70

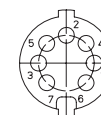

KFV 71
 KGV 71

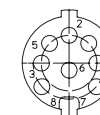

KFV 80
 KGV 80

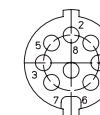

KFV 81
 KGV 81

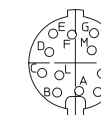

KFV 120
 KGV 120

KFV KGV	
Chassis socket acc. to IEC 60130-9, IP 40, with threaded joint and solder terminals KFV: for front mounting KGV: for rear mounting	
1. Temperature range	-40 °C/+85 °C
2. Materials	Insulating body PA GF Contact bush 3 to 8 poles CuZn, silvered and flash gilded Contact bush 12 poles CuZn, pre-nickel and gilded Housing Zn diecast, nickleed Ring nut CuZn, nickleed
3. Mechanical data	Insertion force/contact 3–8 poles ¹ < 5.0 N Insertion force/contact 12 poles ² < 5.0 N Withdrawal force/contact 3–8 poles ¹ > 1.2 N Withdrawal force/contact 12 poles ² > 0.9 N Mating with plugs 033098, 033099, SV, WSV Protection ³ IP 40 For further information see table
4. Electrical data	Contact resistance ≤ 5 mΩ For further information see table
¹ measured with a polished steel pin, nominal thickness 1.5 mm ² measured with a polished steel pin, nominal thickness 1.0 mm ³ according to DIN EN 60529, only in locked position with a proper counterpart ⁴ according to VDE 0110/IEC 60664	

KFV KGV	
Embase femelle suivant CEI 60130-9, IP 40, avec verrouillage à vis et connexion par soudure KFV: pour montage de front KGV: pour montage par derrière	
1. Température d'utilisation	-40 °C/+85 °C
2. Matériaux	Corps isolant PA GF Prise de contact 3 à 8 pôles CuZn, argenté et doré flash Prise de contact 12 pôles CuZn, sous-nickelé et doré Boîtier Zn moulé sous pression, nickelé Écrou à anneau CuZn, nickelé
3. Caractéristiques mécaniques	Force d'insertion/contact 3–8 pôles ¹ < 5,0 N Force d'insertion/contact pôles ² < 5,0 N Force de séparation/contact 3–8 pôles ¹ > 1,2 N Force de séparation/contact 12 pôles ² > 0,9 N Raccordement avec connecteurs mâles 033098, 033099, SV, WSV Protection ³ IP 40 Pour plus de détails, voir tableau
4. Caractéristiques électriques	Résistance de contact ≤ 5 mΩ Pour plus de détails, voir tableau
¹ mesurée avec une tige d'acier poli, épaisseur nominale 1,5 mm ² mesurée avec une tige d'acier poli, épaisseur nominale 1,0 mm ³ suivant DIN EN 60529, uniquement à l'état verrouillé avec un propre pendant ⁴ suivant VDE 0110/CEI 60664	

Bestellbezeichnung Designation Désignation		Polzahl Poles Pôles	Verpackungseinheit (VE) Package unit (PU) Unité d'emballage (UE)	Anschlussquerschnitt Wire section Section de racc. de fil	Bemessungsstrom Rated current Courant assigné	Bemessungsspannung² Rated voltage² Tension assignée²	Prüfspannung Test voltage Tension d'essai	Isolationswiderstand Insulation resistance Résistance d'isolement	Kontaktkapazität Contact capacitance Capacité de contact
				mm²	A	V AC	kV AC eff.	Ω	pF
KFV 30	KGV 30	3	50	0,75	5	250	2	10¹³	~ 2
KFV 40	KGV 40	4	50	0,75	5	250	2	10¹³	~ 2
KFV 50	KGV 50	5	50	0,75	5	60	1	10¹²	~ 3
KFV 50/6	KGV 50/6	5	50	0,75	5	250	2	10¹³	~ 2
KFV 60	KGV 60	6	50	0,75	5	250	2	10¹³	~ 2
KFV 70	KGV 70	7	50	0,75	5	250	2	10¹³	~ 2
KFV 71	KGV 71	7	50	0,75	5	60	1	10¹²	~ 3
KFV 80	KGV 80	8	50	0,75	5	60	1	10¹²	~ 3
KFV 81	KGV 81	8	50	0,75	5	60	1	10¹²	~ 3
KFV 120	KGV 120	12	50	0,25	3	60	1	10¹²	~ 3

Verpackung: im Karton
 Packaging: in a cardboard box
 Emballage: dans un carton