

OPR120-12 Data Sheet

12V **OPR** Deep Cycle Rechargeable AGM / GEL Hybrid VRLA **Solar Battery**

General Features

- High Corrosion Resistant Performance: Pb-Ca multi-alloy grid
- Patented Silicate Compound Electrolyte
- Superior Charge Acceptance
- Outstanding High and Low Temperature Performance
- Optimised Capability of instant High-current Discharging
- Excellent Deep Discharge Cycle Life
- Design Life is 12 Years

Applications

- | | |
|----------------------|-------------------------|
| Telecommunications | Emergency Lighting |
| Process Control | Streetlights |
| Power Stations | Fire & Security Systems |
| Solar & Wind | Cell Towers |
| UPS | Hospitals |
| Railway Systems | Banks |
| Backup Power Systems | Computer Centres |

Dimensions and Weight

Length	330mm±1.5mm
Width	174mm±1.5mm
Height	216mm±1.5mm
Total Height	221mm±1.5mm
Weight	30.8kg

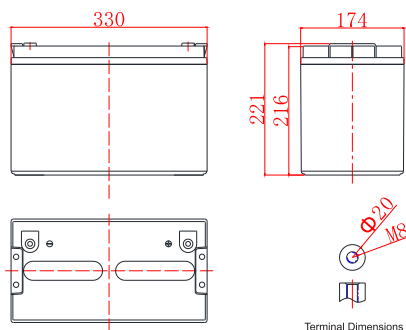

Product Specification

Nominal Voltage	12V
Rated Capacity:	
10 Hour Rate (10.0A to 10.8V)	100Ah
3 Hour Rate (27.0A to 10.8V)	81Ah
1 Hour Rate (62.0A to 10.5V)	62Ah
Internal Resistance	About 4.2mΩ
Self-discharge Rate:	3%/month (25°C)
Operating Temperature Range:	
Discharge	-40°C~60°C
Charge	-40°C~60°C
Storage	-40°C~50°C
Charging Methods	
Floating Use	13.5V~13.8V (25°C)
Cycling Use	14.4V~15.0V (25°C)
Max Charge Current	25.0A

Constant Current Discharge Characteristics Unit: A (25°C,77°F)

FV/Time	5M	15M	30M	1h	2h	3h	5h	8h	10h	20h
1.60V	352	189	115	67.3	38.6	28.0	18.8	12.4	10.4	5.46
1.65V	342	184	113	66.9	38.4	27.7	18.6	12.3	10.3	5.43
1.70V	328	180	111	66.4	38.1	27.3	18.4	12.2	10.2	5.40
1.75V	302	174	110	65.5	37.5	27.0	18.2	12.1	10.1	5.38
1.80V	270	162	105	63.8	36.8	26.9	17.7	12.0	10.0	5.35
1.85V	241	144	96.2	59.1	35.0	25.3	16.9	11.5	9.70	5.26

Constant Power Discharge Characteristics Unit: W/cell (25°C,77°F)

FV/Time	5M	15M	30M	1h	2h	3h	5h	8h	10h	20h
1.60V	603	340	213	130	75	54	36.4	24.3	20.0	10.8
1.65V	580	334	211	129	74	54	36.2	24.1	19.8	10.8
1.70V	577	330	211	128	74	53	35.9	24.0	19.6	10.7
1.75V	538	328	210	127	74	53	35.7	23.8	19.4	10.7
1.80V	494	310	205	126	73	53	35.3	23.6	19.2	10.6
1.85V	441	277	188	117	70	50	33.7	22.8	18.9	10.5

OPR120-12 Data Sheet

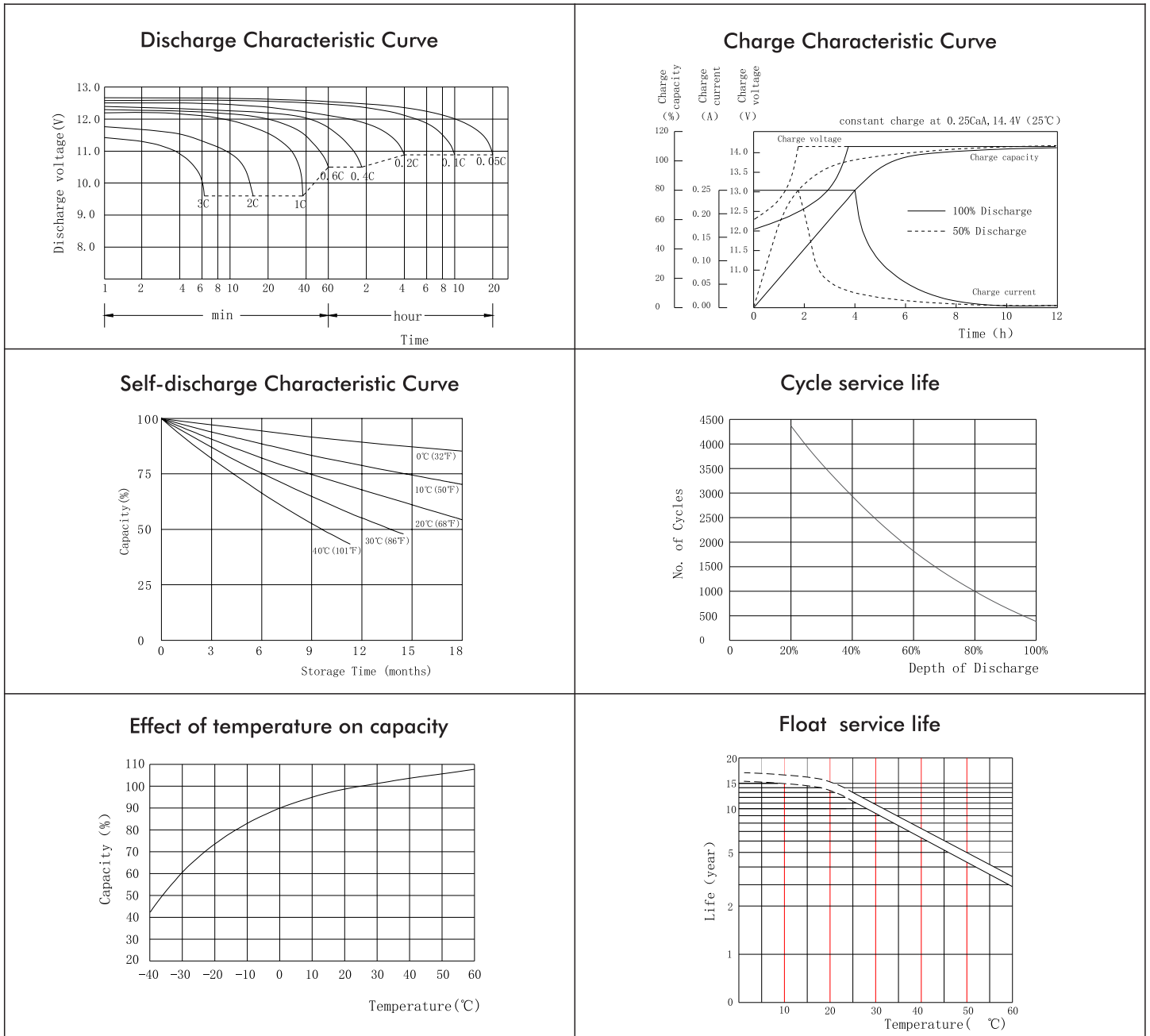

Charging Procedures

Application Type	Charge Voltage			Max charge current (A)
	Temp (°C)	Set point	Temperature compensation	
Cycle Use	25	14.4	-5mV/°C/cell	0,25C
Float Use	25	13.65	-3mV/°C/cell	

Relationship between discharge current & discharge voltage

Discharge rate	1hr	3hr	8hr	10hr
End voltage (V)	10.5	10.8	10.8	10.8
Discharge current (A)	0.55C	0.25C	0.12C	0.1C