

KA1L0380B/KA1L0380RB/KA1M0380RB/ KA1H0380RB

Fairchild Power Switch(SPS)

Features

- Precision fixed operating frequency
- KA1L0380B/KA1L0380RB (50KHz)
- KA1M0380RB (67KHz)
- KA1H0380RB (100KHz)
- Pulse by pulse over current limiting
- Over load protection
- Over voltage protection (Min. 23V)
- Internal thermal shutdown function
- Under voltage lockout
- Internal high voltage sense FET
- Auto restart (KA1L0380RB/KA1M0380RB/KA1H0380RB)

Description

The SPS product family is specially designed for an off-line SMPS with minimal external components. The SPS consist of high voltage power SenseFET and current mode PWM controller IC. PWM controller features integrated fixed oscillator, under voltage lock out, leading edge blanking, optimized gate turn-on/turn-off driver, thermal shut down protection, over voltage protection, temperature compensated precision current sources for loop compensation and fault protection circuit. Compared to discrete MOSFET and controller or RCC switching converter solution, a SPS can reduce total component count, design size, weight and at the same time increase & efficiency, productivity, and system reliability. It has a basic platform well suited for cost effective design in either a flyback converter or a forward converter.

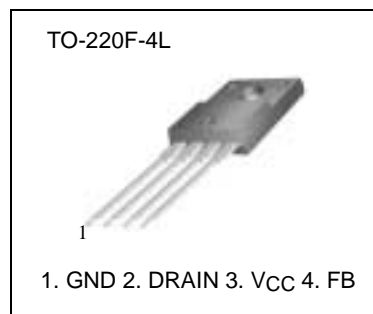

Internal Block Diagram

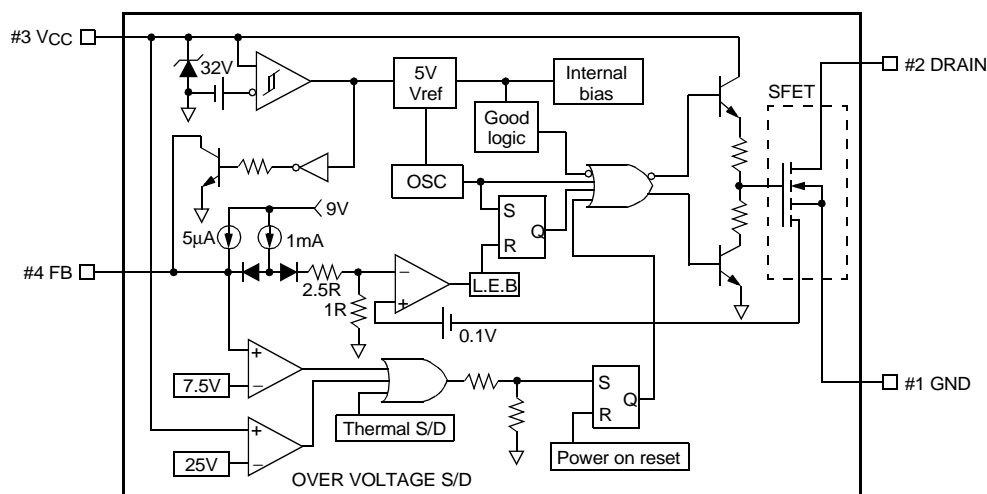

Absolute Maximum Ratings

Parameter	Symbol	Value	Unit
Drain-source (GND) voltage ⁽¹⁾	V _{DSS}	800	V
Drain-Gate voltage (R _{GS} =1MΩ)	V _{DGR}	800	V
Gate-source (GND) voltage	V _{GS}	±30	V
Drain current pulsed ⁽²⁾	I _{DM}	12	ADC
Single pulsed avalanche energy ⁽³⁾	E _{AS}	95	mJ
Avalanche current ⁽⁴⁾	I _{AS}	6	A
Continuous drain current (T _C =25°C)	I _D	3.0	ADC
Continuous drain current (T _C =100°C)	I _D	2.1	ADC
Supply voltage	V _{CC}	30	V
Analog input voltage range	V _{FB}	-0.3 to V _{SD}	V
Total power dissipation	P _D	35	W
	Derating	0.28	W/°C
Operating temperature	T _{OPR}	-25 to +85	°C
Storage temperature	T _{STG}	-55 to +150	°C

Notes:

1. T_j=25°C to 150°C
2. Repetitive rating: Pulse width limited by maximum junction temperature
3. L=51mH, V_{DD}=50V, R_G=25Ω, starting T_j=25°C
4. L=13μH, starting T_j=25°C

Electrical Characteristics (SFET part)

(Ta=25°C unless otherwise specified)

Parameter	Symbol	Condition	Min.	Typ.	Max.	Unit
Drain-source breakdown voltage	BVDSS	VGS=0V, ID=50μA	800	-	-	V
Zero gate voltage drain current	IDSS	VDS=Max., Rating, VGS=0V	-	-	50	μA
		VDS=0.8Max., Rating, VGS=0V, TC=125°C	-	-	200	μA
Static drain-source on resistance ^(Note)	RDS(ON)	VGS=10V, ID=1.5A	-	4.0	5.0	Ω
Forward transconductance ^(Note)	gfs	VDS=15V, ID=1.5A	1.5	2.5	-	S
Input capacitance	Ciss	VGS=0V, VDS=25V, f=1MHz	-	779	-	pF
Output capacitance	Coss		-	75.6	-	
Reverse transfer capacitance	Crss		-	24.9	-	
Turn on delay time	td(on)	VDD=0.5BVDSS, ID=3.0A (MOSFET switching time are essentially independent of operating temperature)	-	40	-	nS
Rise time	tr		-	95	-	
Turn off delay time	td(off)		-	150	-	
Fall time	tf		-	60	-	
Total gate charge (gate-source+gate-drain)	Qg	VGS=10V, ID=3.0A, VDS=0.5BVDSS (MOSFET switching time are essentially independent of operating temperature)	-	-	34	nC
Gate-source charge	Qgs		-	7.2	-	
Gate-drain (Miller) charge	Qgd		-	12.1	-	

Note:

Pulse test: Pulse width ≤ 300μS, duty cycle ≤ 2%

$$S = \frac{1}{R}$$

Electrical Characteristics (CONTROL part)

(Ta=25°C unless otherwise specified)

Parameter	Symbol	Condition	Min.	Typ.	Max.	Unit
REFERENCE SECTION						
Output voltage ⁽¹⁾	Vref	Ta=25°C	4.80	5.00	5.20	V
Temperature Stability ⁽¹⁾⁽²⁾	Vref/ΔT	-25°C≤Ta≤+85°C	-	0.3	0.6	mV/°C
OSCILLATOR SECTION						
Initial accuracy	FOSC	KA1L0380B	45	50	55	kHz
		KA1L0380RB	45	50	55	
		KA1M0380RB	61	67	73	
		KA1H0380RB	90	100	110	
Frequency change with temperature ⁽²⁾	ΔF/ΔT	-25°C≤Ta≤+85°C	-	±5	±10	%
PWM SECTION						
Maximum duty cycle	Dmax	KA1L0380B	74	77	80	%
		KA1L0380RB	74	77	80	
		KA1M0380RB	74	77	80	
		KA1H0380RB	64	67	70	
FEEDBACK SECTION						
Feedback source current	IFB	Ta=25°C, 0V≤Vfb≤3V	0.7	0.9	1.1	mA
Shutdown delay current	I _{delay}	Ta=25°C, 5V≤Vfb≤VSD	4.0	5.0	6.0	μA
OVER CURRENT PROTECTION SECTION						
Over current protection	IL(max)	Max. inductor current	1.89	2.15	2.41	A
UVLO SECTION						
Start threshold voltage	Vth(H)	-	14	15	16	V
Minimum operating voltage	Vth(L)	After turn on	9	10	11	V
TOTAL STANDBY CURRENT SECTION						
Start current	IST	VCC=14V	0.1	0.3	0.45	mA
Operating supply current (control part only)	IOPR	Ta=25°C	6	12	18	mA
VCC zener voltage	VZ	ICC=20mA	30	32.5	35	V
SHUTDOWN SECTION						
Shutdown Feedback voltage	VSD	-	6.9	7.5	8.1	V
Thermal shutdown temperature (Tj) ⁽¹⁾	TSD	-	140	160	-	°C
Over voltage protection voltage	VOVP	-	23	25	28	V

Notes:

1. These parameters, although guaranteed, are not 100% tested in production
2. These parameters, although guaranteed, are tested in EDS (wafer test) process

Typical Performance Characteristics

(These characteristic graphs are normalized at $T_a=25^\circ\text{C}$)

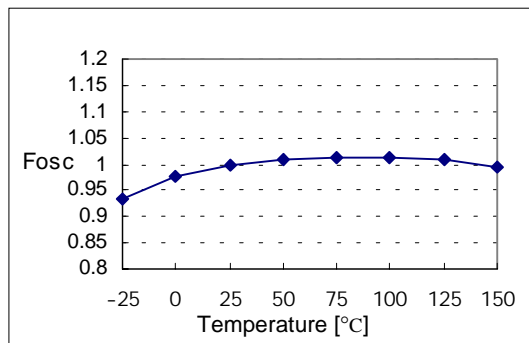

Figure 1. Operating Frequency



Figure 2. Feedback Source Current

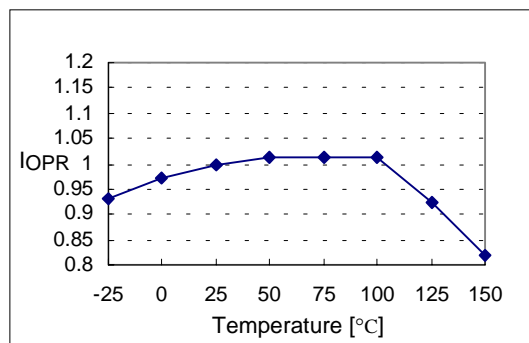

Figure 3. Operating Current

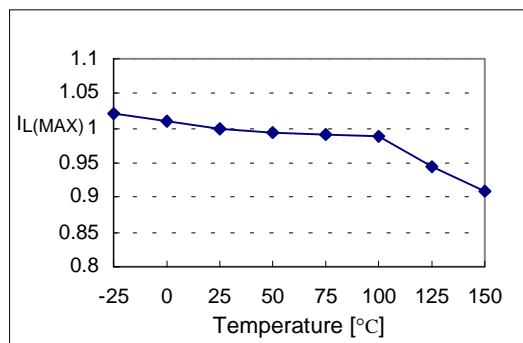

Figure 4. Max. Inductor Current

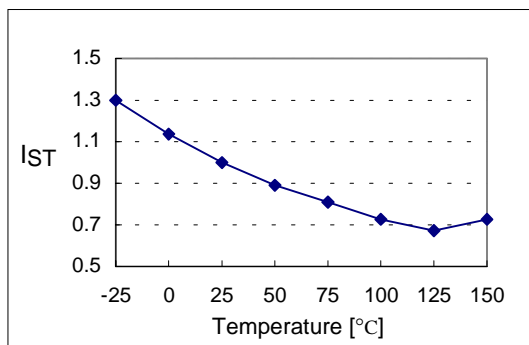

Figure 5. Start up Current



Figure 6. Start Threshold Voltage

Typical Performance Characteristics (Continued)

(These characteristic graphs are normalized at Ta=25°C)



Figure 7. Stop Threshold Voltage



Figure 8. Maximum Duty Cycle



Figure 9. VCC Zener Voltage



Figure 10. Shutdown Feedback Voltage



Figure 11. Shutdown Delay Current



Figure 12. Over Voltage Protection

Typical Performance Characteristics (Continued)

(These characteristic graphs are normalized at $T_a=25^\circ\text{C}$)

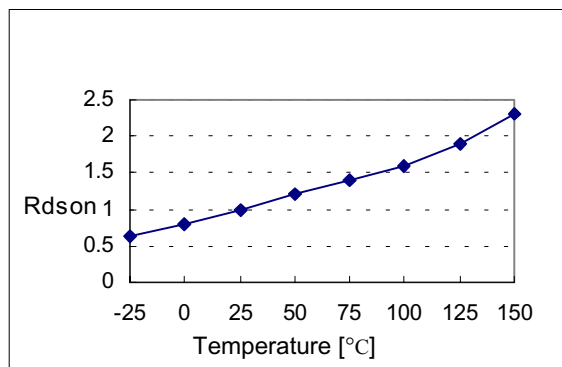
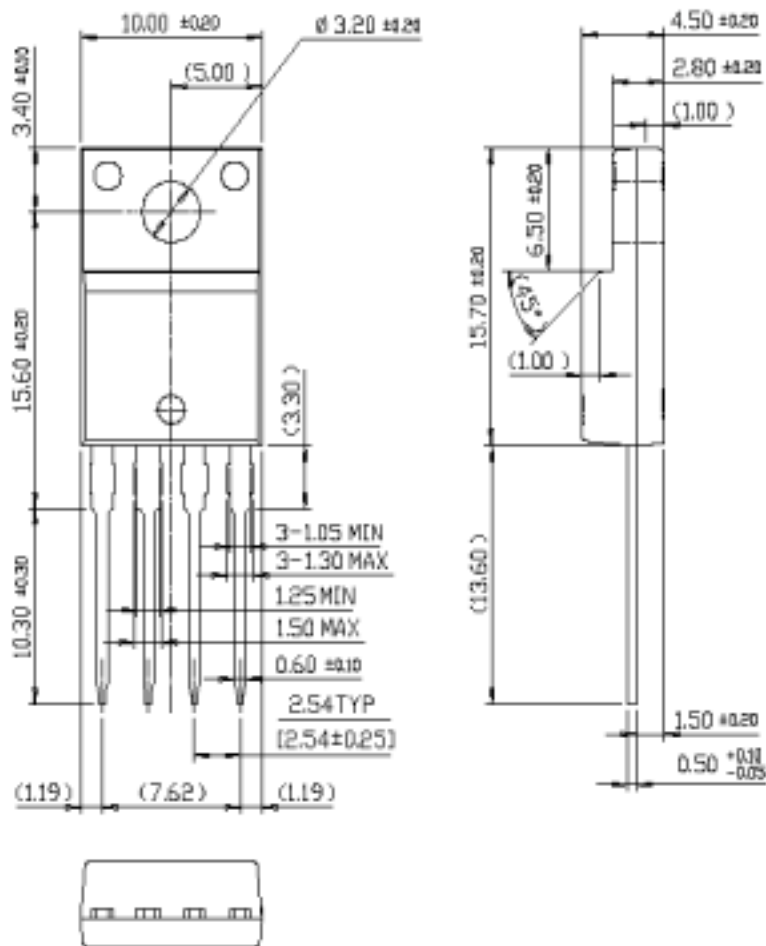

Figure 13. Drain Source Turn-on Resistance

Package Dimensions

TO-220F-4L



www.DataSheet4U.com

Package Dimensions (Continued)

TO-220F-4L (Forming)

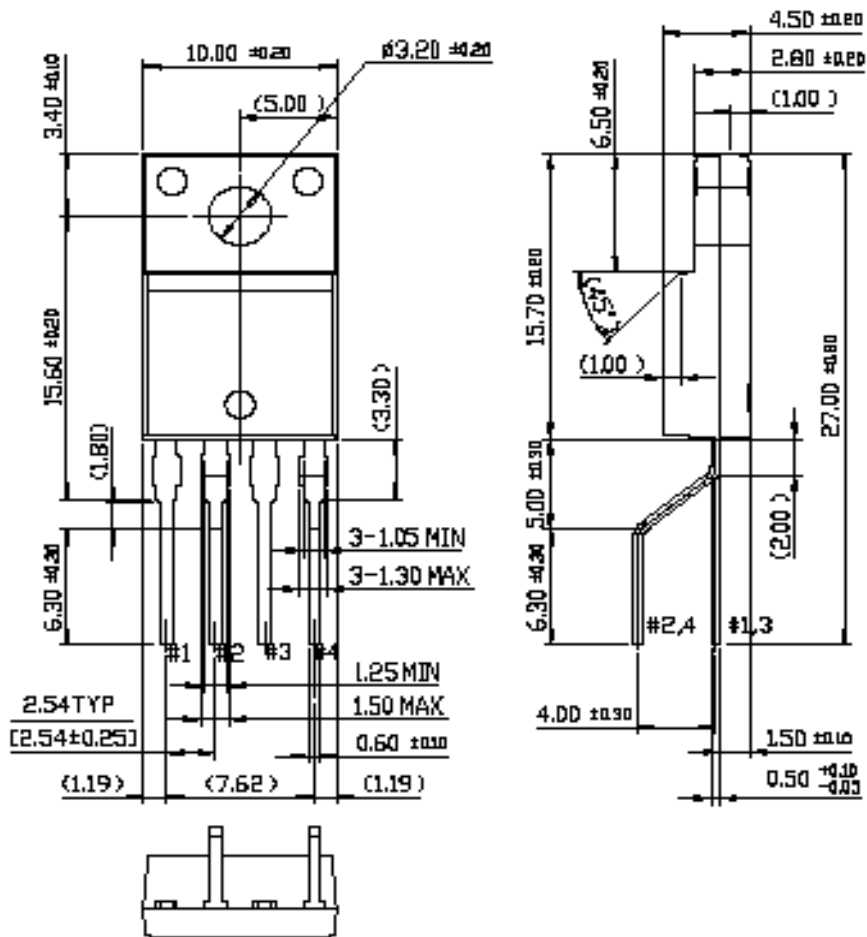

www.DataSheet4U.com

Ordering Information

Product Number	Package	Rating	Fosc
KA1L0380B-TU	TO-220F-4L	800V, 3A	50kHz
KA1L0380B-YDTU	TO-220F-4L(Forming)		
KA1L0380RB-TU	TO-220F-4L	800V, 3A	50kHz
KA1L0380RB-YDTU	TO-220F-4L(Forming)		
KA1M0380RB-TU	TO-220F-4L	800V, 3A	67kHz
KA1M0380RB-YDTU	TO-220F-4L(Forming)		
KA1H0380RB-TU	TO-220F-4L	800V, 3A	100kHz
KA1H0380RB-YDTU	TO-220F-4L(Forming)		

TU : Non Forming Type

YDTU : Forming Type

DISCLAIMER

FAIRCHILD SEMICONDUCTOR RESERVES THE RIGHT TO MAKE CHANGES WITHOUT FURTHER NOTICE TO ANY PRODUCTS HEREIN TO IMPROVE RELIABILITY, FUNCTION OR DESIGN. FAIRCHILD DOES NOT ASSUME ANY LIABILITY ARISING OUT OF THE APPLICATION OR USE OF ANY PRODUCT OR CIRCUIT DESCRIBED HEREIN; NEITHER DOES IT CONVEY ANY LICENSE UNDER ITS PATENT RIGHTS, NOR THE RIGHTS OF OTHERS.

LIFE SUPPORT POLICY

FAIRCHILD'S PRODUCTS ARE NOT AUTHORIZED FOR USE AS CRITICAL COMPONENTS IN LIFE SUPPORT DEVICES OR SYSTEMS WITHOUT THE EXPRESS WRITTEN APPROVAL OF THE PRESIDENT OF FAIRCHILD SEMICONDUCTOR INTERNATIONAL. As used herein:

1. Life support devices or systems are devices or systems which, (a) are intended for surgical implant into the body, or (b) support or sustain life, and (c) whose failure to perform when properly used in accordance with instructions for use provided in the labeling, can be reasonably expected to result in a significant injury of the user.
2. A critical component in any component of a life support device or system whose failure to perform can be reasonably expected to cause the failure of the life support device or system, or to affect its safety or effectiveness.