

Unit:inch(mm)

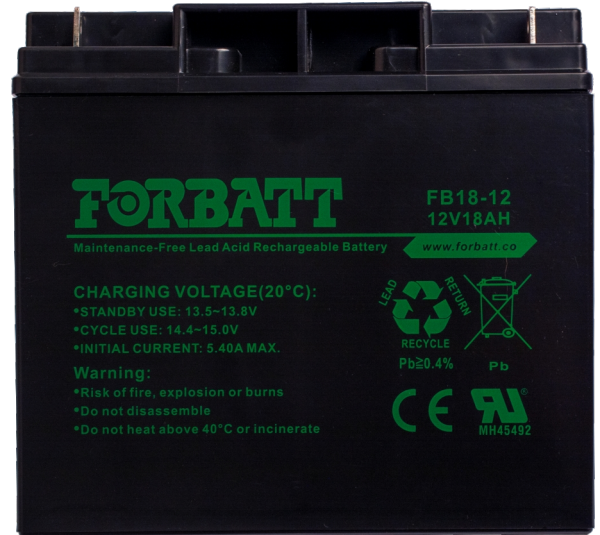

Discharge Current and Discharge Duration Time

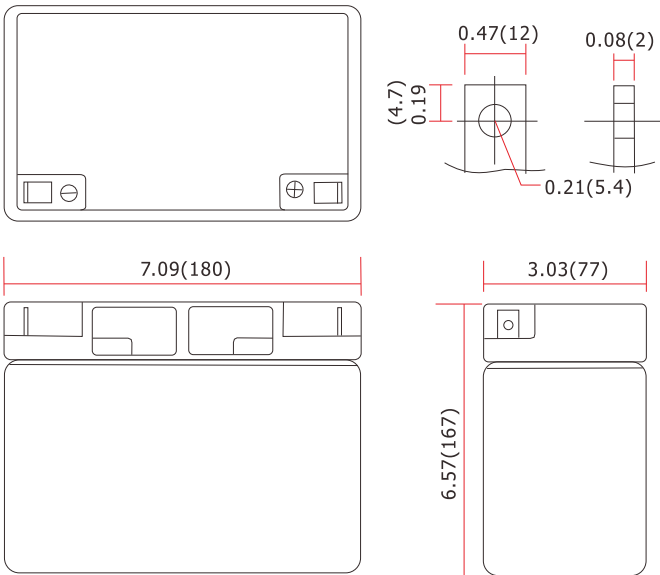
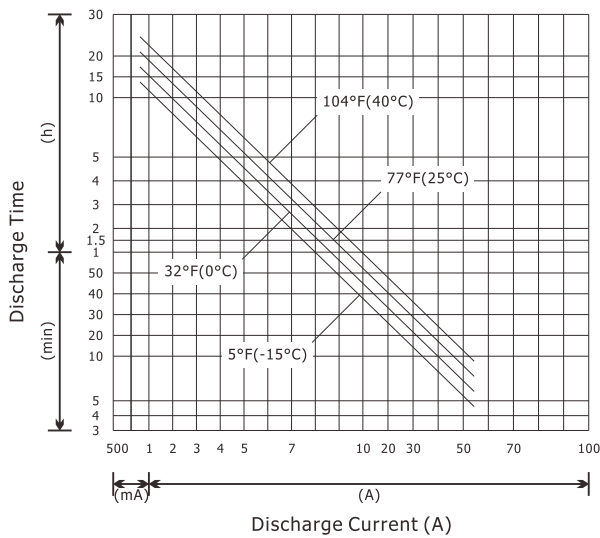

Discharge Curves 77°F(25°C)

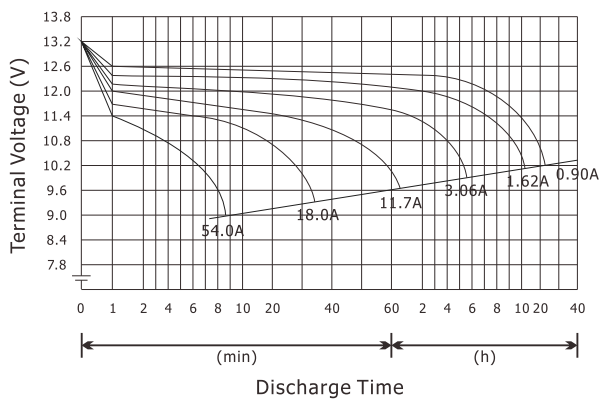

Specification

Nominal Voltage	12V	
Rated Capacity (20hr Rate)	18Ah	
Dimensions	Length	7.09inches (180mm)
	Width	3.03inches (77mm)
	Height	6.57inches (167mm)
	Total Height	6.57inches (167mm)
Weight	Approx. 11.31lbs (5.13kg)	
Characteristics		
Capacity 77°F(25°C)	20hour rate (0.90A)	18.0Ah
	10hour rate (1.62A)	16.2Ah
	5hour rate (3.06A)	15.3Ah
	1hour rate (11.7A)	11.7Ah
Internal Resistance	Full Charged, 77°F(25°C)	15mΩ
Capacity Affected By Temperature (10hr Rate)	104°F(40°C)	102%
	77°F(25°C)	100%
	32°F(0°C)	85%
	5°F(-15°C)	65%
Self-Discharge 77°F(25°C)	Capacity after 3 month storage	90%
	Capacity after 6 month storage	80%
	Capacity after 9 month storage	60%
Charge (Constant Voltage)	Initial Charge Current "LESS" than 5.40A	
	Cycle	14.4-15.0V/77°F(25°C)
	Stand By	13.5-13.8V/77°F(25°C)

**These data are average values obtained from three Charge/Discharge cycles. Note: These are NOT minimum values.

Constant Current Discharge Characteristics Unit: A (25°C / 77°F)

F.V/Time	5MIN	10MIN	15MIN	30MIN	1HR	2HR	3HR	5HR	8HR	10HR	20HR
9.6V	60.2	42.3	32.1	19.8	11.9	6.96	5.08	3.24	2.15	1.78	0.99
10.0V	55.7	39.9	30.6	19.1	11.7	6.82	5.01	3.19	2.11	1.74	0.97
10.2V	53.4	38.7	29.8	18.7	11.6	6.72	4.95	3.17	2.09	1.72	0.95
10.5V	49.1	36.4	28.4	18.1	11.4	6.63	4.86	3.14	2.06	1.71	0.93
10.8V	44.4	33.8	26.7	17.4	11.1	6.47	4.76	3.05	2.01	1.67	0.9
11.1V	38.9	30.3	24.6	16.7	10.9	6.35	4.58	2.99	1.97	1.65	0.86

Constant Power Discharge Characteristics Unit: W (25°C / 77°F)

F.V/Time	5MIN	10MIN	15MIN	30MIN	1HR	2HR	3HR	5HR	8HR	10HR	20HR
9.6V	648	469	371	229	137	79.1	57.8	37.7	24.8	20.3	10.9
10.0V	597	439	349	223	134	77.9	56.4	37.1	24.3	19.9	10.8
10.2V	568	425	339	219	132	77.1	55.7	36.5	24.1	19.7	10.7
10.5V	523	398	321	212	130	75.5	54.6	35.8	23.6	19.4	10.6
10.8V	472	367	301	204	127	73.9	53.2	34.7	22.9	18.8	10.4
11.1V	419	333	282	194	123	71.9	51.8	33.8	22.4	18.3	9.90

Trickle / Float Service Life

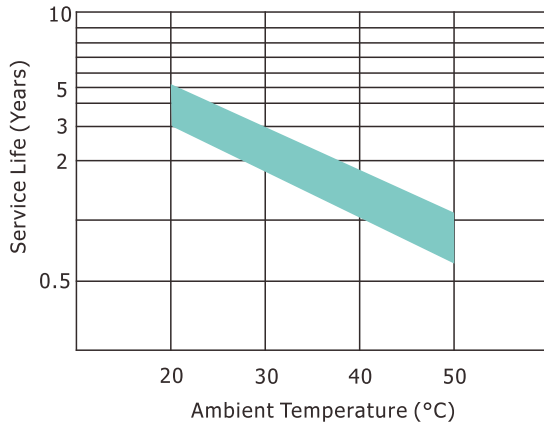

Effect of Temperature on Capacity

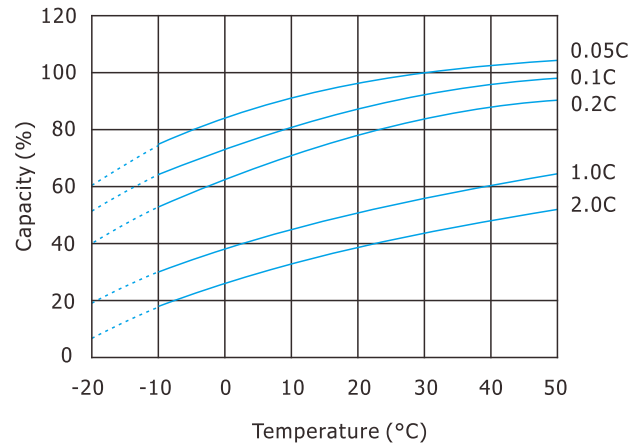

Cycle Service Life (@25°C/77°F)

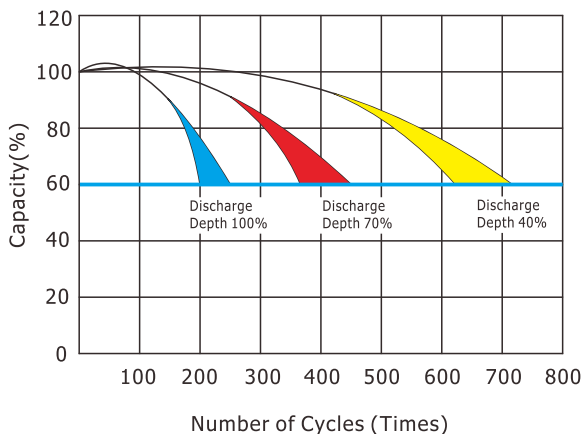

Capacity Retention Characteristic

