

OPR180-12 Data Sheet

12V **OPR** Deep Cycle Rechargeable AGM / GEL Hybrid VRLA **Solar Battery**

General Features

- High Corrosion Resistant Performance: Pb-Ca multi-alloy grid
- Patented Silicate Compound Electrolyte
- Superior Charge Acceptance
- Outstanding High and Low Temperature Performance
- Optimised Capability of instant High-current Discharging
- Excellent Deep Discharge Cycle Life
- Design Life is 12 Years

Applications

- | | |
|----------------------|-------------------------|
| Telecommunications | Emergency Lighting |
| Process Control | Streetlights |
| Power Stations | Fire & Security Systems |
| Solar & Wind | Cell Towers |
| UPS | Hospitals |
| Railway Systems | Banks |
| Backup Power Systems | Computer Centres |

Dimensions and Weight

Length	483mm±1.5mm
Width	170mm±1.5mm
Height	240mm±1.5mm
Total Height	240mm±1.5mm
Weight	45kg

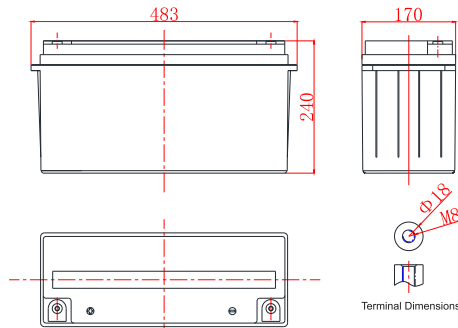

Product Specification

Nominal Voltage	12V
Rated Capacity:	
10 Hour Rate (15.0A to 10.8V)	150Ah
3 Hour Rate (40.0A to 10.8V)	120Ah
1 Hour Rate (90.0A to 10.5V)	90Ah
Internal Resistance	About 3.2mΩ
Self-discharge Rate:	3%/month (25°C)
Operating Temperature Range:	
Discharge	-40°C~60°C
Charge	-40°C~60°C
Storage	-40°C~50°C
Charging Methods	
Floating Use	13.5V~13.8V (25°C)
Cycling Use	14.4V~15.0V (25°C)
Max Charge Current	37.5A

Constant Current Discharge Characteristics Unit: A (25°C,77°F)

FV/Time	5M	15M	30M	1h	2h	3h	5h	8h	10h	20h
1.60V	539	290	176	103	59.1	42.9	28.8	18.8	15.6	8.19
1.65V	523	281	173	102	58.8	42.5	28.5	18.6	15.5	8.15
1.70V	502	275	170	102	58.4	41.9	28.2	18.5	15.3	8.10
1.75V	462	266	169	100	57.5	41.4	27.9	18.3	15.2	8.07
1.80V	414	248	161	97.7	56.4	41.1	27.2	18.2	15.0	8.03
1.85V	369	221	147	90.5	53.6	38.7	25.8	17.4	14.6	7.89

Constant Power Discharge Characteristics Unit: W/cell (25°C,77°F)

FV/Time	5M	15M	30M	1h	2h	3h	5h	8h	10h	20h
1.60V	904	510	319	195	112	81.6	54.6	36.5	30.0	16.2
1.65V	870	501	316	193	111	80.6	54.3	36.2	29.7	16.1
1.70V	865	495	316	192	111	80.1	53.9	36.0	29.4	16.1
1.75V	807	492	314	190	110	79.7	53.6	35.7	29.1	16.0
1.80V	741	466	307	189	110	79.4	53.0	35.4	28.8	15.9
1.85V	662	416	281	175	105	75.5	50.6	34.2	28.4	15.8

OPR180-12

Data Sheet

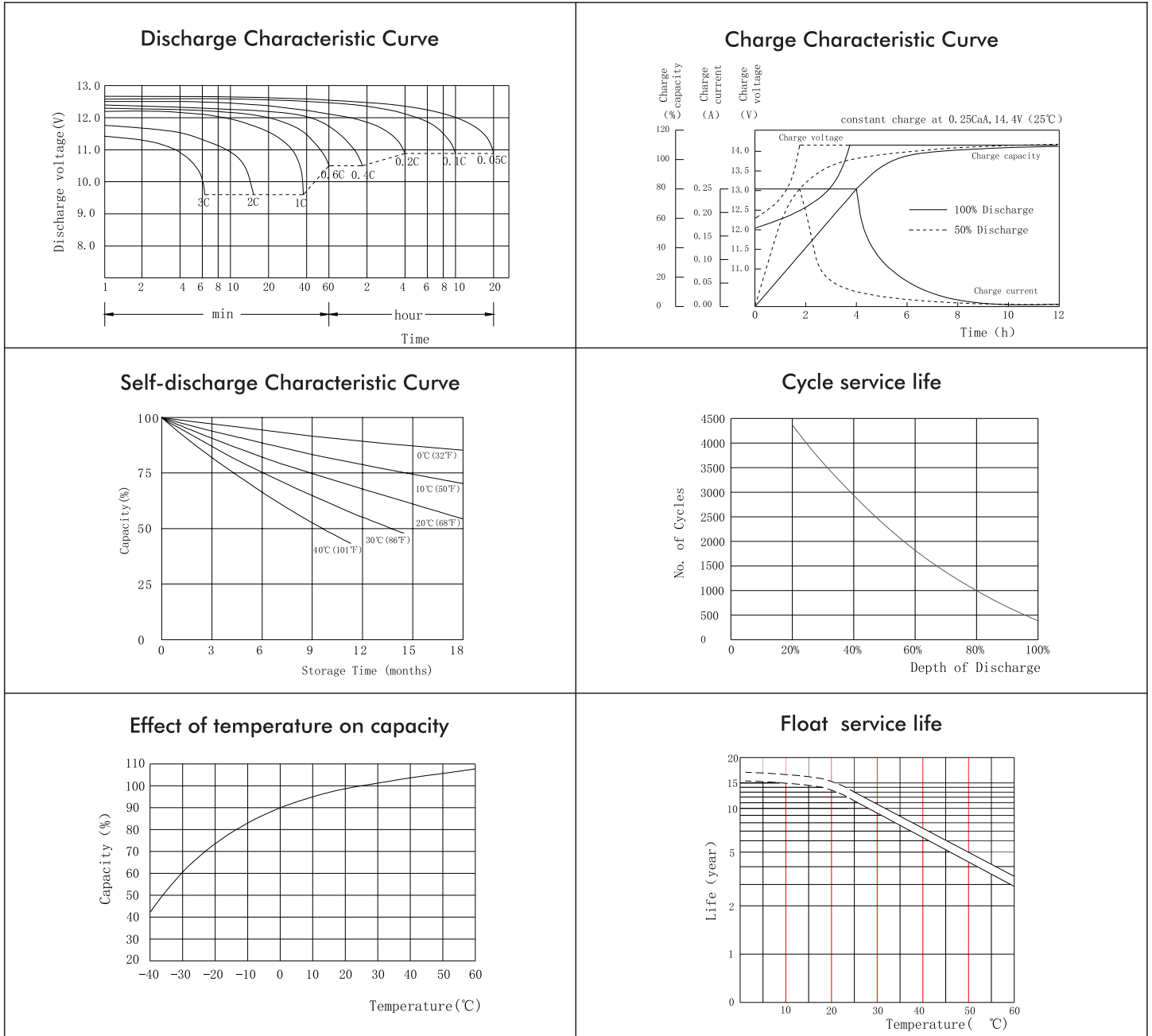

Charging Procedures

Application Type	Charge Voltage			Max charge current (A)
	Temp (°C)	Set point	Temperature compensation	
Cycle Use	25	14.4	-5mV/°C/cell	0,25C
Float Use	25	13.65	-3mV/°C/cell	

Relationship between discharge current & discharge voltage

Discharge rate	1hr	3hr	8hr	10hr
End voltage (V)	10.5	10.8	10.8	10.8
Discharge current (A)	0.55C	0.25C	0.12C	0.1C