

THE DUOLINE SERIES

POE+ Injector and Surge Protection

Features

- Automatically supplies a PoE+ (30 Watts) or PoE (15 Watts) connection to the device.
- Support Gigabit network (1000Base-T)
- Plug-and-Play: No configuration required
- Short Circuit, Over Current and Over Voltage Full Protection
- Reduce installation and network equipment costs

Protects fast ethernet LAN and POE equipment such as hubs, switches and network interface cards from induced lightning and electrostatic discharge.

Compatible with most gigabit IP camera, IP phone, Wireless IP point and other PoE devices.

12-00719

rev0



*Specifications subject to change without prior notice due to continuous improvements

Specifications	
Power Surge Protection	
Nom. Input Voltage	230VAC 50Hz
Output Voltage	24V DC
Output Current	1000mA
Max. Discharge Current	2.5kA L-N, L-E, N-E (8/20us)
Residual Voltage	<900V
Response Time	<25ns
Network/Dataline Surge Protection	
Hi-Pot (Pri to Sec) isolation	1500 Vrms, 1 mA, 60 seconds
Technology Supported	Cat5e
Data Speed Supported	1000 MBit/s
Pairs Protected (Data)	1-2, 3-6, 4-5, 7-8
Pairs Protected (POE+)	1-2, 3-6, 4-5, 7-8
Other	
Indication	LED
Temperature Range	-20°C to +70°C
Standard Compliance	IEC 164-1, 61643-1, IEEE 802.3u/ab/af/at
Lead Length	1x 1.0m RJ11-RJ11 Cable
Dimensions	145x60x40mm
Weight	0.365kg

Dimensions

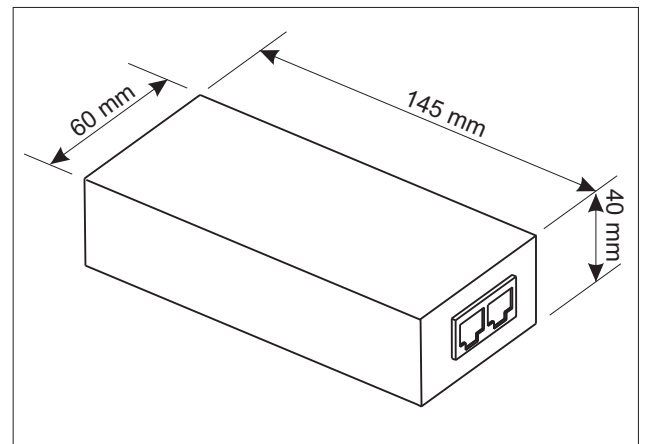

Supplied with:

- RJ45 Cable (Cat5e)
- IEC Power Cord

Designed and Manufactured by:

Clearline Protection Systems (Pty) Ltd

385 Roan Crescent Corporate Park North, Old Pta Road,
Midrand, South Africa
P.O. Box 5985, Halfway House, 1685
Tel: +27 (0) 11 848-1100
Fax: +27 (0) 11 314-3880
E-mail: info@clearline.co.za
www.clearline.co.za

