

EC103xx & SxSx Series

RoHS

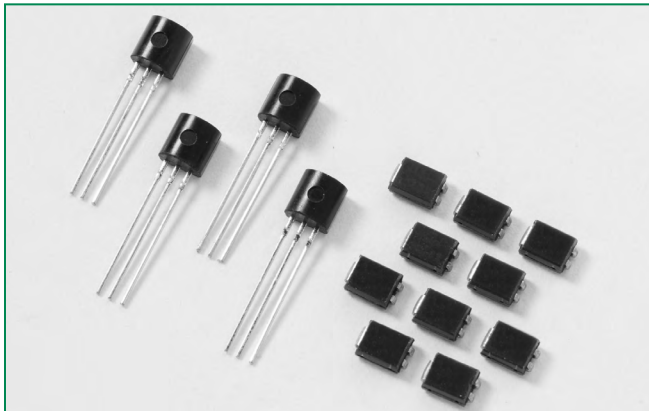

Description

Excellent unidirectional switches for phase control applications such as heating and motor speed controls.

Sensitive gate SCRs are easily triggered with microAmps of current as furnished by sense coils, proximity switches, and microprocessors.

Features & Benefits

- RoHS compliant
- Glass – passivated junctions
- Voltage capability up to 600 V
- Surge capability up to 20 A

Main Features

Symbol	Value	Unit
$I_{T(RMS)}$	0.8	A
V_{DRM}/V_{RRM}	400 to 600	V
I_{GT}	12 to 500	μA

Schematic Symbol



Applications

Typical applications are capacitive discharge systems for strobe lights and gas engine ignition. Also controls for power tools, home/brown goods and white goods appliances.

Additional Information



Datasheet



Resources



Samples

Absolute Maximum Ratings – Sensitive SCRs

Symbol	Parameter	Test Conditions	Value	Unit
$I_{T(RMS)}$	RMS on-state current	$T_c = 75^\circ C$	0.8	A
$I_{T(AV)}$	Average on-state current	$T_c = 75^\circ C$	0.51	A
I_{TSM}	Peak non-repetitive surge current	single half cycle; $f = 50\text{Hz}$; $T_J(\text{initial}) = 25^\circ C$	16	A
		single half cycle; $f = 60\text{Hz}$; $T_J(\text{initial}) = 25^\circ C$	20	
I^2t	I^2t Value for fusing	$t_p = 8.3 \text{ ms}$	1.6	A^2s
di/dt	Critical rate of rise of on-state current	$f = 60 \text{ Hz}$; $T_J = 110^\circ C$	50	$A/\mu s$
I_{GM}	Peak gate current	$T_J = 110^\circ C$	1	A
$P_{G(AV)}$	Average gate power dissipation	$T_J = 110^\circ C$	0.1	W
T_{stg}	Storage temperature range		-40 to 150	$^\circ C$
T_J	Operating junction temperature range		-40 to 110	$^\circ C$

Electrical Characteristics (T_J = 25°C, unless otherwise specified)

Symbol	Test Conditions			Value				Unit
				SxS1 EC103X1	SxS2 EC103X2	SxS / 2N6565 EC103X	SxS3 EC103X3	
I _{GT}	V _D = 6V; R _L = 100 Ω		MAX.	12	50	200	500	μA
V _{GT}			MAX.	0.8				V
V _{GRM}	IRG=10uA		MIN.	5				
dv/dt	V _D = V _{DRM} ; R _{GK} = 1kΩ	400V	MIN.	20	25	30	40	V/μs
		600V		10	10	15	20	
V _{GD}	V _D = V _{DRM} ; R _L = 3.3 kΩ; T _J = 110°C		MIN.	0.2	0.25			V
I _H	I _T = 20mA (initial), R _{GK} = 1kΩ		MAX.	5			8	mA
t _q	(1)		MAX.	60		50	45	μs
t _{gt}	I _G = 2 × I _{GT} ; PW = 15μs; I _T = 1.6A		TYP.	2	5	20	30	μs

(1) I_T=1A; t_p=50μs; dv/dt=5V/μs; di/dt=-5A/μs

Static Characteristics

Symbol	Test Conditions			Value	Unit	
V _{TM}	I _T = 1.2A; t _p = 380 μs			MAX.	1.7	V
I _{DRM} / I _{RRM}	V _{DRM} = V _{RRM} R _{GK} = 1kΩ	T _J = 25°C	MAX.		1	μA
		T _J = 100°C			50	
		T _J = 110°C			100	

Thermal Resistances

Symbol	Parameter		Value	Unit	
R _{θ(J-C)}	Junction to case (AC)	EC103xy/2N6565	75	°C/W	
		SxSy	60*		
R _{θ(J-A)}	Junction to ambient		EC103xy/2N6565	160	°C/W

Notes: x = voltage, y = sensitivity

* = Mounted on 1 cm² copper (two-ounce) foil surface

Figure 1: Normalized DC Gate Trigger Current vs. Junction Temperature

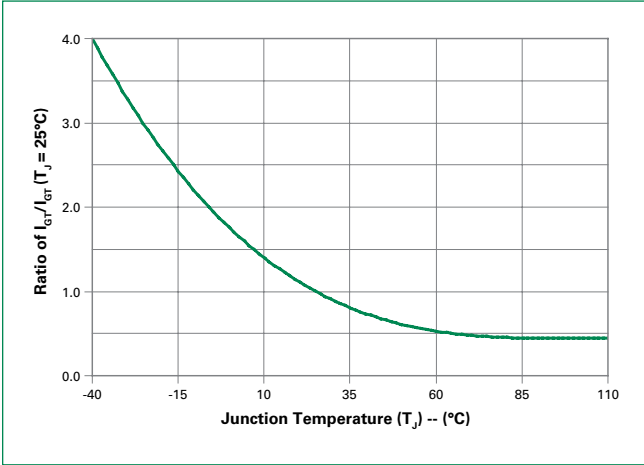

Figure 2: Normalized DC Gate Trigger Voltage vs. Junction Temperature

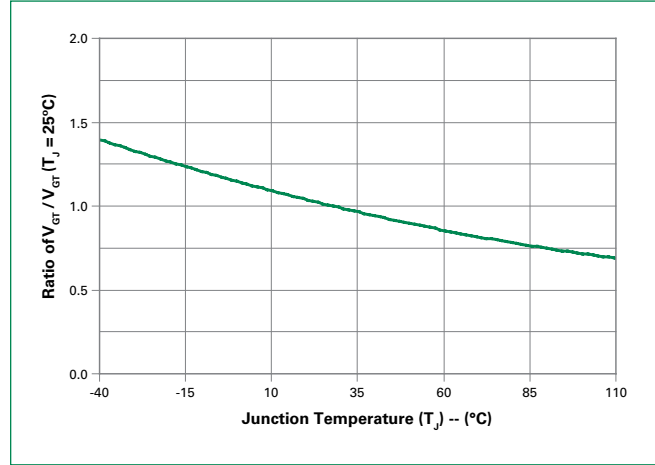

Figure 3: Normalized DC Holding Current vs. Junction Temperature



Figure 4: On-State Current vs. On-State Voltage (Typical)



Figure 5: Power Dissipation (Typical) vs. RMS On-State Current

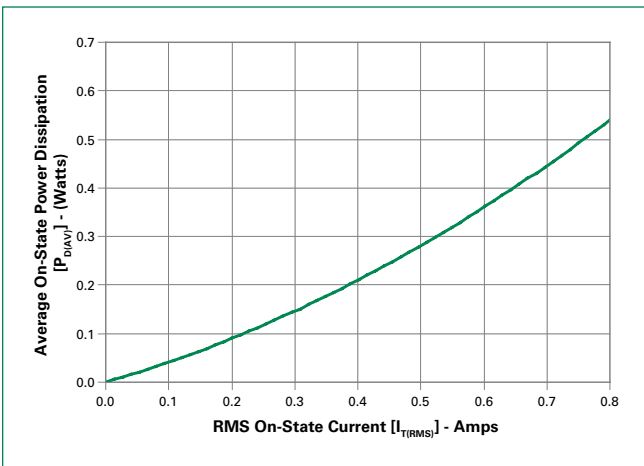

Figure 6: Maximum Allowable Case Temperature vs. RMS On-State Current



Figure 7: Maximum Allowable Case Temperature vs. Average On-State Current

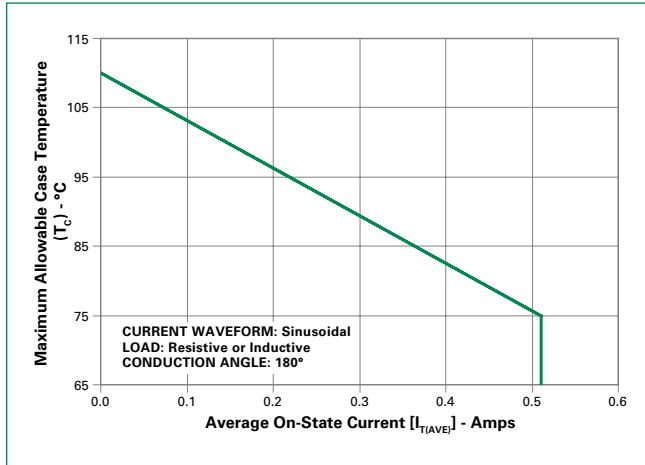

Figure 8: Maximum Allowable Ambient Temperature vs. RMS On-State Current

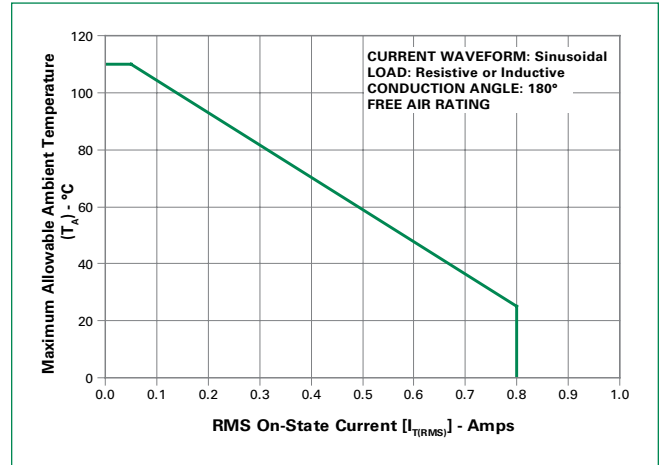

Figure 9: Maximum Allowable Ambient Temperature vs. Average On-State Current

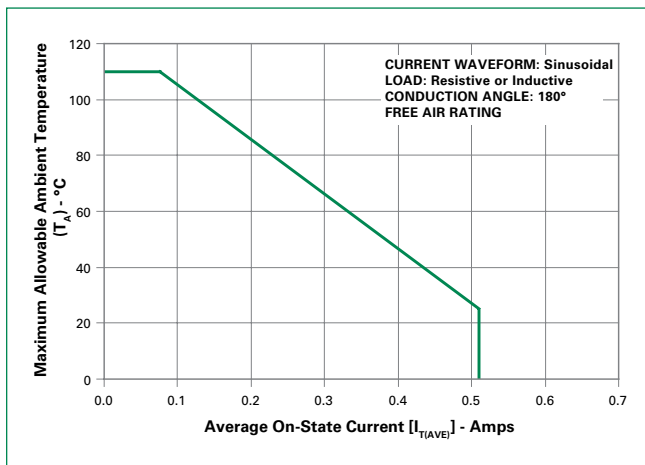

Figure 10: Peak Capacitor Discharge Current

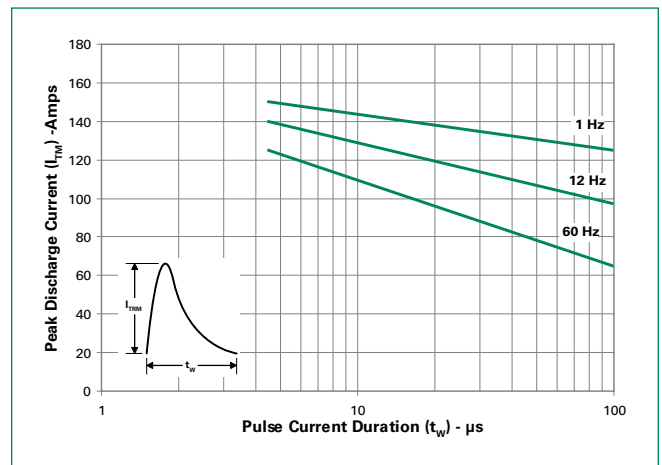

Figure 11: Peak Repetitive Sinusoidal Pulse Current

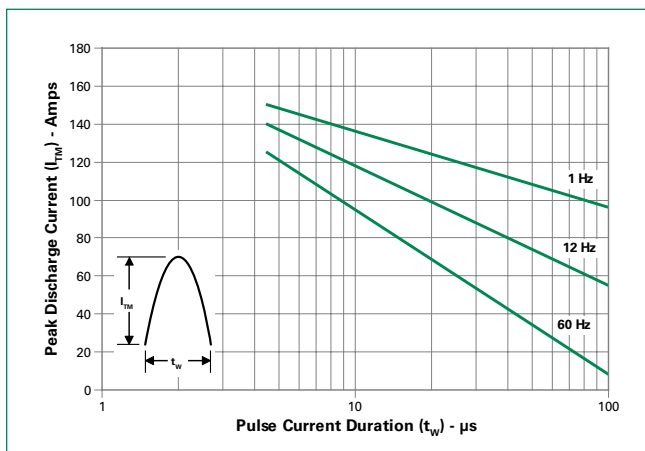

Figure 12: Surge Peak On-State Current vs. Number of Cycles

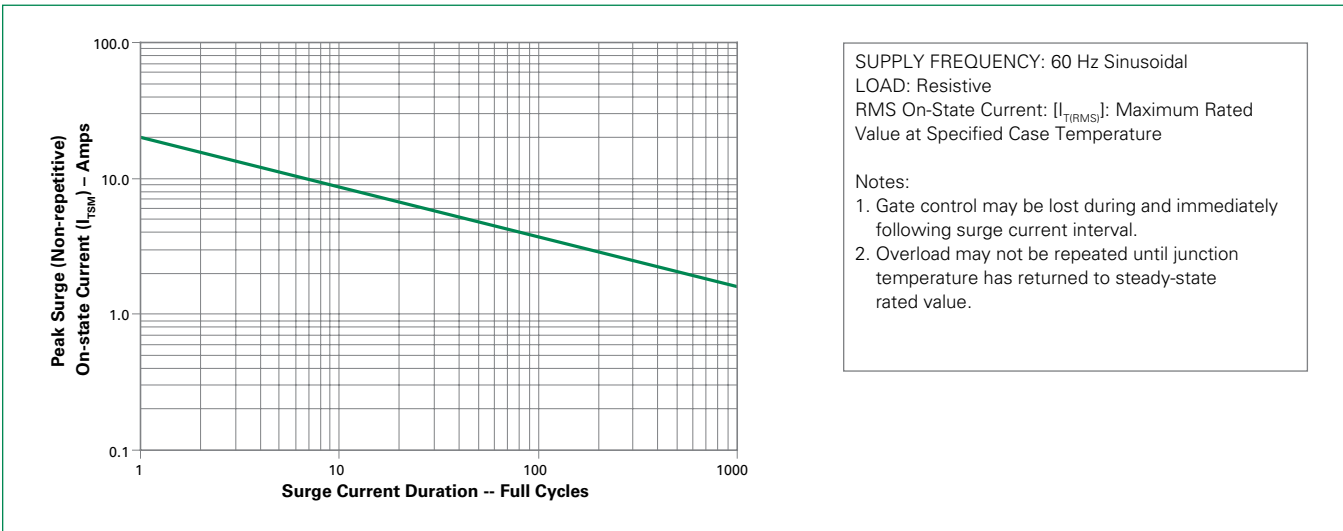

Figure 13: Simple Test Circuit for Gate Trigger Voltage and Current



Note: V1 — 0 V to 10 V dc meter
V_{GT} — 0 V to 1 V dc meter
I_G — 0 mA to 1 mA dc milliammeter
R1 — 1 k potentiometer

To measure gate trigger voltage and current, raise gate voltage (V_{GT}) until meter reading V1 drops from 6 V to 1 V. Gate trigger voltage is the reading on V_{GT} just prior to V1 dropping. Gate trigger current I_{GT} can be computed from the relationship

$$I_{GT} = I_G \cdot \frac{V_{GT}}{1000} \text{ Amps}$$

where I_G is reading (in amperes) on meter just prior to V1 dropping

Note: I_{GT} may turn out to be a negative quantity (trigger current flows out from gate lead). If negative current occurs, I_{GT} value is not a valid reading. Remove 1 k resistor and use I_G as the more correct I_{GT} value. This will occur on 12 μA gate products.

Soldering Parameters

Reflow Condition		Pb – Free assembly
Pre Heat	- Temperature Min ($T_{s(min)}$)	150°C
	- Temperature Max ($T_{s(max)}$)	200°C
	- Time (min to max) (t_s)	60 – 180 secs
Average ramp up rate (Liquidus Temp) (T_L) to peak		5°C/second max
$T_{s(max)}$ to T_L - Ramp-up Rate		5°C/second max
Reflow	- Temperature (T_L) (Liquidus)	217°C
	- Temperature (t_l)	60 – 150 seconds
Peak Temperature (T_p)		260 ^{+0/-5} °C
Time within 5°C of actual peak Temperature (t_p)		20 – 40 seconds
Ramp-down Rate		5°C/second max
Time 25°C to peak Temperature (T_p)		8 minutes Max.
Do not exceed		280°C



Physical Specifications

Terminal Finish	100% Matte Tin-plated/Pb-free Solder Dipped
Body Material	UL recognized epoxy meeting flammability classification 94V-0
Lead Material	Copper Alloy

Design Considerations

Careful selection of the correct device for the application's operating parameters and environment will go a long way toward extending the operating life of the Thyristor. Good design practice should limit the maximum continuous current through the main terminals to 75% of the device rating. Other ways to ensure long life for a power discrete semiconductor are proper heat sinking and selection of voltage ratings for worst case conditions. Overheating, overvoltage (including dv/dt), and surge currents are the main killers of semiconductors. Correct mounting, soldering, and forming of the leads also help protect against component damage.

Environmental Specifications

Test	Specifications and Conditions
AC Blocking	MIL-STD-750, M-1040, Cond A Applied Peak AC voltage @ 110°C for 1008 hours
Temperature Cycling	MIL-STD-750, M-1051, 100 cycles; -40°C to +150°C; 15-min dwell-time
Temperature/Humidity	EIA / JEDEC, JESD22-A101 1008 hours; 320V - DC: 85°C; 85% rel humidity
High Temp Storage	MIL-STD-750, M-1031, 1008 hours; 150°C
Low-Temp Storage	1008 hours; -40°C
Resistance to Solder Heat	MIL-STD-750 Method 2031
Solderability	ANSI/J-STD-002, category 3, Test A
Lead Bend	MIL-STD-750, M-2036 Cond E

Dimensions – TO-92 (E Package)



Dimension	Inches		Millimeters	
	Min	Max	Min	Max
A	0.176	0.196	4.47	4.98
B	0.500	-	12.70	-
D	0.095	0.105	2.41	2.67
E	0.150	-	3.81	-
F	0.046	0.054	1.16	1.37
G	0.135	0.145	3.43	3.68
H	0.088	0.096	2.23	2.44
J	0.176	0.186	4.47	4.73
K	0.088	0.096	2.23	2.44
L	0.013	0.019	0.33	0.48
M	0.013	0.017	0.33	0.43

All leads insulated from case. Case is electrically nonconductive.

Dimensions – Compak (C Package)

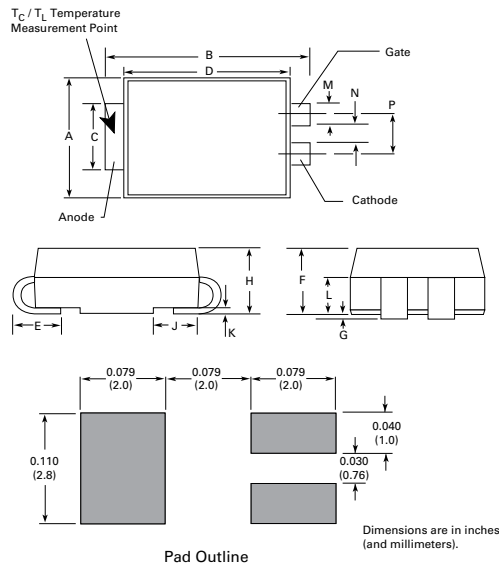

Dimension	Inches		Millimeters	
	Min	Max	Min	Max
A	0.130	0.156	3.30	3.95
B	0.201	0.220	5.10	5.60
C	0.077	0.087	1.95	2.20
D	0.159	0.181	4.05	4.60
E	0.030	0.063	0.75	1.60
F	0.075	0.096	1.90	2.45
G	0.002	0.008	0.05	0.20
H	0.077	0.104	1.95	2.65
J	0.043	0.053	1.09	1.35
K	0.006	0.016	0.15	0.41
L	0.030	0.055	0.76	1.40
M	0.022	0.028	0.56	0.71
N	0.027	0.033	0.69	0.84
P	0.052	0.058	1.32	1.47

Product Selector

Part Number	Voltage				Gate Sensitivity	Type	Package
	400V	600V	800V	1000V			
EC103 x 1	X	X			12μA	Sensitive SCR	TO-92
EC103 x 2	X	X			50μA	Sensitive SCR	TO-92
EC103 x	X / 2N6565	X			200μA	Sensitive SCR	TO-92
EC103 x 3	X	X			500μA	Sensitive SCR	TO-92
S x S1	X	X			12μA	Sensitive SCR	Compak
S x S2	X	X			50μA	Sensitive SCR	Compak
S x S	X	X			200μA	Sensitive SCR	Compak
S x S3	X	X			500μA	Sensitive SCR	Compak

Note: x = Voltage

Packing Options

Part Number	Marking	Weight	Packing Mode	Base Quantity
EC103xy / 2N6565	EC103xy / 2N6565	0.19 g	Bulk	2000
EC103xyRP	EC103xy	0.19 g	Reel Pack	2000
EC103xyAP	EC103xy	0.19 g	Ammo Pack	2000
SxSyRP	SxSy	0.08 g	Embossed Carrier	2500

Note: x = Voltage, y = sensitivity

TO-92 (3-lead) Reel Pack (RP) Radial Leaded Specifications

Meets all EIA-468-C Standards



TO-92 (3-lead) Ammo Pack (AP) Radial Leaded Specifications

Meets all EIA-468-C Standards



Compak Embossed Carrier Reel Pack (RP) Specifications

Meets all EIA-481-1 Standards



Part Numbering System (TO-92)

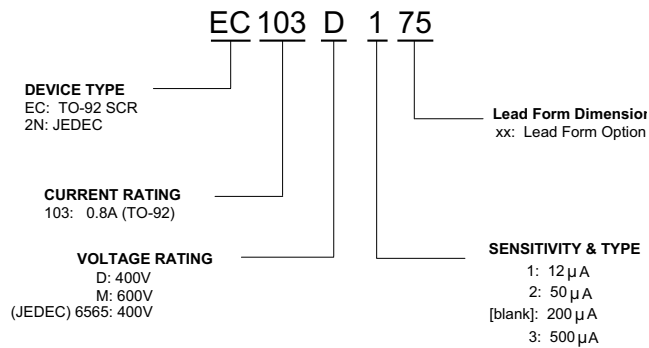

Part Marking System

TO-92 (E Package)



Date Code Marking
Y: Year Code
M: Month Code
L: Location Code
XX: Lot Serial Code

Part Numbering System (Compak)

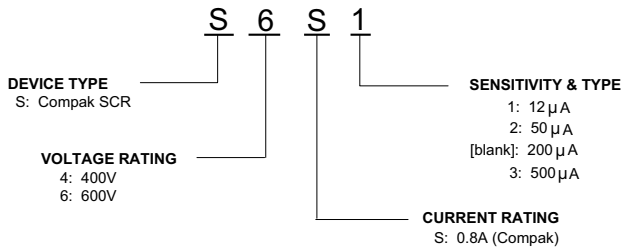

Part Marking System (Compak)

Compak (C Package)

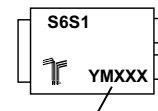

Date Code Marking
Y: Year Code
M: Month Code
XXX: Lot Trace Code