

enerSol



EnerSol 135

+ 0/+5 WP POSITIVE TOLERANCE

🏠 ROOFTOP AND OFF-GRID DESIGN

✓ HIGH QUALITY

25 year linear performance warranty
10 year product warranty



enerSol

High quality solar panels designed
for rooftop and off-grid applications



EnerSol 135

General characteristics

Cell	polycrystalline solar cell 156 x 156 mm
No. of Cells (Connections)	36 (4x9)
Panel Dimensions	1480 x 670 x 35 mm
Weight	11.6 kg
Connectors and Cables	Connectors and 1m cables

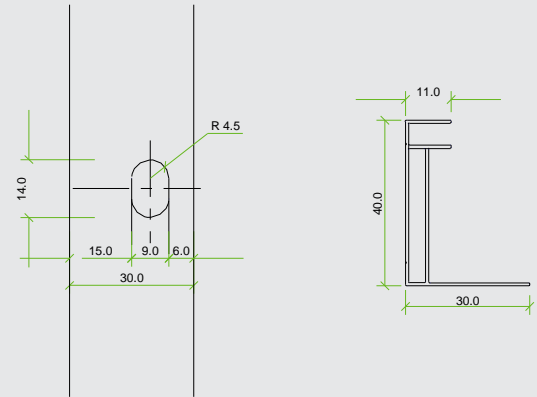
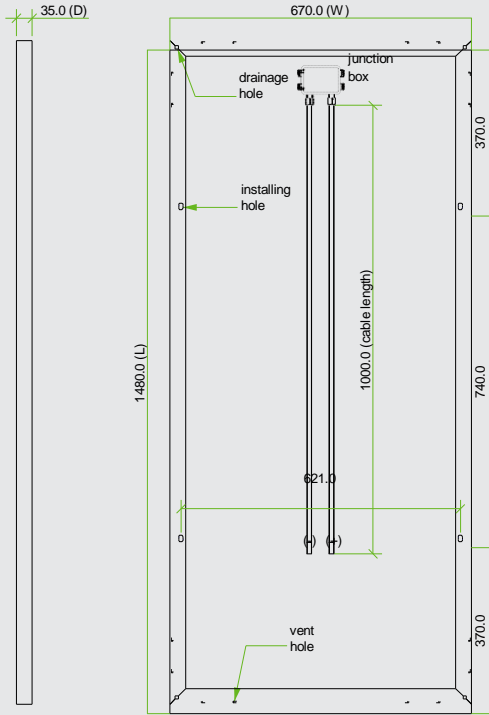

Thermal conditions

Normal Operating Cell Temperature 800W/m ² Irradiance, 20°C, AM = 1.5	48°C ± 2°C
Power Temperature Coefficient	- 0.5%/K
Current Temperature Coefficient	0.035%/K
Voltage Temperature Coefficient	- 0.37 MV/K

Limits

Operating Temperature	- 40°C to 85°C
Maximum System Voltage	1000V DC

Electric performance at STC *

Maximum Power	135 Wp
Power Tolerance	0/+5 Wp
Maximum Power Voltage	18 V
Maximum Power Current	7.50 A
Open Circuit Voltage	22.2 V
Short Circuit Current	8.43 A

*Standard Test Conditions : 1000W/m² irradiance, 25°C and AM = 1.5

High performance

25 25 Years
linear performance

10 10 Years
product warranty

