





規格
SPECIFICATIONS

額定

1. Rating: 16A/20A 250VAC
絕緣電阻
2. Insulation Resistance: DC 500V 100M Min.
耐電壓
3. Dielectric Strength: AC 2000V 1Minute
材料規格
4. Housing Material: Nylon#66 94V-2 or 94V-0
認可安規
5. Safety approval:   

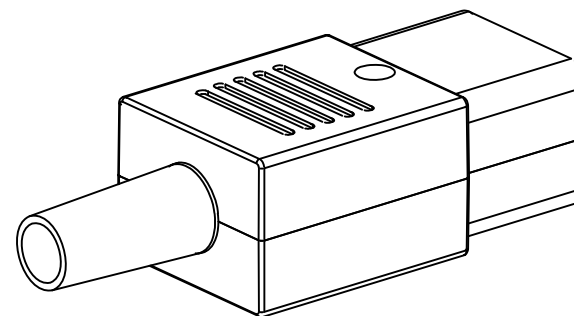

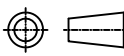
富灣股份有限公司
RICH BAY COMPANY LTD.
台北縣樹林市東興街57號
NO. 57, Tung Hsing St., Shu-Lin Town,
Taipei Hsien, Taiwan, R. O. C.
TEL: 886-2-86867781~4 FAX: 886-2-86867780
http://www.richbay.com.tw

 DRAWN BY	UNIT	UNIT QTY	SCALE	TOLERANCE		PRODUCT NO.	JA-2261	REV
	mm	1	1:1					
 RD 107.01.04 林文啟	APPROVED BY		 RD 107.01.04 張育誠	ID NO	180104A01	INTERIM NO.		C
				DESCRIPTION				