

## Solid State Relay

### KSI380 Series Single Phase AC Output



- Zero switching or random-on
- Ratings from 10A to 100A @ 48-440VAC
- Triac or SCR output for heavy industrial loads
- AC or DC input
- Superior thermal performance
- Dielectric strength 4000VACrms
- LED indication
- Internal RC/MOV and TVS protection circuit as option

#### Product Description

KSI380 series industrial single phase relay with triac or SCR output is the most widely used in industry application. The relay can be used for resistive, inductive and capacitive loads. The control input voltage is 4-32VDC or 85-280VAC, output current rate 10A, 25A, 40A, 60A, 80A, 100A @ 48-440VAC.

#### Product Selection

<b>KSI</b>	<b>380</b>	<b>D/A</b>	<b>25</b>	<b>R</b>	<b>-L</b>	<b>M</b>
KSI Series	Load Voltage 380:380VAC	Control Voltage D:DC Control A:AC Control	Load Current 10:10Amp 25:25Amp 40:40Amp 60:60Amp 80:80Amp 100:100Amp	Switching Mode None:Zero Crossing R:Random-on	L:LED	M:MOV T:TVS (Option)

Description	10A	25A	40A	60A	80A	100A
D:4-32VDC	KSI380D10	KSI380D25	KSI380D40	KSI380D60	KSI380D80	KSI380D100
	KSI380D10R	KSI380D25R	KSI380D40R	KSI380D60R	KSI380D80R	KSI380D100R
AC:85-280VAC	KSI380A10	KSI380A25	KSI380A40	KSI380A60	KSI380A80	KSI380A100

#### Technical Specification

##### Input Circuit

Control Voltage Range	DC Input	4-32VDC
	AC Input	85-280VAC
Minimum Turn-On Voltage	DC Input	4VDC
	AC Input	85VAC
Minimum Turn-Off Voltage	DC Input	1VDC
	AC Input	10VAC
Maximum Input Current	DC Input	25mA
	AC Input	10mA

##### Output Circuit

Load Voltage Range	48-440VAC	
Maximum Turn-On Time	Random-On	1ms
	Zero Crossing	1/2AC Cycle + 1ms

	AC Input	20ms
Maximum Turn-Off Time	DC Input	1/2AC Cycle + 1ms
	AC Input	40ms
Maximum Surge Current [@10ms]	10A	150A
	25A	400A
	40A	440A
	60A	860A
	80A	1280A
	100A	1550A
Maximum I <sup>2</sup> t For Fusing [@10ms]	10A	350A <sup>2</sup> S
	25A	900A <sup>2</sup> S
	40A	970A <sup>2</sup> S
	60A	3698A <sup>2</sup> S
	80A	8192A <sup>2</sup> S
	100A	12012A <sup>2</sup> S
Transient Overvoltage		800Vpk
Maximum Off-State Leakage Current [@ Rated Voltage]		5mA
Maximum On-State Voltage Drop [@ Rated Current]		1.6Vrms
Minimum Off-State dv/dt [@ Maximum Rated Voltage]		500 V/μs

### General Information

Dielectric Strength,  
Input/Output/Base [50/60Hz]  $\geq 4000\text{Vrms} / 2500\text{Vrms}$

Ambient Operating  
Temperature Range  $-30^{\circ}\text{C} \sim +80^{\circ}\text{C}$

Ambient Storage  
Temperature Range  $-30^{\circ}\text{C} \sim +100^{\circ}\text{C}$

Weight [typical] 85g

### Application

High-low Temperature Chamber, Plastics Machinery, Incubation Machine, Oiling Machine, HVAC, Elevator, Lighting, Fountain Controller.

### Installation

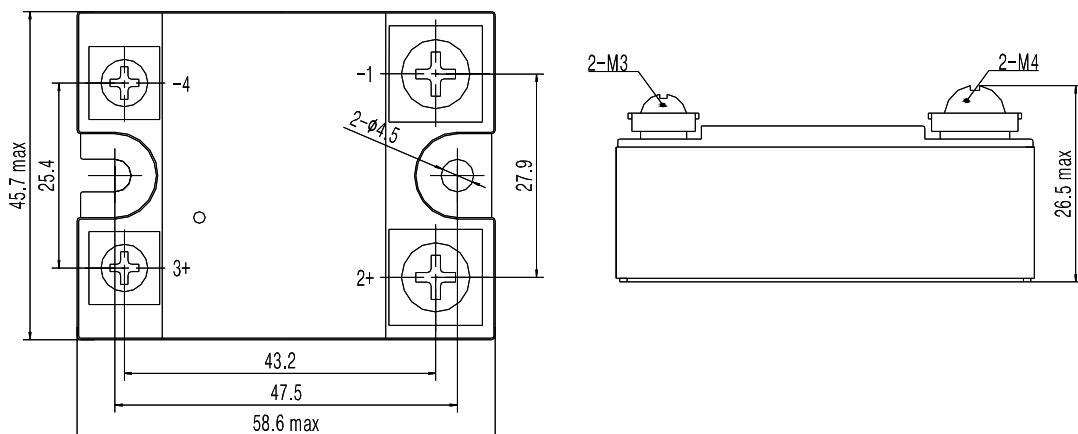

## Thermal Curve

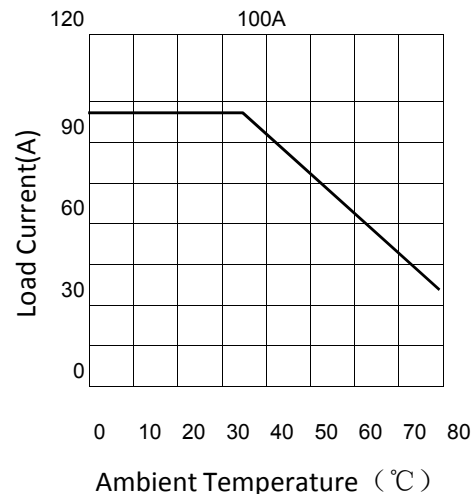
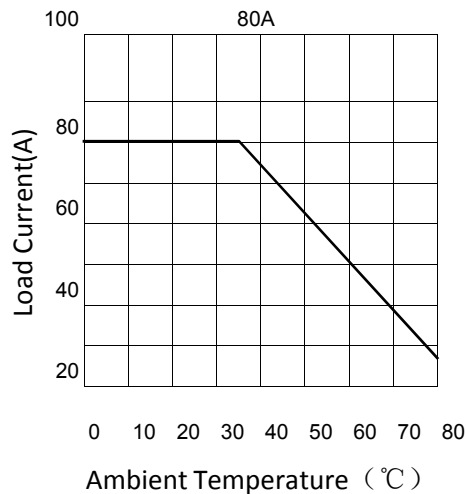
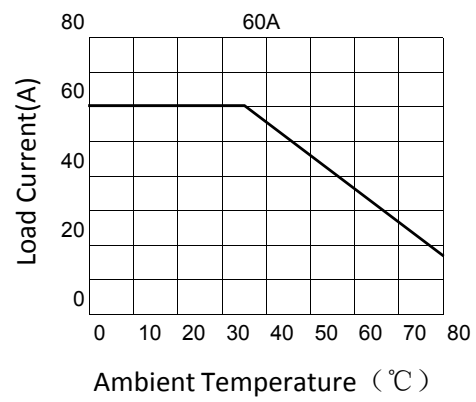
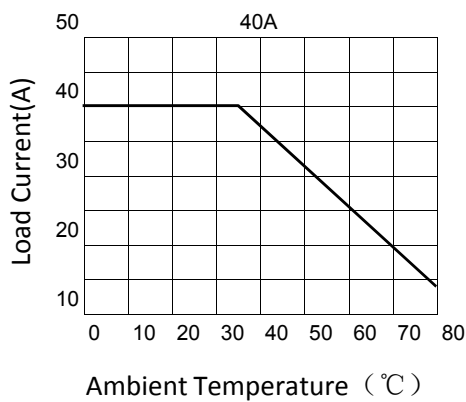
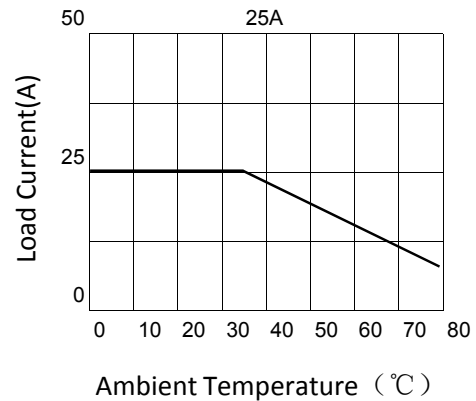
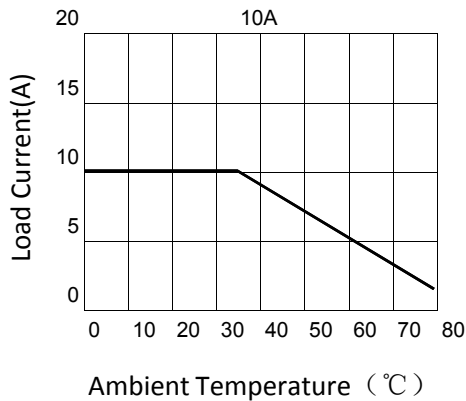

## Important Notice

1. When the ambient temperature is over 40°C or many KSI series are installed closely together, the user should take load discount into account according to the thermal curve.
2. If the load current is over 10A, suitable heatsink should be added to the SSR.

## Product Certification



@Kudom Electronics Technology, All Right Reserved

Kudom Electronics Technology  
www.kudom-elec.com