

*Your excellent helper in
measuring instruments.*

NF-826

UNDERGROUND WIRE LOCATOR USER MANUAL



Your excellent helper in measuring instruments.

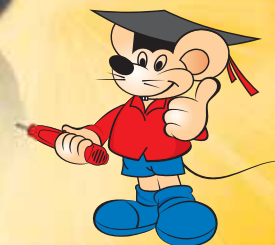

VER: V2



Please read and understand the safety precautions before using or servicing this equipment.

Precautions

1. The working temperature of this tester is 0-40°C (32-104°F)
2. In order to avoid damage to the detector, severe mechanical vibration should be avoided during handling and use, especially to avoid falling accidents, and avoid long-term direct sunlight and strong electromagnetic areas.
3. Only professionals can calibrate and repair the detector.
4. Before each use, check whether the detector and the measuring line are damaged. Please make sure that the detector and the measuring line used are in good condition.
5. When using the detector, the rated voltage of the tested circuit cannot be greater than the rated voltage of 400V.
6. When the transmitter is connected to a live power grid, if the "ground" jack of the transmitter is connected to the protective ground, when there is leakage current in the power supply line, this leakage current and the loop current of the transmitter may combine, which may cause leakage. The protection switch trips, which triggers the FI/RCD disconnection.

CONTENTS

1. Overview	01
1.1 Product Introduction	01
1.2 Parts and Functions	01
1.2.1 Components and Functions Description.....	01
1.2.2 Display interface Description	02
1.3 Accessories Description.....	03
NF-826 Underground & In-Wall Cable Detector Features	04
Three common methods of use	04
2. Function and Usage	05
2.1 Switch Machine	05
2.2 Set Transmission Signal Level (Transmitter).....	05
2.3 Set Transmitter Code (Transmitter).....	05
2.4 Start/pause Transmitting Signal (Transmitter)	05
2.5 Sensitivity Mode Setting (Receiver)	05
2.6 Lighting Function	05
2.7 Backlight Function	06
2.8 Transmitter Voltage Test Function.....	06
2.9 Mute Function	07
2.10 Automatic Shutdown Function.....	07
2.11 NCV Tester Function (Receiver).....	07
3. Wiring Specifications and Methods	08
3.1 Unipolar Application	08
3.2 Bipolar Application-Connection to Live Grid.....	09
3.3 Bipolar Application-Connection to Unpowered Grid.....	10
3.4 Find the Cable Layout Direction (Uncharged line)	12
3.5 Find the Cable Break-Point (Uncharged line)	13
3.6 Find the Short-Circuit Point of the Cable (Uncharged line)	14

4. Description of Practical Examples	15
4.1 Example of Cable Routing	15
4.1.1 Tracking Underground Lines	15
4.1.2 Detection of Buried Metal Water Pipes and Metal Heating Pipes	16
4.1.3 Detect User Allocation of Three-phase Power Supply Lines on the Same Floor ...	17
4.1.4 Find the Fuse Corresponding to the Line	18
4.2 Example of Cable Break-point	19
4.2.1 Use Two Transmitters to Find Cable Break-point Fault	19
4.2.2 Find the Open Circuit Fault in Electrical Floor Heating	20
4.3 Find Blockage Points in Buried Non-metallic Pipes	21
4.4 Classification or Determination of laid lines	22
5. Depth of Detection Improve Methods	23
5.1 Detect lines with larger buried depths	23
5.2 Effective Radius of live line search improve Methods	24
6. Technical Parameters	25
7. Maintenance	26
7.1 Checklist for common faults	27
7.2 Cleaning	27
8. Parts list	27

Product description

NF-826 Underground & In-Wall Cable Detector is a portable instrument, which consists of transmitter, receiver and accessories.

Selecting new integrated devices and digital circuit technology, the electrical performance is stable and reliable. According to the change of the signal, the specific location and fault of the buried cable or pipeline can be detected. It is suitable for the maintenance of communication cable construction, power cable construction, building pipeline construction, communication cable and power supply line and electric heating line.

1.2.1 Description of components and functions



1.2.2 Display interface description

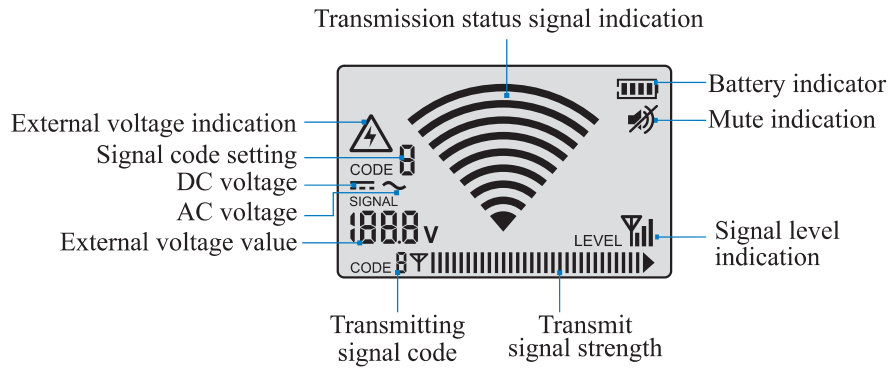

Launcher interface

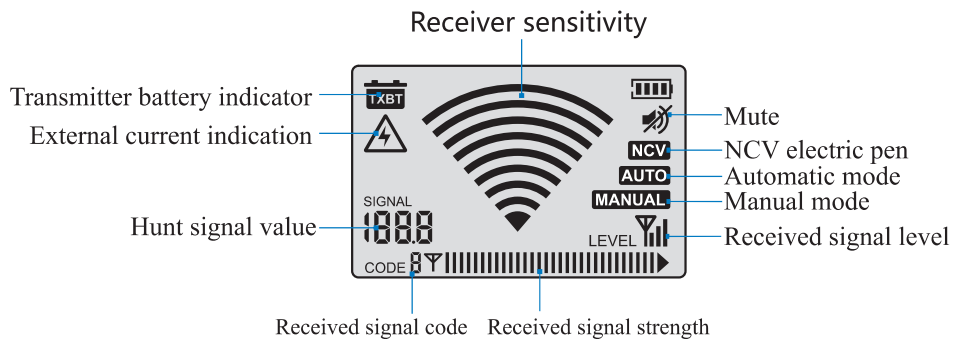

Receiver interface

There are 6 kinds of codes, namely A/C/E/F/H/L, which can be switched in cycles when setting

1.3 Accessories description



1. The connecting wire is used to connect the transmitter to the alligator clip or test pen



2. Alligator clip is used to clamp the target line



3. The test pen is used to touch the target line



4. The ground rod is used to connect to the underground in an environment where there is no ground wire, thereby increasing the test signal

Notice:

1. The red connecting wire-end is connected to the red alligator clip or red test pen, and the other-end is connected to the positive port of the transmitter.
2. The black connecting wire-one end is connected to a black alligator clip or a black test pen, the other-end is connected to the ground wire or the ground rod is connected to the ground.
3. The alligator clip has the same function as the test pen, and you can choose easy-to-operate accessories under different construction environments

Characteristics of Cable Locator NF-826

- ◆ Detecting cables, electrical lines, water/gas supply pipelines buried in wall or earth;
- ◆ Detecting interruptions and short circuit in cables and electrical lines buried in wall or earth;
- ◆ Detecting fuses and assigning current circuits;
- ◆ Tracing sockets and distribution sockets having accidentally been covered by plastering;
- ◆ Detecting interruptions and short-circuits in floor heating;
- ◆ The transmitter is integrated with the function of AC/DC voltmeter, which can measure 12 to 400V AC/DC voltage on a linear basis:
AC: 12 ~ 400V (50 to 60 Hz) ± 2.5%
DC: 12 ~ 400V ± 2.5%
- ◆ The screen of the transmitter can display preset transmitting power, transmitted codes, its own battery energy, mains voltage detected, AC/DC status of mains voltage detected, and warning symbol for mains voltage.
- ◆ The receiver can display the power level of the transmitter, the code of the transmitter, and the battery level of the transmitter and its own battery power status, detected AC voltage induction signal and lightning warning symbol
- ◆ Sensitivity adjustment function, mute function, automatic shutdown function, lighting function

Three common methods of use

1. Look for underground cables

Use the red clip (red needle) to clamp the cable that needs to be searched, and the black clip (black needle) to the ground wire, and the receiver traces the signal along the line to find the cable direction.

2. Look for short-circuit points of underground cables

Use the red clip/black clip to clamp the short-circuited wire separately, adjust the sensitivity to an appropriate level, the receiver will sound before the short-circuit point, and the receiver will not sound after the short-circuit point.

3. Find underground cable breakpoints

The red clamp clamps the target line, the black clamp clamps all the remaining lines and then connects the ground rod to ground (good grounding is required), the receiver will sound before the break point, and the receiver will not sound after the break point.





2. Functions and instructions

2.1 Switch machine

Transmitter: Long press the launch switch key "  " to turn on, at this time the transmitter LCD screen displays the initial interface, and the buzzer beeps twice at the same time.



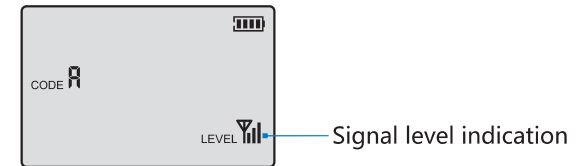

Receiver: Long press the transmitter switch key "  " to turn on, at this time the transmitter LCD screen displays the initial interface, and the buzzer sounds twice at the same time.

2.2 Set the transmission signal level (transmitter)

Short press the signal level setting key "  ", the signal level indicator flashes, short press the up and down keys "   " to select the signal level (there are three levels I II II), short press "  " to confirm and exit the signal level setting (transmit Signal level indication)



2.3 Set the transmit signal code (transmitter)

Short press the signal code setting key "  ", short press the up and down keys "   " to select the signal code, there are 6 types of signal codes, namely A/C/E/F/H/L, and then shortly press "  " after selection "Confirm and exit code setting. (Signal code setting)

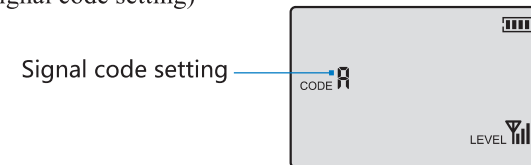

2.4 start/pause transmitting signal (transmitter)

Short press the start/pause button "  ", the transmitter starts to emit high-frequency signals, and the screen emission status indicator lights up one by one. (Emission code setting, emission status indication, emission signal level indication)

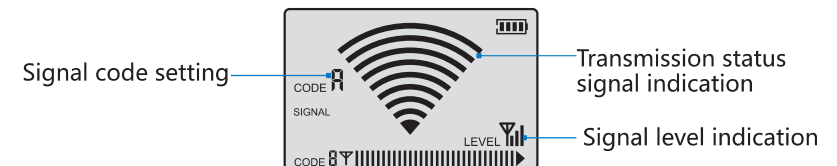

2.5 Sensitivity mode setting (receiver)

- * By default, it enters the automatic detection mode when it is turned on. Short press the mode switch key "MENU" to switch between automatic sensitivity mode and manual sensitivity mode cyclically
- * Automatic Sensitivity Mode: This mode adjusts the sensitivity to the maximum by default, which is suitable for quickly searching the approximate position of the target or using it in an environment with high depth.
- * Manual sensitivity mode: This mode needs to manually adjust the sensitivity, enter the manual sensitivity mode, short press the up and down keys "▲▼" to adjust the sensitivity to the appropriate level (the sensitivity is divided into 8 levels). This mode is suitable for precise positioning. First use high sensitivity to quickly locate the approximate position, and then lower the sensitivity to accurately locate the target position.

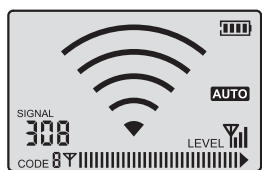

Automatic Sensitivity Mode

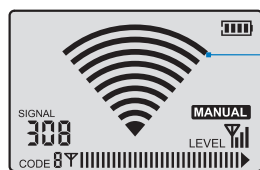

Manual sensitivity mode

Receiver sensitivity

2.6 Lighting function

Transmitter: Short press the transmitter lighting button "☰" to turn on the light, short press again to turn it off.

Receiver: Short press the receiver lighting button "☰" to turn on the light, short press again to turn off.

2.7 Backlight function

Transmitter: Long press the transmitter backlight key "☀" to turn on the backlight, and press the backlight key again to turn off the backlight.

Receiver: Short press the receiver backlight key "☀" to turn on the backlight, and press the backlight key again to turn off the backlight.

2.8 Transmitter voltage test function

If the transmitter is connected to a live line and the voltage is greater than 12V, the lower left part of the transmitter display shows the value of the current voltage, and standard symbols are used to distinguish whether it is AC or DC. At the same time, a lightning bolt with a triangular frame is displayed on the upper part of the display. Symbol recognition range is 12 ~ 400VDC/AC (AC: 50 ~ 60Hz)

2.9 Mute function

Transmitter: Short press the transmitter backlight/mute button "☰" to turn off the sound, and press the backlight/mute button again "☰" to turn on the sound.

Receiver: Short press the receiver mute button "☰" to turn off the sound, and press the receiver mute button "☰" again to turn on the sound.

2.10 Automatic shutdown function

Transmitter: In the state of not transmitting a signal, no button is pressed within 15 minutes, the transmitter automatic shut-down.

Receiver: If there is no button operation within 15 minutes, the receiver will automatically shut down.

2.11 NCV tester function (receiver)

Short press the receiver's NCV button "NCV" to enter the electric tester function, the UAC indicator will light up on the screen; use the receiver probe to get close to the live cable, the receiver receives the signal, and emits a "di di" sound prompt, the closer you receive it The stronger the signal, the louder the sound.

3. Wiring specifications and methods

NF-826 Underground & In-Wall Cable Detector has the following wiring methods: unipolar application, bipolar application-connected to a live power grid, and bipolar application-connected to a non-live power grid.

3.1 Unipolar application

Unipolar application principle: The target wire is connected to the positive pole of the transmitter, and the negative pole of the transmitter is connected to the ground. At this time, the transmitter transmits a high-frequency signal to the target wire. After the signal passes through the conductor, it enters the air and returns to the ground, forming a closed loop, just like a radio transmitter. In the case of radio receivers, the specific wiring method is as follows.

1. Connect one end of the red cable to the positive port of the transmitter and the other end to the red alligator clip, and use the alligator clip to clamp the target line to be tested.
2. Connect one end of the black cable to the negative terminal of the transmitter, and the other end to the black alligator clip, and clamp the grounding rod with the alligator clip, and nail the grounding rod into the outdoor ground.

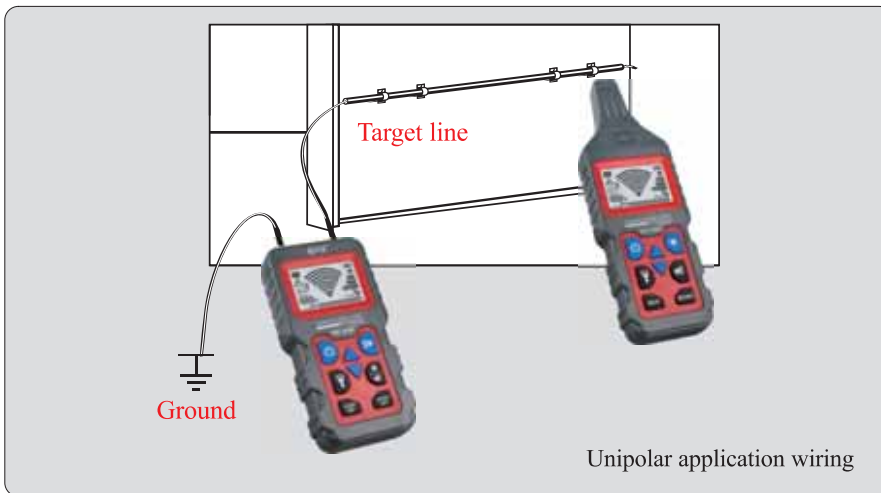

3.2 Bipolar application & live grid:

Connect the positive jack of the transmitter to the target wire, and the negative jack of the transmitter to the neutral wire of the line under test. In this case, if there is no load* in the line, the high-frequency signal is coupled from the transmitter to the neutral line and returns to the transmitter through the distributed capacitance between the lines.

No load: No electrical appliances are connected

1. Connect one end of the red cable to the positive port of the transmitter, and connect the other end to the red alligator clip, and use the alligator clip to clamp the live target wire to be tested.
2. Connect one end of the black cable to the negative terminal of the transmitter and the other end to the black alligator clip, and use the alligator clip to clamp the neutral wire in the cable.

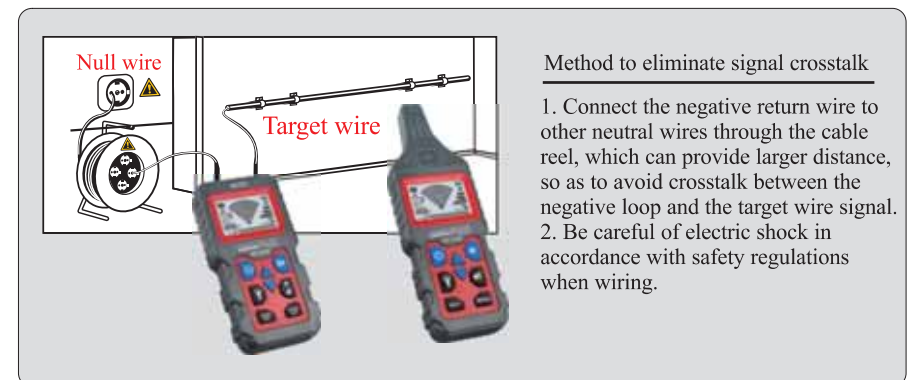
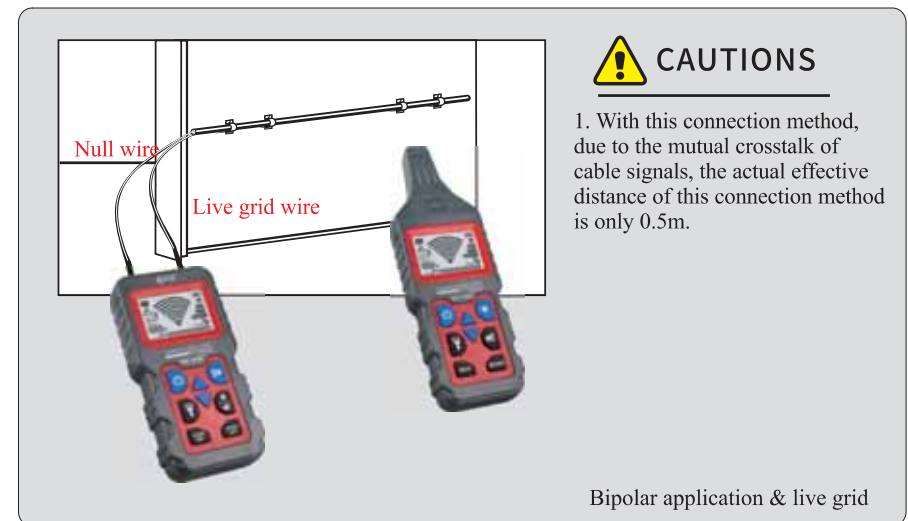

3.3 Bipolar application& unpowered grid:

Connect the positive jack of the transmitter to the target wire, and then connect the negative jack with another parallel wire of the circuit under test, and short the other two wires together. In this case, the high-frequency signal directly returns to the transmitter via the line. You can also connect the two connecting wires of the transmitter to the two ends of the target wire respectively. You can also connect the positive jack of the transmitter to a terminal of the tested circuit, and then connect the negative jack of the transmitter to the ground terminal of the target wire.

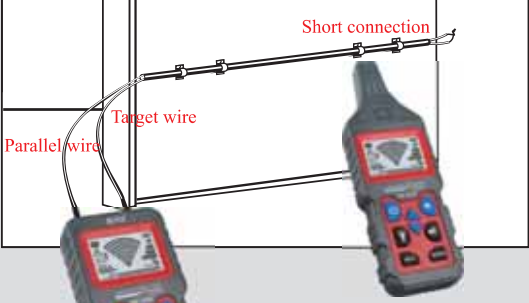

CAUTIONS

1. Due to signal crosstalk, the actual effective detection distance of this connection method is only 0.5m)

◆Bipolar application-unpowered wiring 1

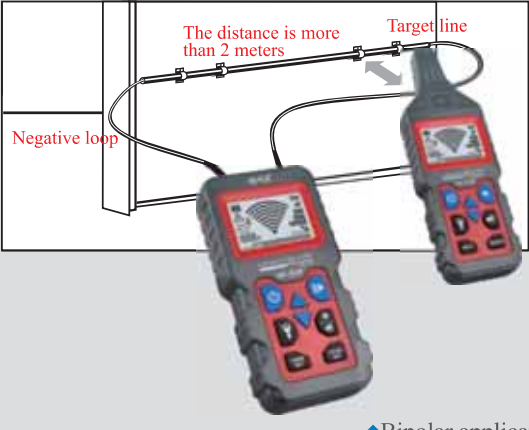

CAUTIONS

1. Due to signal crosstalk, the target wire of this connection must be at least 2m away from the negative loop, otherwise the detection distance will be very short.)

◆Bipolar application-unpowered wiring 2

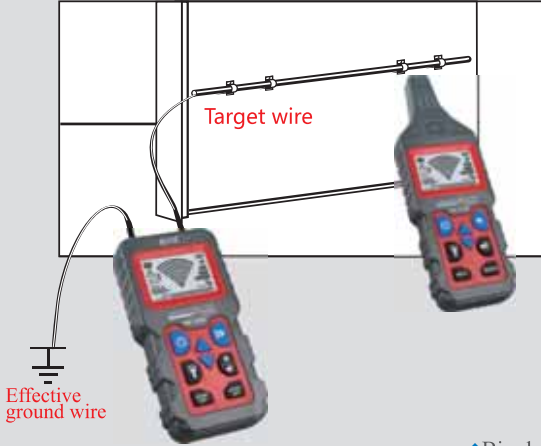

CAUTIONS

1. Use this connection method to ensure that the ground wire in the line must be an effective ground wire, otherwise the detection distance will be very short.
2. The effective ground wire must be more than 2m away from the target wire, otherwise it will Crosstalk between signals occurs and the detection distance is reduced.)

◆Bipolar application-unpowered wiring 3

The above 5 kinds of wiring methods are all the standard connection methods of the NF-826 underground & wall line finder. The line connection method is particularly important. All functional explanations are based on the standard connection method to achieve the expected effect. After understanding the line connection method After that, start to give instructions on its functions.

3.4 Find the cable layout direction (the line must be uncharged)

The wiring method can choose unipolar application, bipolar application-uncharged wiring 3, these two connection methods, if possible, it is recommended to prefer unipolar application. If the target wire has multiple parallel wires, the other non-target wires ①② also need to be grounded, as shown in the figure:

Note: The negative pole of the instrument must be connected to a valid ground wire or ground, otherwise the detection distance will become very short.

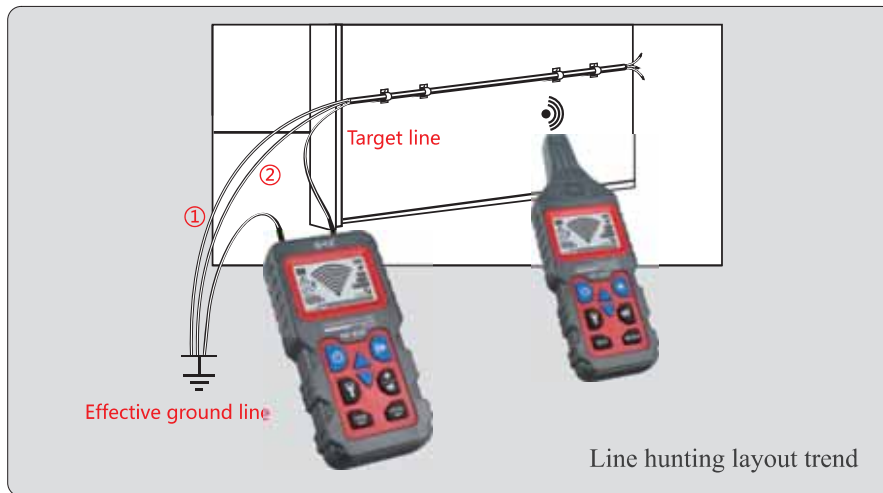

Instrument operation method

Step 1: Follow the instructions to connect the wires and turn on the transmitter and receiver.

Step 2: Set the signal level to be sent, and select the appropriate signal level according to the depth of the cable buried. After setting, start sending high frequency signal.

Step 3: Set the receiver sensitivity mode. After the mode is selected, use the receiver probe to approach the wall or the ground where the target wire is located and move it slowly.

When the receiver receives the signal, the receiving signal strength indicator on the screen lights up and sends out a "di di" Sound, the closer the receiver receives the stronger the signal, the louder the sound, and vice versa, the smaller.

Judgment method: by observing the signal received in the area detected by the receiver, the path with the strongest signal is the path laid by the target wire.

3.5 Find the cable break point (the line must be de-energized)

The wiring method can choose unipolar application, bipolar application-uncharged wiring 3, these two connection methods, it is recommended to prefer unipolar application if conditions permit. If the target wire has multiple parallel wires, the other non-target cables ①② also need to be grounded, as shown in the following figure:

Note: The negative pole of the instrument must be connected to a valid ground wire or earth, otherwise the detection distance will become very short.

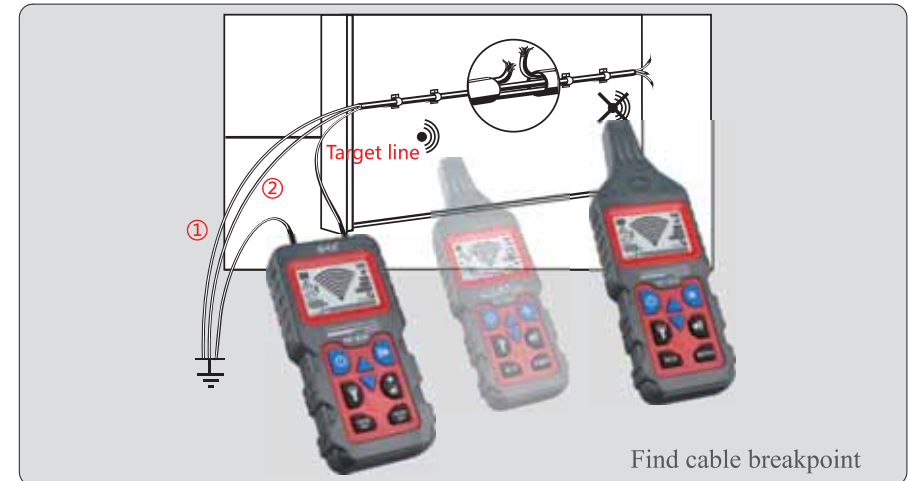

Instrument operation method

Step 1: Follow the instructions to connect the wires and turn on the transmitter and receiver.

Step 2: Set the signal level to be sent, and select the appropriate signal level according to the depth of the cable buried. After setting, start sending high frequency signal.

Step 3: Set the receiver sensitivity mode. After selecting the mode, use the receiver probe to approach the wall or ground where the target wire is located and move it slowly. When the receiver receives the signal, the receiving signal strength indicator on the screen lights up and sends out a "di di" Sound, the closer the distance, the stronger the signal received by the receiver, the louder the sound, and vice versa.

Operating skills: First adjust the receiver sensitivity mode to the automatic mode or manual mode high sensitivity gear, quickly determine the approximate location of the break-point, and then use the manual mode to lower the sensitivity gear to accurately locate the fault point.

Judgment method: When the receiver probe detects a certain point along the target wire path, the received signal suddenly attenuates, and the received signal disappears a little farther away, then this point is the disconnection point of the target wire.

3.6 Find the short-circuit point of the cable (the line must be uncharged)

Knowing that line ①② is short-circuited, the wiring method can be bipolar application-uncharged wiring 1. If the target wire has multiple parallel wires, the other non-target cables also need to be connected to the negative pole of the reflector, as shown in the figure.

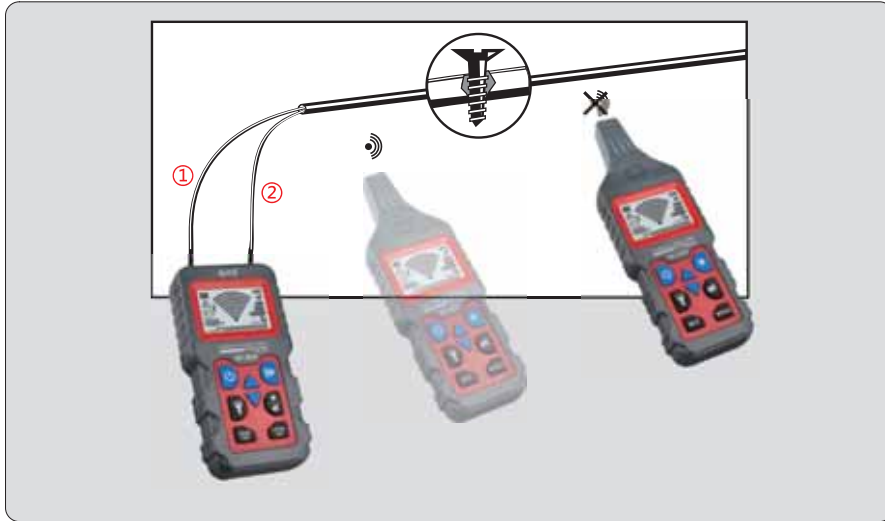

Step 1: Follow the instructions to connect the wires and turn on the transmitter and receiver.

Step 2: Set the signal level to be sent, and select the appropriate signal level according to the depth of the cable buried. After setting, start sending high frequency signal.

Step 3: Set the receiver sensitivity mode. After selecting the mode, use the receiver probe to approach the wall or ground where the target wire is located and move it slowly. When the receiver receives the signal, the receiving signal strength indicator on the screen lights up and sends out a "di di" Sound, the closer the distance, the stronger the signal received by the receiver, the louder the sound, and vice versa

Operating skills: first adjust the receiver sensitivity mode to the automatic mode or manual mode high sensitivity gear, quickly determine the approximate location of the break-point, and then use the manual mode to lower the sensitivity gear to accurately locate the fault point.

Judgment method: When the receiver probe detects a certain point along the wire path of ①②, the received signal suddenly attenuates, and the received signal disappears a little farther away, then this point is the short-circuit point of the wire ①②.

Notice:

1 The short-circuit point of the short-circuit line can only be found if its resistance is less than 200. The short-circuit resistance can be measured with a multi-meter.

2. The short-circuit test must be known-a short-circuit line and connect it to the positive terminal of the transmitter, otherwise it cannot be tested.

4. Description of practical examples

4.1 Example of cable routing

4.1.1 Tracking underground lines

Prerequisites:

- The line to be tested must be uncharged;
- Connect the transmitter according to the single-pole application wiring method;
- Operate the instrument in accordance with the cable routing method;
- Find or track the line by observing the strength of the received signal of the receiver. The stronger the signal, the closer to the receiver.

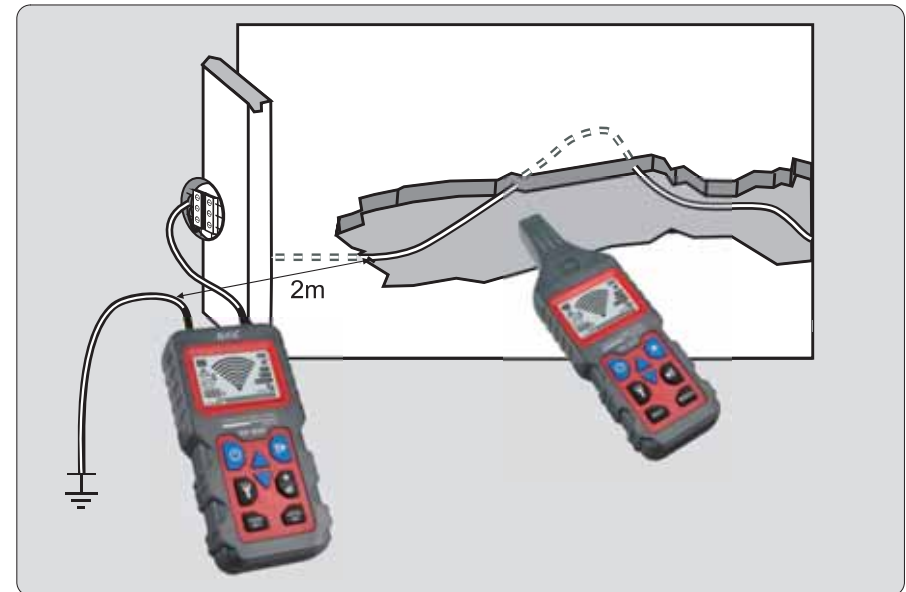

CAUTIONS

1. The distance between the ground wire and the detection circuit should be as large as possible. If the distance is too small, the signal and line cannot be accurately located.
2. The detection depth is largely affected by the ground conditions. Choosing an appropriate receiving sensitivity can accurately locate the detection line.
3. The farther away from the transmitter, the weaker the signal strength and the lower the detection depth

4.1.2 Detect buried metal water pipes and metal heating pipes

Prerequisites:

- The pipeline must be made of metal materials (such as galvanized steel pipe);
- The pipeline to be detected cannot be the ground line, and there should be a large resistance between it and the soil (if the resistance is too small, the detection distance will be small);
- Connect the positive jack of the transmitter with the pipeline under test with a connecting wire, and connect the negative pole to the ground;
- Operate the instrument in accordance with the cable routing method;
- Find or track the line by observing the received signal strength of the receiver, the stronger the signal, the closer to the receiver;
- The metal water pipe laid by tracking is shown in Figure 4.1.2-1 and the heating pipeline is shown in Figure 4.1.2-2:

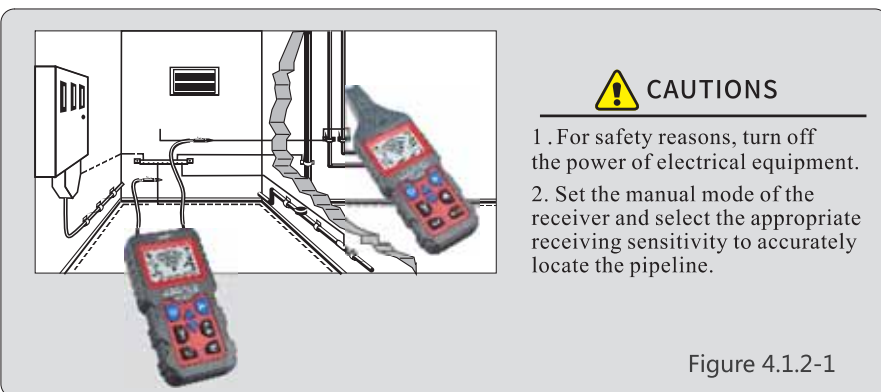

Figure 4.1.2-1

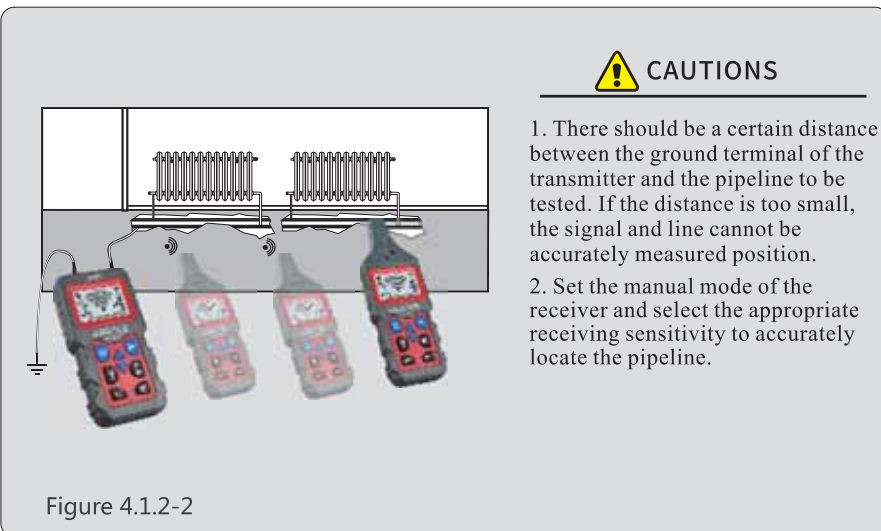

Figure 4.1.2-2

4.1.3 Detect user allocation of three-phase power supply lines on the same floor

When detecting the user allocation of three-phase power supply lines on the same floor, please take the following steps:

- Disconnect the main switch in the distribution box of the floor;
- Remove the connection of the neutral line in the distribution box of this floor with the neutral line of other floors;
- Connect the positive pole of the transmitter to the three-phase electric phase line to be tested, and the negative pole to ground, as shown in Figure 4.1.3-1;
- Operate the instrument in accordance with the cable routing method;
- After setting up the transmitter, take the receiver to the air switch at the residence for detection. If the signal can be received, the residence circuit is connected to the test phase line, otherwise it is not.

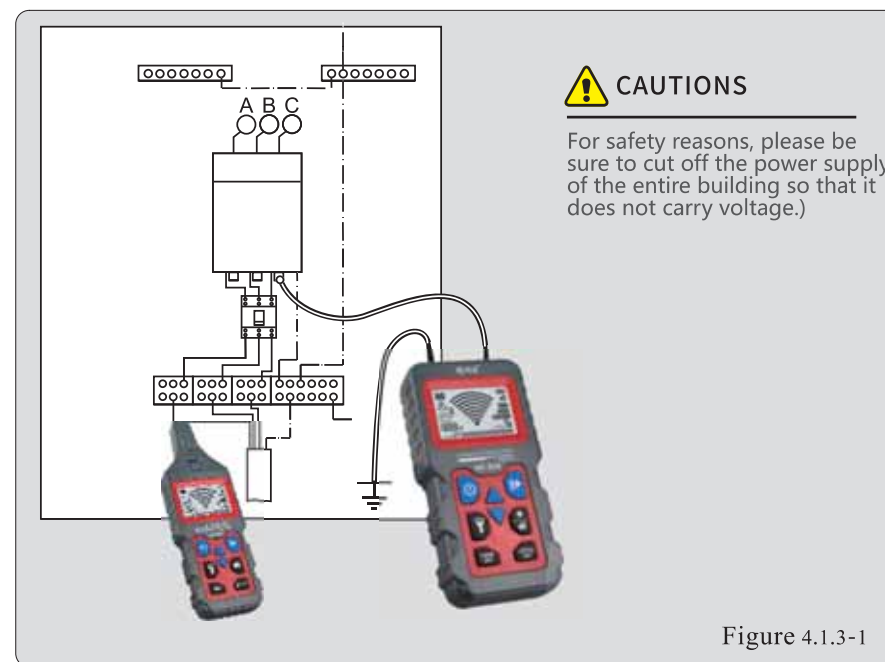
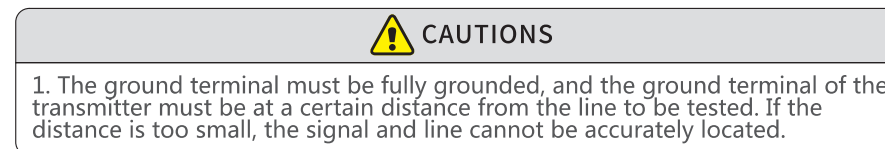

Figure 4.1.3-1



4.1.4 Find the fuse corresponding to the line

In a multi-family building, use any socket L and N to connect to the transmitter (as shown in Figure 4.1.4-1), and set the transmitter's transmit power to an appropriate level. Prerequisites:

- Disconnect all air switches or leakage switches in the distribution box
- According to the bipolar application-non-energized connection method 3, connect the positive pole of the transmitter to the live wire of the socket, and the negative pole of the transmitter to the neutral wire (the accessory of this example uses a test pen, which is easy to plug into the socket) as shown in Figure 4.1.4-1 :
- Adopt manual sensitivity mode to reduce the receiver sensitivity to a suitable level, and detect near the air switch or leakage switch fuse.

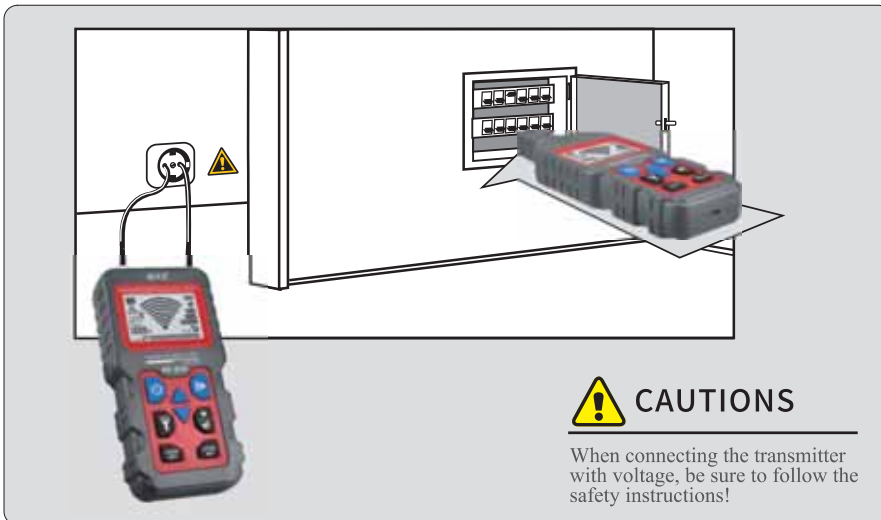

CAUTIONS

1. In the search process, the fuse with the strongest and most stable signal is the target to be searched. Since the signal will crosstalk to other lines, the receiver may also have a signal on other fuses, but the signal is relatively weak.
2. When detecting, it is best to place the probe of the detector at the inlet of the fuse box. This method has a better detection effect.

4.2 Example of finding cable break point:

4.2.1 Use two transmitters to find cable break-point failure

When there are many wiring harnesses and some of the wiring harnesses cannot be grounded, only one transmitter is used to connect a signal from one end of the line to find the line short-circuit fault. Due to the electric field crosstalk, only a rough location can be performed, and the open-circuit fault point cannot be accurately located. At this time, two transmitters can be used to connect signals from both ends of the line to find the fault point of the open circuit (the second transmitter needs to be ordered separately).

Methods as below:

- The circuit must be uncharged;
- According to the unipolar connection method, connect the positive pole of transmitter 1 to one end of the cable to be tested and the negative pole to ground; connect the positive pole of transmitter 2 to the other end of the cable to be tested, and the negative pole to ground. The remaining unused lines must be grounded as shown in Figure 4.2.1-1;
- Set the transmitter 1 signal code to F, and the transmitter 2 signal code to C (the signal code is not specific, just make sure that the transmitter 1 and transmitter 2 signal codes are inconsistent)
- Set the receiver sensitivity, and detect along the target cable path, observe the signal code received by the receiver, when the code changes from F to C or C to F, the detection area is the area where the open circuit fault is located. The receiver sensitivity can be reduced for precise positioning.

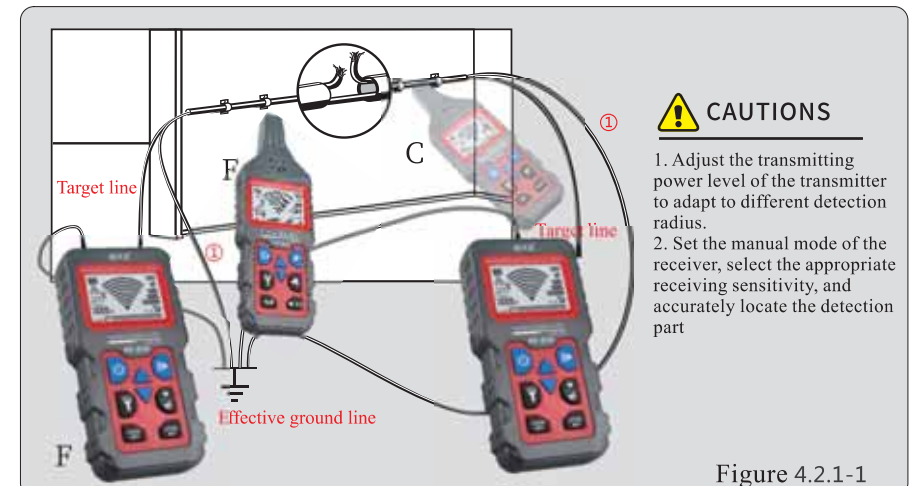

CAUTIONS

1. The grounding terminal must be fully grounded.
2. The contact resistance of the line interruption must be greater than 100 kilohms.

4.2.2 Find the open circuit fault in the electric floor heating

- The circuit must be without voltage;
- Connect the positive pole of the transmitter to the floor heating cable and the negative pole to ground according to the wiring method of the unipolar application in the figure. The specific connection method is as shown in the figure below. Method 1 is shown in Figure 4.2.2-1. 2. As shown in Figure 4.2.2-2, the test method refers to 4.2.1 Use two transmitters to find cable breakpoints.

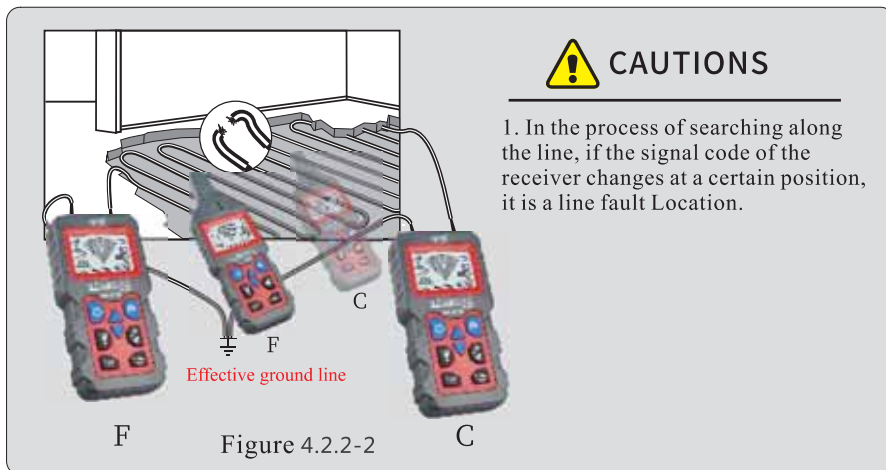
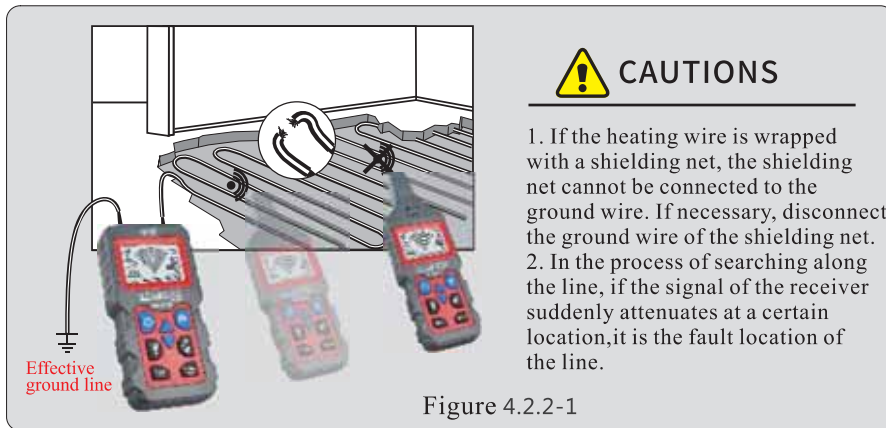

4.3 Finding blockages in buried non-metallic pipes

Prerequisites:

- The pipe must be made of non-conductive materials (such as plastic pipe);
- The pipeline line must be without voltage;
- The transmitter is connected with a metal spiral tube (metal hose) and an auxiliary ground wire as shown in the figure;
- Refer to the cable breakpoint method to set up the transmitter, and use the receiver to detect along the laying path and observe the receiver signal. If the signal suddenly attenuates in a certain area, the area is a blockage point.

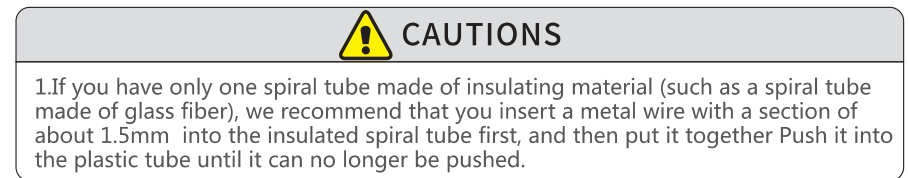
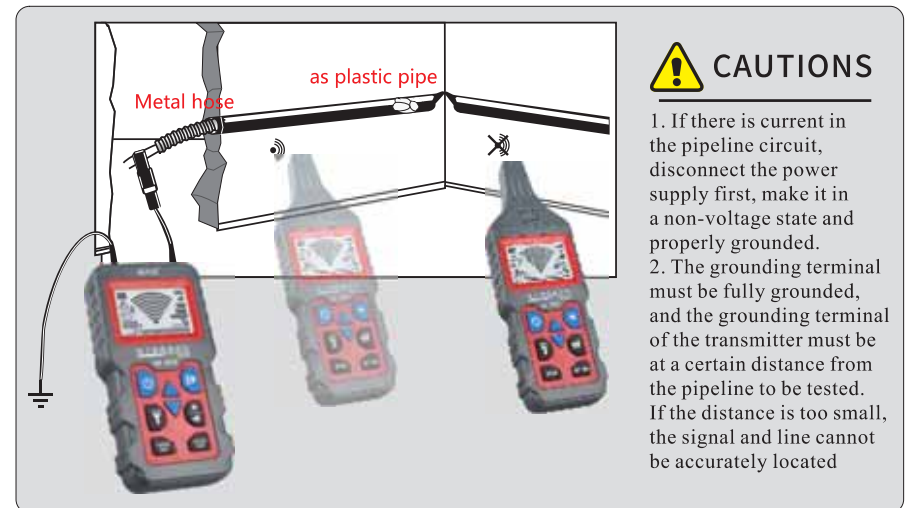

4.4 Classification or determination of the laid line

Prerequisites:

- The circuit must be without voltage;
- The ends of the core wires must be twisted to each other and can conduct electricity to each other;
- Connect the transmitter as shown in Figure 4.4-1;
- The measurement method is the same as the example.

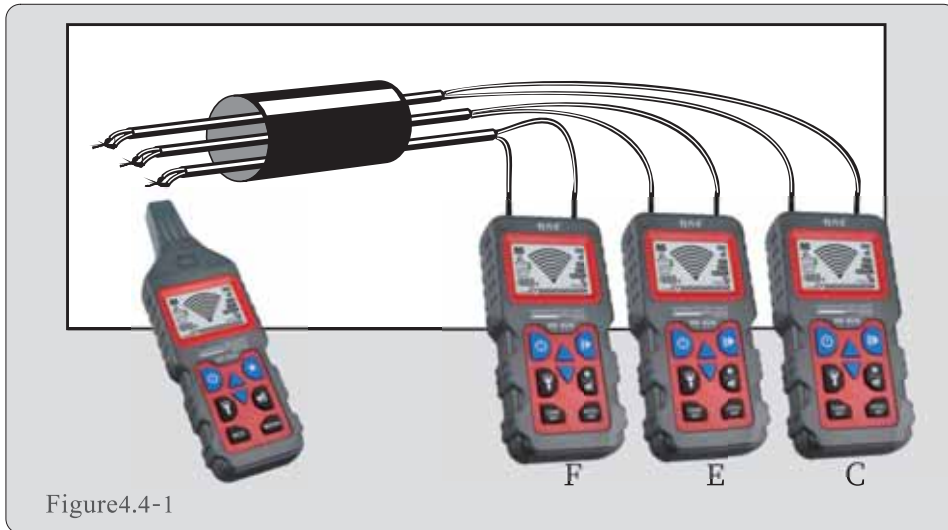

CAUTIONS

1. If there is current in the cable, disconnect the power supply first to make it in a non-voltage state.
2. The ends of the core wires with the insulation layer removed must be conductive to each other, and the ends of the core wires with the insulation layer removed must be twisted with each other.
3. If there is only one transmitter available for use, it is necessary to perform multiple measurements by changing the connection between the transmitter and the core wire of the cable.

HINTS

1. When changing the connection between the transmitter and the cable core, you can change the transmitter's transmission code to distinguish different lines.
2. Adjust the transmitting power level of the transmitter to adapt to different detection radius.
3. If necessary, you can purchase transmitters with different transmitting signals.

5. Methods to improve the depth of detection

In bipolar applications, if the core wire in a multi-core cable is used as the return wire (such as NYM3x1.5mm²), the detection depth will be greatly limited. The reason is that the feeder and the loop are very close, which causes serious distortion of the magnetic field. It is not possible to establish a sufficiently strong magnetic field in the narrow part. If a separate loop is used, this problem will be easily resolved. A separate conductor allows the magnetic field to spread more strongly. The return wire can be any wire or cable reel. It is important that the distance between the feeder line and the return line is greater than the buried depth. In actual work, it is often 2 meters or more.

Prerequisites:

- The circuit must be without voltage;
- Connect the transmitter as shown in Figure 5.1-1;
- The distance between the feeder line and the return line must be at least 2 to 2.5 meters or more;
- The measurement method is the same as the example.

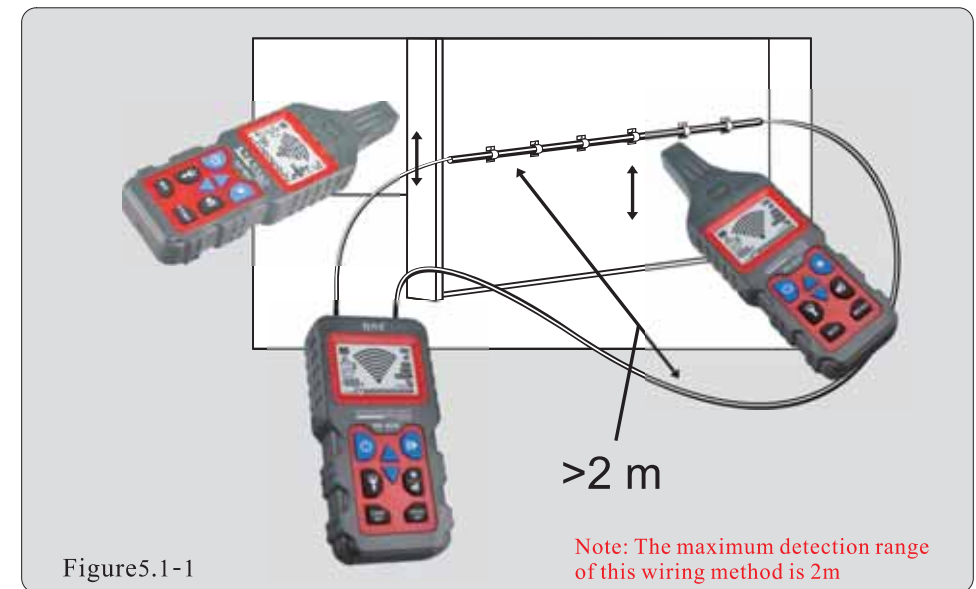

5.2 Methods to improve the effective radius of the live line search

When the transmitter is directly connected to the phase line and the neutral line, the signal is conducted on two parallel lines (as shown in Figure 5.2-1). The twisting of the lines can sometimes cause the signals to cancel each other. The effective radius in this case The maximum is only 0.5 meters. In order to eliminate this effect, the wiring should be as shown in Figure 5.2-2. A separate cable is used for the return line, which can increase the effective radius to 2.5 meters or higher. A larger distance return line can be provided through the cable reel. (See Figure 5.2-2).

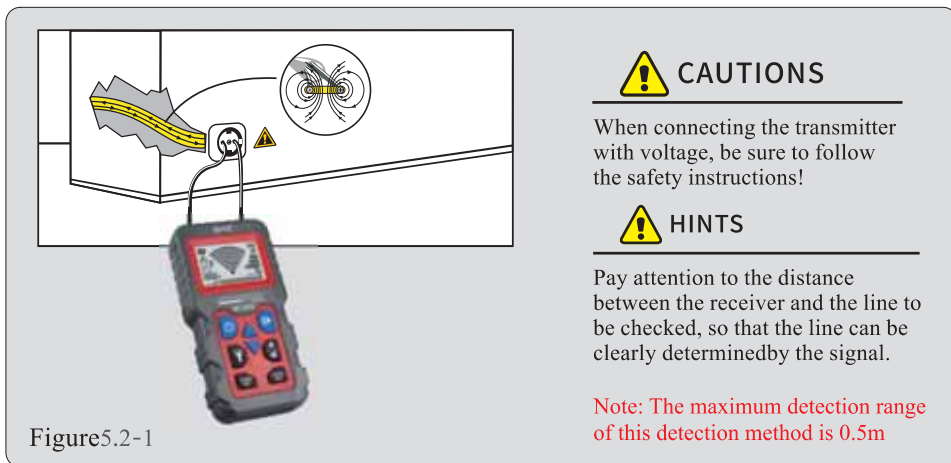

Figure 5.2-1

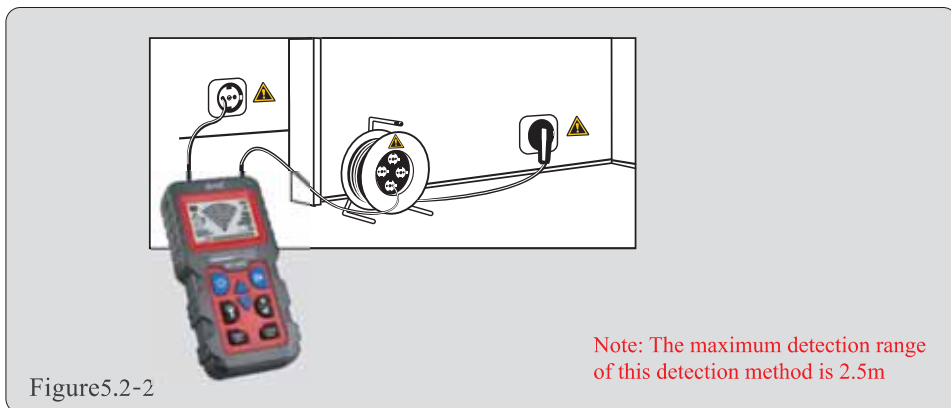

Figure 5.2-2

6. Technical parameters

Technical parameters of transmitter	Output signal	125kHz	
	External voltage identification range	DC 12~400V $\pm 2.5\%$; AC 12~400V(50~60Hz) $\pm 2.5\%$	
	Display	LCD, with function display and column chart	
	External voltage's dielectric strength	Max. 400V AC/DC	
	Overvoltage type	CAT III 300V	
	pollution degree	2	
	Power supply	3.7V 1400 mAh Lithium battery	
	Power consumption	MIN current	80mA
		MAX current	300mA
	Fuse	F 0.5 A 500V, 6.3x32 mm	
Range of temperature	In work	0°C ~ 40 °C, with maximum relative humidity of 80% (non-condensation)	
	In storage	-20°C ~ 60°C, with maximum relative humidity of 80% (non-condensation)	
Altitude	Max. 2000m		
Dimensions (HxWxD)	156 x 80 x 32 mm		
Weight	235g with battery		

Technical parameters of receiver	Depth of tracking	The depth of tracking depends on the material and specific applications		
	Cable locating mode	Single pole application	About 0~1m	
		Dual-pole application	About 0-0.5m	
		Single loop line	Up to 2.5m	
	Grid voltage identification	About 0~0.4m		
	Display	LCD, with function display and column chart		
	Power supply	3.7V 1400 mAh Lithium battery		
	Power consumption	MIN current	100mA	
		MAX current	300mA	
	Range of temperature	In work	0°C ~ 40°C, with maximum relative humidity of 80% (non-condensation)	
In storage		-20°C ~ +60°C, with maximum relative humidity of 80% (non-condensation)		
Altitude	Max. 2000m			
Dimensions (HxWxD)	226 x 73 x 29 mm			
Weight	235g with battery			

7. Repair and maintenance

- 1.If the detector is suspected of malfunctioning , please confirm that the electrical amperage of the battery is sufficient and the test lead is not broken.
- 2.Before sending back the detector for repair, please dismantle the battery and describe the phenomenon of malfunction,and then properly pack the apparatus to avoid damaging it during transportation. For damages caused during transportation, the company would assume no responsibility.
- 3.There is a fuse within the transmitter. If it is damaged during the guarantee period, it can only be replaced by technical personnel of the company. If it is damaged after the guarantee period, please replace it with a fuse of the same model by yourself. This fuse is single metal wire fast-melting type, so do not replace it with a helical metal wire of delayed type, otherwise the transmitting power and safety of apparatus cannot be guaranteed.

7.1 Troubleshooting

If the detector does not work properly, please check the items in the table below:

Malfunction	Items to be checked	Measures to be taken
Can not turn on the machine	Has the battery been installed?	Install new batteries
	Is the electrical amperage of the battery too low?	
	Is the polarity of the battery correct?	Check the polarity
Transmitter cannot identify external voltage	Is the contact sound?	Reconnect the line
	Is the probe broken?	Replace the probe
	Has the probe been inserted to the bottom?	Properly insert the probe
	Is the test lead broken?	Replace the test lead
	Has the test lead been inserted to the bottom?	Property insert the test lead
Power supply is cut off during measuring	Is the electrical amperage of battery sufficient?	Replace the battery
	Did the machine automatically turn off ?	Turn on the machine again
The transmitter cannot receive the signals transmitted by itself	Has the transmission button been pressed?	Transmit again
	Is the fuse of transmitter broken?	Send it back to a closest service center

7.2 Checking of the fuse of the transmitter

The fuse of the transmitter can prevent the transmitter from being damaged by overload or wrong operations. If the fuse in the transmitter has already been melted down, the transmitter can only transmit weak signals. If the self-check of transmitter is passed but the signal transmitted is weak, it means that the transmission is sound but the fuse has been melted down. If no signal is found during the transmission status self-check of the transmitter, and the voltage of battery is normal, it means that the transmitter is broken and should be repaired by special technicians.

Specific methods and steps to check the fuse of the transmitter:

- 1) Break all the measuring circuits of the transmitter;
- 2) Turn on the transmitter and put it in the transmitting status;
- 3) Set the transmitting power of transmitter to level I;
- 4) Connect one end of the test lead to the joint①of the transmitter;
- 5) Insert the other end of test lead into the connecting socket of the transmitter;
- 6) Turn on the transmitter to search for the signals from the test lead, and move the probe of the receiver towards the test lead;
- 7) If the fuse is not broken, the value displayed on the receiver will be doubled.

7.3 Cleaning

Use a rag dipped with clean water or neutral detergent to wipe the transmitter, and then use a dry rag to wipe it again.



CAUTIONS

- 1.Before cleaning work, please make sure that the equipment has been turned off, and all the circuits have been cut off.
- 2.During cleaning work, please do not use benzene, alcohol, acetone, ether, ketone, thinner or gasoline, which would make the equipment deformed or decolorated.
- 3.After cleaning, use the equipment again when it is completely dry.

8. Accessories

Transmitter	1pc	Grounding rod	1pc
Receiver	1pc	Carry bag	1pc
Test Lead	1pc for each color (Red/black)	User manual	1pc
Crocodile clamps	1pc for each color (Red/black)	Color box	1pc
Test probe	1pc for each color (Red/black)	Built-in battery	2pc

设计	品名	样式	印刷要求
吴碧琴	NF-826说明书-英文V2	骑马钉	彩色
日期	品号	页码	
2021.12.29	304-E0701-0014	32P	
样品	尺寸	材质	
	104x145mm	128G双铜纸	
变更记录	V2相较于V1简化操作步骤		