

## SA40-18SRWA

101.2 mm (4.0 inch) Single Digit Numeric Display

### DESCRIPTIONS

- The Super Bright Red source color devices are made with Gallium Aluminum Arsenide Red Light Emitting Diode
- Electrostatic discharge and power surge could damage the LEDs
- It is recommended to use a wrist band or anti-electrostatic glove when handling the LEDs
- All devices, equipments and machineries must be electrically grounded

### FEATURES

- Large size
- 4.0 inch digit height
- Low current operation
- Excellent character appearance
- High light output
- Easy mounting on P.C. boards or sockets
- Mechanically rugged
- Standard: gray face, white segment
- RoHS compliant

### APPLICATIONS

- Home and smart appliances
- Display time and digital combination
- Industrial and instrumental applications
- Numeric status

### ATTENTION

Observe precautions for handling electrostatic discharge sensitive devices



### PACKAGE DIMENSIONS

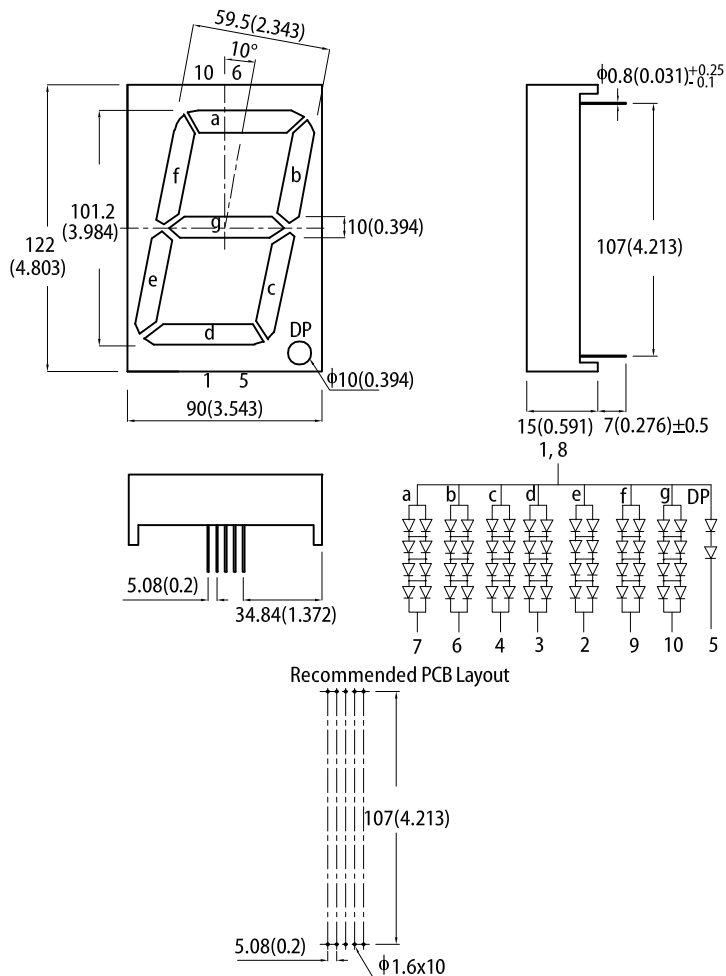

Notes:  
 1. All dimensions are in millimeters (inches), Tolerance is  $\pm 0.25(0.01)$  unless otherwise noted.  
 2. The specifications, characteristics and technical data described in the datasheet are subject to change without prior notice.

### SELECTION GUIDE

Part Number	Emitting Color (Material)	Lens Type	Iv (ucd) @ 10mA <sup>[1]</sup>		Description
			Min.	Typ.	
SA40-18SRWA	■ Super Bright Red (GaAlAs)	White Diffused	52000	120000	Common Anode, Rt. Hand Decimal
			*14000	*29000	

Notes:  
 1. Luminous intensity / luminous flux: +/-15%.  
 \* Luminous intensity value is traceable to CIE127-2007 standards.

**ELECTRICAL / OPTICAL CHARACTERISTICS at T<sub>A</sub>=25°C**

Parameter	Symbol	Emitting Color	Value		Unit
			Typ.	Max.	
Wavelength at Peak Emission I <sub>F</sub> = 10mA	λ <sub>peak</sub>	Super Bright Red	655	-	nm
Dominant Wavelength I <sub>F</sub> = 10mA (DP)	λ <sub>dom</sub> <sup>[1]</sup>	Super Bright Red	640	-	nm
Spectral Bandwidth at 50% Φ REL MAX I <sub>F</sub> = 10mA	Δλ	Super Bright Red	20	-	nm
Capacitance	C	Super Bright Red	45	-	pF
Forward Voltage I <sub>F</sub> = 20mA (Segment) Forward Voltage I <sub>F</sub> = 10mA (DP)	V <sub>F</sub> <sup>[2]</sup>	Super Bright Red	7.2 3.6	9.2 4.6	V
Reverse Current (V <sub>R</sub> = 5V) (Per chip)	I <sub>R</sub>	Super Bright Red	-	10	μA

## Notes:

1. The dominant wavelength (λ<sub>d</sub>) above is the setup value of the sorting machine. (Tolerance λ<sub>d</sub> : ±1nm. )
2. Forward voltage: ±0.1V.
3. Wavelength value is traceable to CIE127-2007 standards.
4. Excess driving current and / or operating temperature higher than recommended conditions may result in severe light degradation or premature failure.

**ABSOLUTE MAXIMUM RATINGS at T<sub>A</sub>=25°C**

Parameter	Symbol	Value	Unit
Power Dissipation (Per chip)	P <sub>D</sub>	75	mW
Reverse Voltage (Per chip)	V <sub>R</sub>	5	V
Junction Temperature	T <sub>j</sub>	115	°C
Operating Temperature	T <sub>op</sub>	-40 to +85	°C
Storage Temperature	T <sub>stg</sub>	-40 to +85	°C
DC Forward Current (Segment) DC Forward Current (DP)	I <sub>F</sub>	60 30	mA
Peak Forward Current (Segment) Peak Forward Current (DP)	I <sub>FM</sub> <sup>[1]</sup>	310 155	mA
Electrostatic Discharge Threshold (HBM)	-	3000	V
Lead Solder Temperature <sup>[2]</sup>		260°C For 3-5 Seconds	

## Notes:

1. 1/10 Duty Cycle, 0.1ms Pulse Width.
2. 2mm below package base.
3. Relative humidity levels maintained between 40% and 60% in production area are recommended to avoid the build-up of static electricity – Ref JEDEC/JESD625-A and JEDEC/J-STD-033.

### TECHNICAL DATA

#### RELATIVE INTENSITY vs. WAVELENGTH

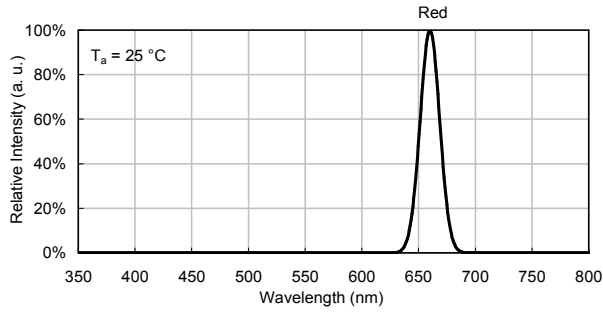

### SUPER BRIGHT RED (SEGMENT)

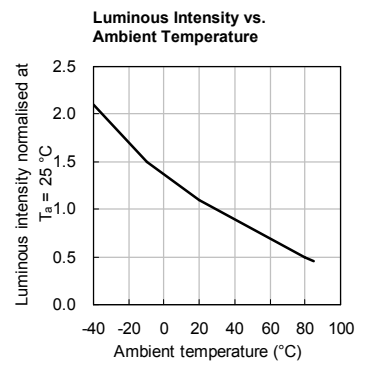
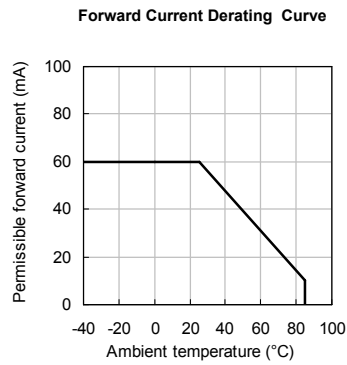
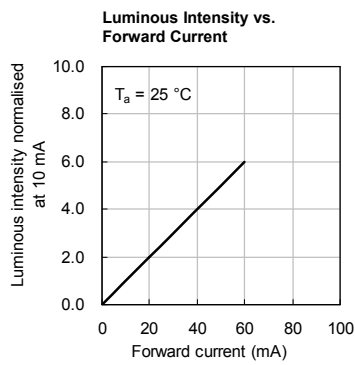
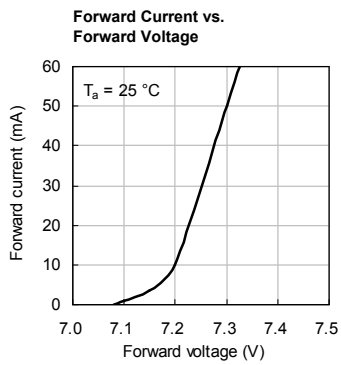

### SUPER BRIGHT RED (DP)

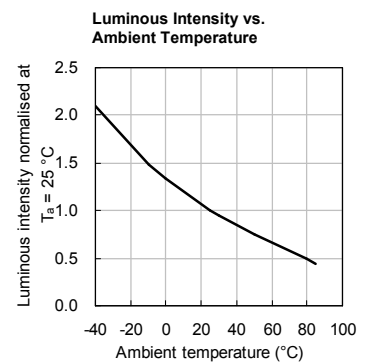
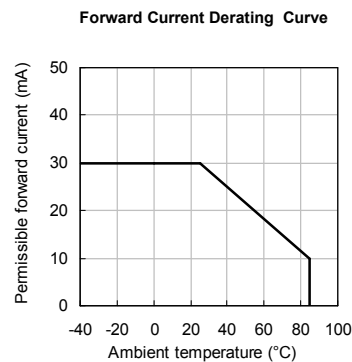
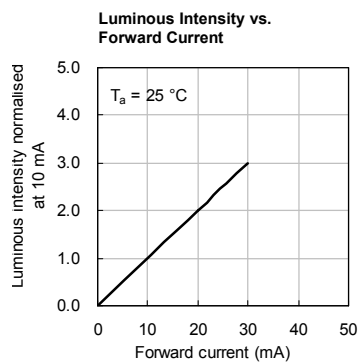
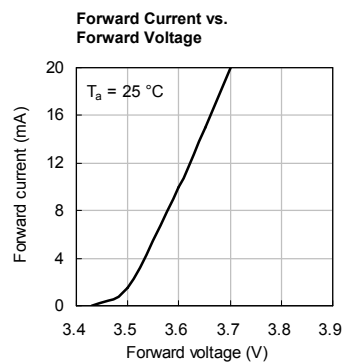

## RECOMMENDED WAVE SOLDERING PROFILE

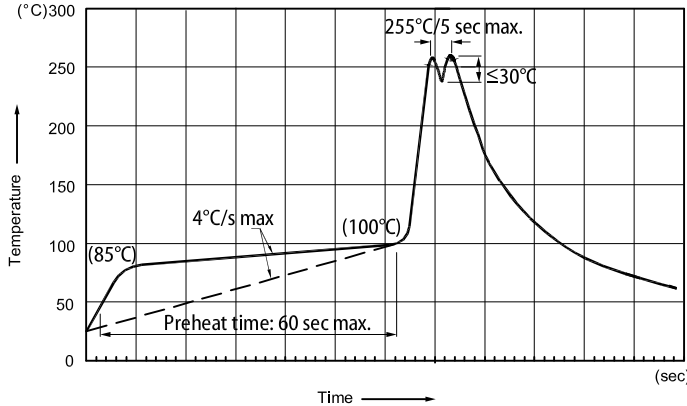

- Notes:**
1. Recommend pre-heat temperature of 105°C or less (as measured with a thermocouple attached to the LED pins) prior to immersion in the solder wave with a maximum solder bath temperature of 260°C
  2. Peak wave soldering temperature between 245°C ~ 255°C for 3 sec (5 sec max).
  3. Do not apply stress to the epoxy resin while the temperature is above 85°C.
  4. Fixtures should not incur stress on the component when mounting and during soldering process.
  5. SAC 305 solder alloy is recommended.
  6. No more than one wave soldering pass.
  7. During wave soldering, the PCB top-surface temperature should be kept below 105°C.

## Soldering General Notes

1. Through-hole displays are incompatible with reflow soldering.
2. If components will undergo multiple soldering processes, or other processes where the components may be subjected to intense heat, please check with Kingbright for compatibility.

## CLEANING

1. Mild "no-clean" fluxes are recommended for use in soldering.
2. If cleaning is required, Kingbright recommends to wash components with water only. Do not use harsh organic solvents for cleaning because they may damage the plastic parts.
3. The cleaning process should take place at room temperature and the devices should not be washed for more than one minute.
4. When water is used in the cleaning process, immediately remove excess moisture from the component with forced-air drying afterwards.

## THROUGH HOLE DISPLAY MOUNTING METHOD

### Lead Forming

1. Do not bend the component leads by hand without proper tools. The leads should be bent by clinching the upper part of the lead firmly such that the bending force is not exerted on the plastic body.

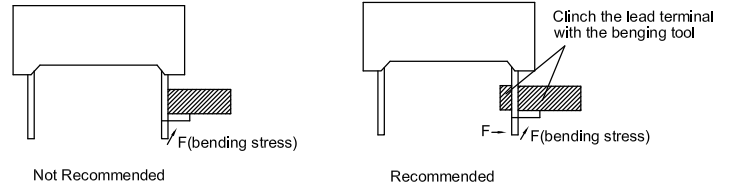

### Installation

1. The installation process should not apply stress to the lead terminals.
2. When inserting for assembly, ensure the terminal pitch matches the substrate board's hole pitch to prevent spreading or pinching the lead terminals. (Fig.1)
3. The component shall be placed at least 5mm from edge of PCB to avoid damage caused excessive heat during wave soldering. (Fig.2)

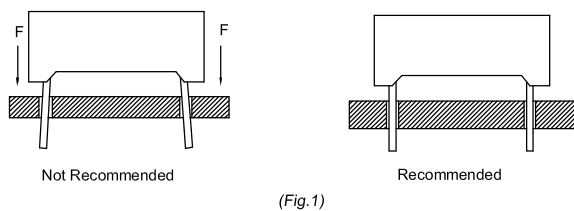

(Fig.1)

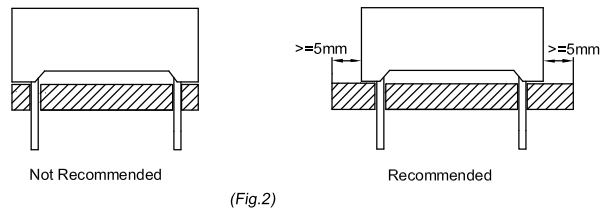

(Fig.2)

## CIRCUIT DESIGN NOTES

1. Protective current-limiting resistors may be necessary to operate the LEDs within the specified range.
2. LEDs mounted in parallel should each be placed in series with its own current-limiting resistor. (Fig.3)
3. The driving circuit should be designed to protect the LED against reverse voltages and transient voltage spikes when the circuit is powered up or shut down.
4. The safe operating current should be chosen after considering the maximum ambient temperature of the operating environment.
5. Prolonged reverse bias should be avoided, as it could cause metal migration, leading to an increase in leakage current or causing a short circuit.

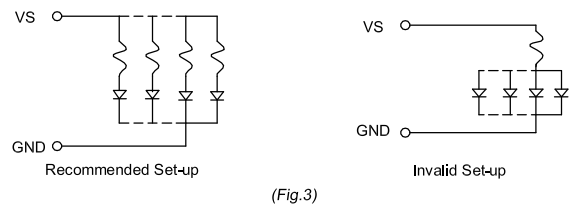

(Fig.3)

### PACKING & LABEL SPECIFICATIONS

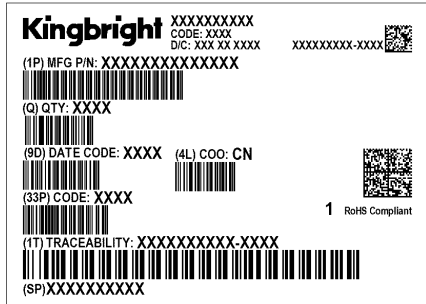
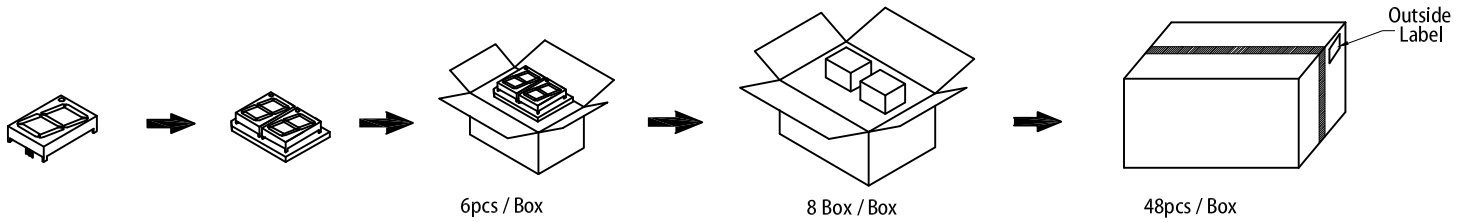

### PRECAUTIONARY NOTES

1. The information included in this document reflects representative usage scenarios and is intended for technical reference only.
2. The part number, type, and specifications mentioned in this document are subject to future change and improvement without notice. Before production usage customer should refer to the latest datasheet for the updated specifications.
3. When using the products referenced in this document, please make sure the product is being operated within the environmental and electrical limits specified in the datasheet. If customer usage exceeds the specified limits, Kingbright will not be responsible for any subsequent issues.
4. The information in this document applies to typical usage in consumer electronics applications. If customer's application has special reliability requirements or have life-threatening liabilities, such as automotive or medical usage, please consult with Kingbright representative for further assistance.
5. The contents and information of this document may not be reproduced or re-transmitted without permission by Kingbright.
6. When any special process such as potting is required for LED assembly, please consult with Kingbright representative before proceeding.
7. All design applications should refer to Kingbright application notes available at <https://www.KingbrightUSA.com/ApplicationNotes>