

Overview

The WiFi smart switches with 1-3 gangs are divided into T0(EU & UK &US), T1(EU & UK), T2(EU & UK &US) and T3(EU & UK &US). T3 is available in black, and T0, T1 and T2 are available in white. Additionally T1, T2 and T3 support 433MHz remote controller to control.

All switches can be controlled remotely using your phone, and devices connected with switches can work independently. Works with Amazon Alexa and Google Assistant which let you turn on or off your appliances with a voice command, perfect for those need to handle much housework simultaneously. Features sensitive touch buttons that are attached on the simple and stylish switches to ensure a modern and nice decoration on any wall surface. A slight tap for easier control. If worry your monthly electricity bill is overwhelmed by power-hungry appliances, or want to turn on your coffee maker while you're sitting on the sofa, the time schedule is a good choice. Set a time for devices and the switches will help you turn on or off them automatically. Tailor smart scene for your appliances. Simply set an event to happen to trigger one SONOFF device or groups of devices with a tap on your phone. Your devices will not run because of an abnormal WiFi network, the LAN control hence is designed to make sure they can work normally.

Compatible with IFTTT function, the switches can communicate with a slew of devices and services, to trigger them on or off. There are several complicated steps when we start to access a smart home, to pair, enter account and password, name and so on. The share control provides you a quick way to allow you and your family to control devices together. You're not sure whether turning off the heater when leaving home, just take your phone out and open the eWeLink app to check the real-time device status.

T0 Series

1-3 Gang, White, WiFi Control

EU



UK



US (Border)



T1 Series

1-3 Gang, White, WiFi & RF Control

EU



UK



T2 Series

1-3 Gang, White, WiFi & RF Control

EU (Border)



UK (Border)



US (Border)



T3 Series

1-3 Gang, Black, WiFi & RF Control

EU (Border)









UK (Border)



US (Border)



Compare TX Models

	T0	T1	T2	T3
433MHZ	—	✓	✓	✓
1Gang	✓	✓	✓	✓
2Gang	✓	✓	✓	✓
3Gang	✓	✓	✓	✓
EU	 white	 white	 white	 black
UK	 white	 white	 white	 black
US	 white	—	 white	 black

* No a border on the T0 & T1 (EU&UK) panel. T2 & T3 with a border.
All US series with a border

SONOFF TX

Wi-Fi Smart Wall Switch



APP Control



Timing Schedules



Voice Control



Share Control



Sync Status



Touch Control



LED Backlight



Smart Scene

APP Remote Control

Just tap on eWeLink App to turn on a light anytime and anywhere
A lighted house anticipates your arrival

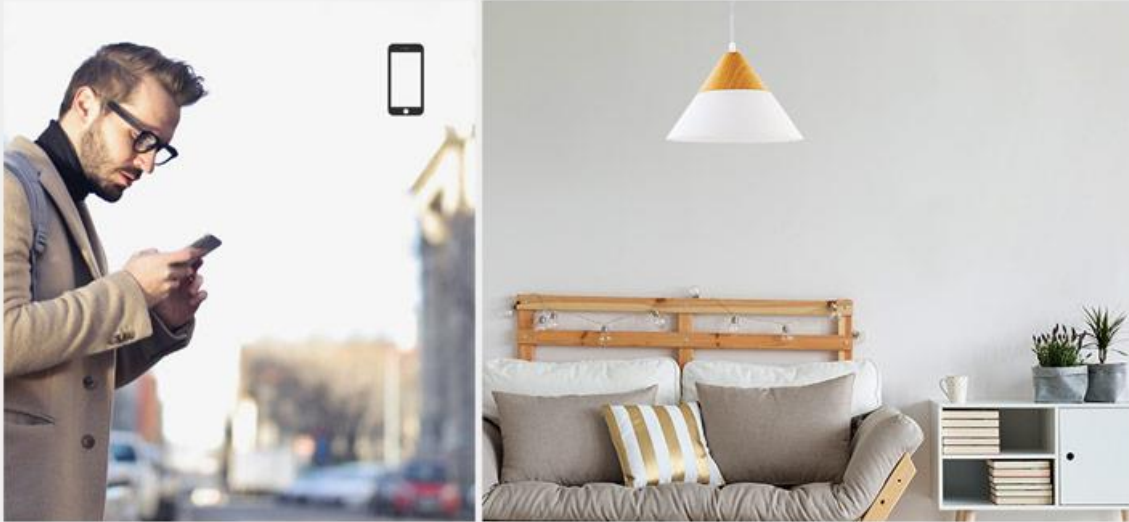

Share Control

Share control of your home appliances to your family or friends so that they
can also control the devices remotely

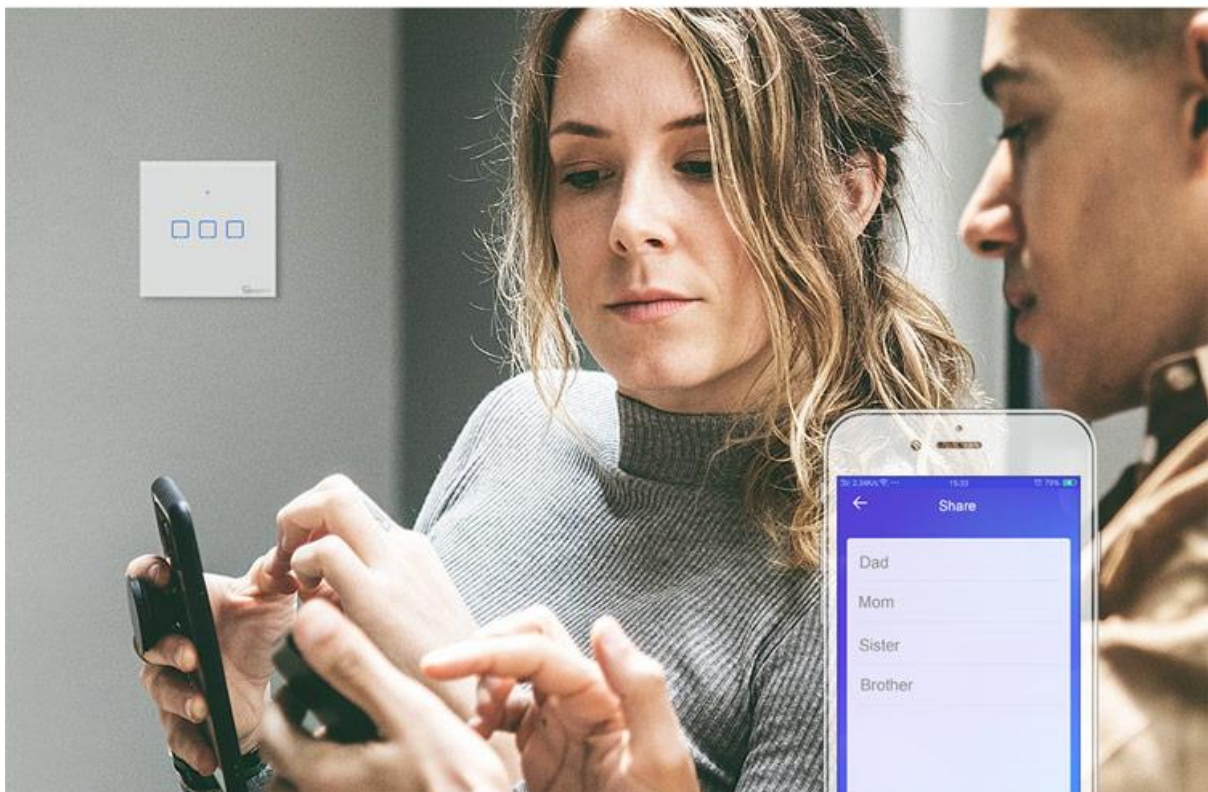

Hands-free Voice Control

Compatible with Alexa & Google Home, the smart switch allows you to control lights on/off with your voice

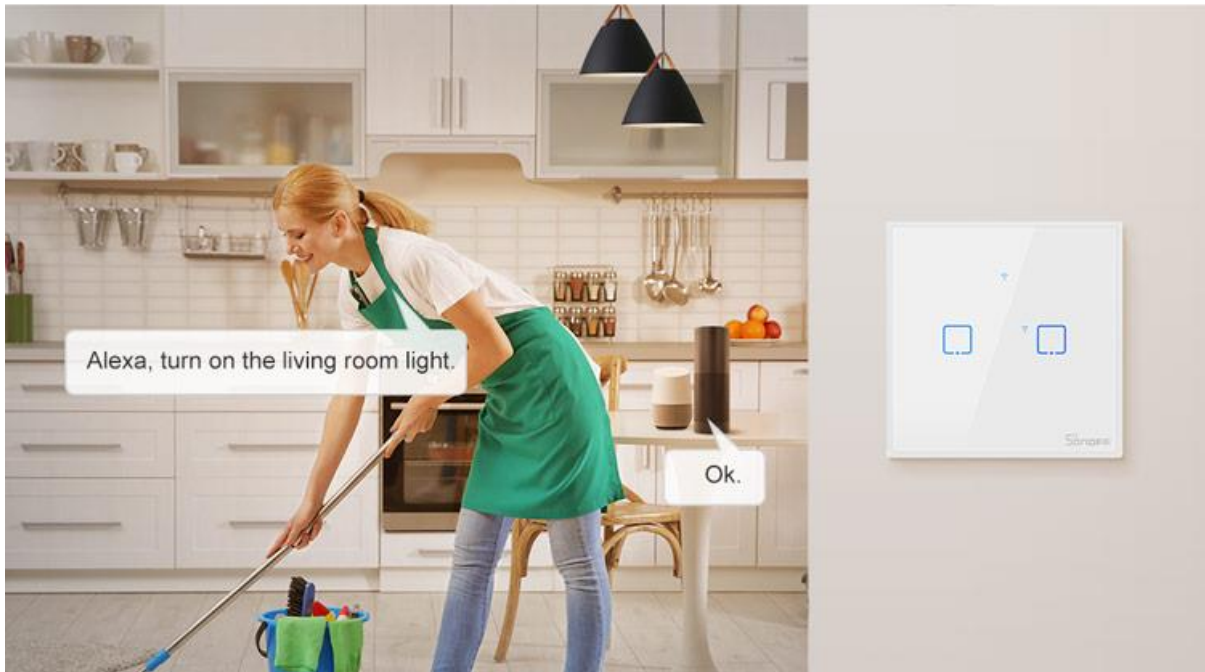

Sync Status

Real-time device status can be provided on eWeLink App in order that you can track status change of your devices



Smart Scene

Create smart scenes to make one SONOFF device trigger on/off another one, or group multiple devices to control them with one tap

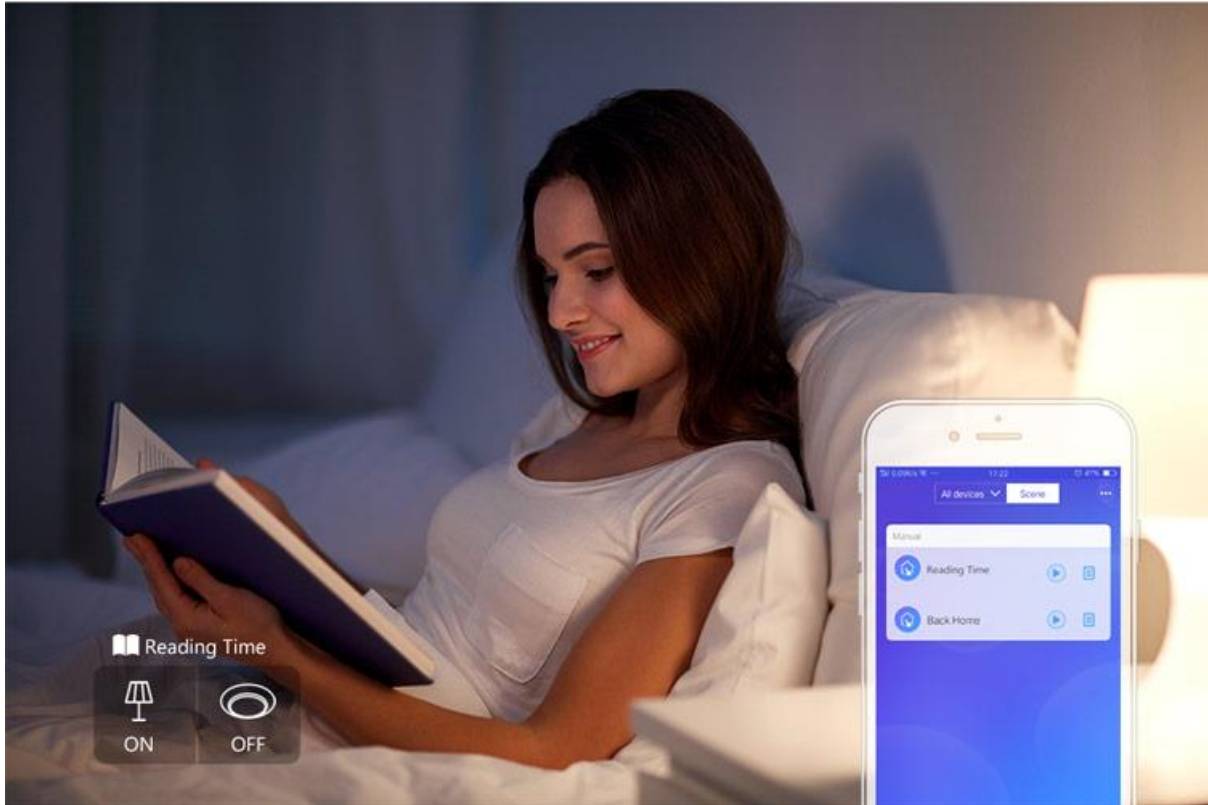

Toughened Glass Panel Design

Waterproof, fireproof, and easy-to-clean toughened glass panel & PC shell design not only decorate your house, but also feel smooth like a mobile phone screen



Easy to Clean



Toughened Glass Panel



The sensitive touch buttons are nearly invisible when it's not installed, and in 90% brightness in use and 30% brightness on the standby mode. Easy to locate but less bothering in the night.

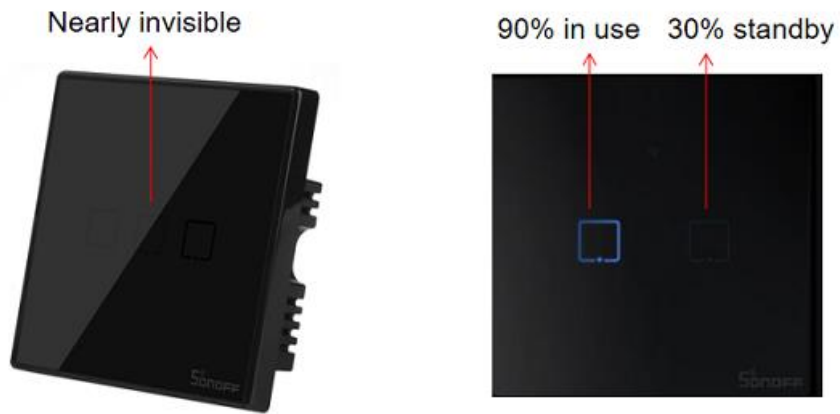

EU

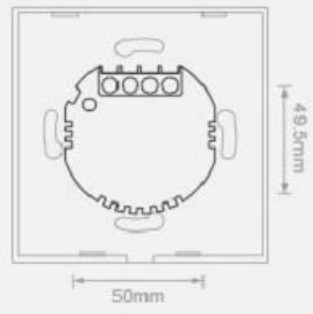
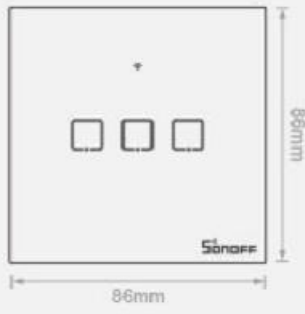

UK

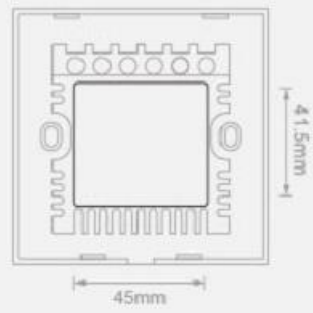
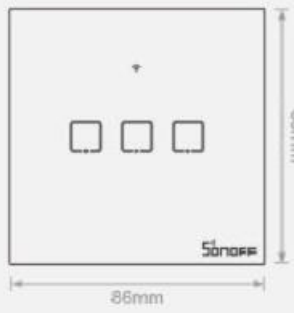

US

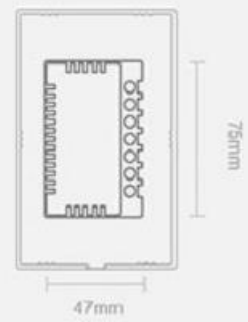

Wiring Diagram

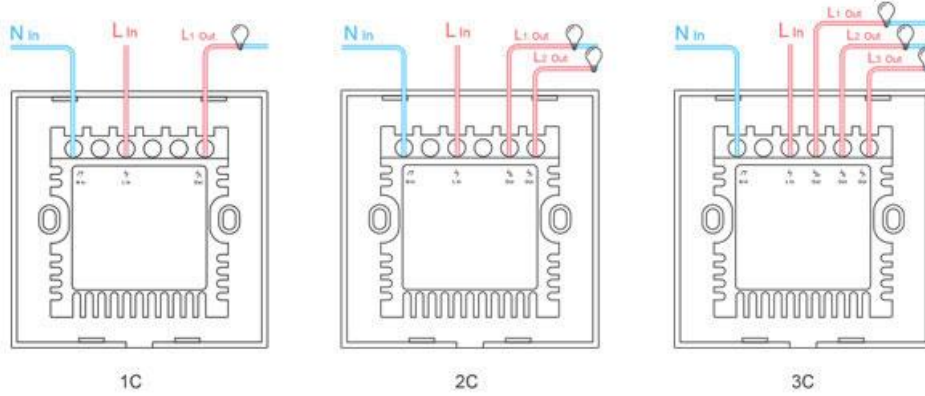

NOTE: Neutral wire is required

Quick Start

