

IC Series Pure Sine Wave Inverter (High Frequency) User Manual

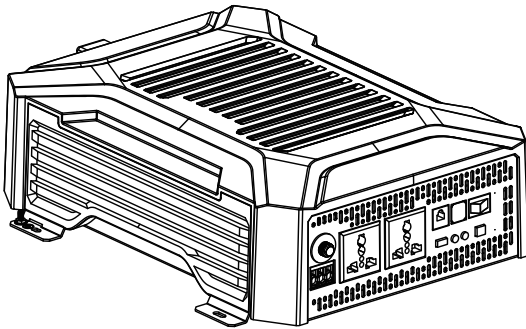

Dear user:

Thank you very much for choosing our product !

Important safety instructions

Please keep this manual for future reference

This manual contains all safety, installation and operating instructions for the IC Series pure sine wave inverter (high frequency) (hereinafter referred to as "the Inverter"). Please read all instructions and precautions in the manual carefully before installation and use.

- 1. Non-safety voltage exists inside the inverter. To avoid personal injury, users shall not disassemble the inverter themselves. Please contact our professional maintenance personnel for repair.
- 2. Do not place the inverter within the reach of children.
- 3. Do not install the inverter in harsh environments such as moist, oily, flammable or explosive, or heavily dusty areas.
- 4. The AC output of the inverter is high voltage, so please do not touch the wiring terminals.
- 5. The housing of the inverter is super hot when it is working. Do not touch it and keep away from materials or equipment affected by high temperature.
- 6. Do not open the terminal protective cover when the inverter is working.
- 7. Make sure to disconnect the fuse or circuit breaker near the terminals of the battery and AC output before installing and adjusting the wiring of the inverter.
- 8. After installation, check whether all wiring is tightly connected to avoid the danger of heat accumulation due to loose connection.
- 9. The inverter is off-grid. It is necessary to confirm that it is the only input device for load, and it is forbidden to use it in parallel with other input AC power to avoid damage.
- 10. In order to ensure that users can protect their personal and property safety while using this product, relevant information is highlighted in the manual with following symbols. The following symbols in the manual indicate that you should read the relevant words carefully.



Warning: Electric shock that may damage devices or electrocution/injury if it is not avoided.



Caution: Potential dangers that may damage devices if they are not avoided.



Note: Important notices in operation that may trigger the device fault alarm if they are not performed.

Contents

1. Introduction	03
1.1 Product overview	03
1.2 Product features	03
1.3 Appearance and interface description	04
1.4 Dimension drawing	04
2. Specification	05
3. Description of interface function	06
3.1 RS485 communication	06
3.2 USB interface	06
3.3 TTL communication interface	06
3.4 Operating mode switch	07
3.5 LED indicator/buzzer	07
3.6 External switch contact interface	08
3.7 Bluetooth communication	08
3.8 CAN communication (optional)	08
4. Installation instructions	09
4.1 Installation precautions	09
4.2 Wiring specifications and circuit breaker selection	09
4.3 Installation and wiring	10
5. Protection function	12
5.1 Input of over-voltage protection	12
5.2 Input of low-voltage protection	12
5.3 Output of overload protection	12
5.4 Output of short-circuit protection	13
5.5 Over-temperature protection of device	13
5.6 Fault protection of fan	13
6. Common problems and solutions	13
7. System maintenance	14

1. Introduction

1.1 Product overview

Thanks to the full-digital intelligent control technology and voltage-current double closed-loop control algorithm adopted, IC Series pure sine wave inverter (high-frequency) has a fast dynamic response, high conversion efficiency, low harmonic component and stable operation. With idle mode, normal mode and energy saving mode optional, the IC Series can maximize battery energy saving based on application scenarios and requirements.

Key components with high power density and long service life provide this IC Series with continuous long-time and full-power output. And comprehensive electronic protections keep the entire system safer and more stable; IC series is applicable to various off-grid systems that need to convert DC into AC, such as RV power supply system, on-board system, monitoring system, emergency lighting system, household power supply system, small-scale on-site power supply and occasions with high requirements for power quality.

1.2 Product features

- ◆ Full digital voltage-current double closed-loop control, in high response speed and reliability.
- ◆ Advanced SPWM technology for pure sine wave.
- ◆ Advanced wave-filter and current-limiting technology, with impact load such as large capacitive and inductive available.
- ◆ Various output sockets to satisfy customers in different countries and regions.
- ◆ High power density and long-life devices for product reliability.
- ◆ Output power factor up to 1, with full load power for long-term operation.
- ◆ Low no-load loss and standby loss, low total harmonic distortion (THD), and high conversion efficiency.
- ◆ Input under-voltage/overvoltage protection, input overload/short-circuit protection, device over-temperature protection, fan fault protection, etc.
- ◆ Intelligent air cooling control system for detecting the output of fan blocked control.
- ◆ Output voltage: 220/230/240 VAC, output frequency: 50/60 Hz (settable).
- ◆ AC output overload protector for safe and reliable operation.
- ◆ Excellent Electromagnetic Compatibility (EMC) for locations with high power quality requirements.
- ◆ Rs485 communication interface for various components.
- ◆ Dual USB interface output with maximum support of 5V2A.
- ◆ Electron Coupled Oscillator (ECO) for maximum electric power saving.
- ◆ Transistor-Transistor Logic (TTL) communication interface for external Bluetooth or display screen connection and interaction.
- ◆ External switch contact for remote control of the inverter via external mechanical switches or relays.
- ◆ Supported Bluetooth and available mobile APP to check the operation condition/real-time data and fault condition.
- ◆ Optional Controller Area Network (CAN) communication of RV-C.

1.3 Appearance and interface description

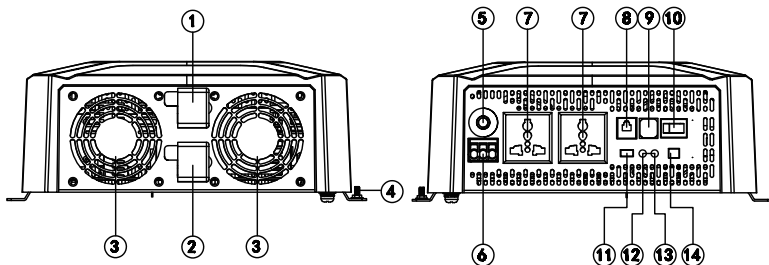

S/N	Name	S/N	Name
①	Positive electrode of battery input	⑧	RS485 communication interface
②	Negative electrode of Battery input	⑨	USB interface
③	Cooling fan	⑩	ON/OFF/ECO mode switch
④	Input grounding terminal	⑪	TTL communication interface
⑤	Output overload protector	⑫	Running indicator
⑥	AC output terminal 1	⑬	Fault indicator
⑦	AC output terminal 2	⑭	External switch contact interface

1.4 Dimension drawing

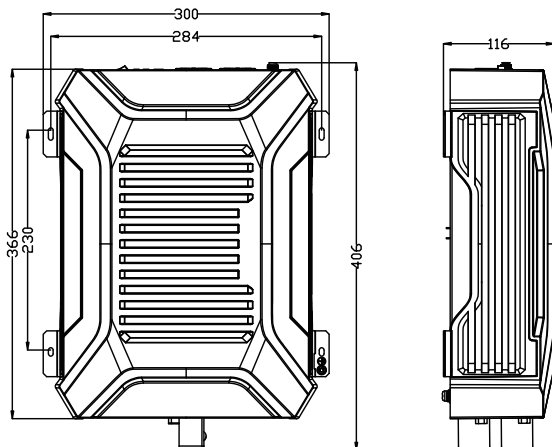

2. Specification

Product model	IC12-2KW	IC24-3KW	Remarks
Rated output power W	2000W	3000W	
Rated output power VA	2000VA	3000VA	
Withstand instantaneous impact power	4000W	6000W	
Rated output voltage	220VAC/230VAC/240VAC(±3%)		Default: 230 V, adjusted by communication
Output frequency	50/60HZ(±0.2%)		Default: 50 HZ, adjusted by communication
Output wave	Pure sine wave		
Output harmonic component	THDV < 4% (pure resistance load)		
Load power factor	0.2-1 (load power ≤ output continuous power)		
Rated input voltage	12VDC	24VDC	
Input voltage range	10.8~16.0VDC	21.6~32.0VDC	
Rated output efficiency	>89.0%	>90.0%	
Maximum output efficiency	> 92.0% (30% overload)	> 93.5% (30% overload)	
Standby current	<0.2A	<0.12A	OFF
No-load current	<1.0A	<0.95A	ON, No load
RS485 communication	Non-isolated RS485 communication, power supply 5VDC/200mA, remote switch of interface integration and CAN communication function (optional)		
USB interface	Dual USB output, 5VDC/2A		
ON/OFF/ECO mode	ON - AC normal output OFF - no AC output, standby ECO - energy-saving mode, auto switch		
ECO starting power	< 30W		30-100W (adjustable)
ECO interval time	1min		30s-30min (adjustable)
TTL interface	Non-isolated TTL communication, power supply 12.5V/200mA		
Indicator	Green - normal operation; Red - fault		
External switch contact interface	Switch on or off by control equipment such as external relay and mechanical switch		Adjust the 3rd position rocker switch to ON when using this function
Protection function	Input over-voltage/over-discharge protection, output overload/short-circuit protection, and device over-temperature protection		No input reverse connection protection!
Operating ambient temperature	-20°C~60°C		
Storage ambient temperature	-35°C~80°C		
Relative humidity	≤95%		
Protection grade	IP20		
Heat-dissipating method	Natural heat dissipation + intelligent air cooling		
Noise	≤60dB		
Product dimension	409*249*120mm		
Installation dimension	374*141*φ5mm		
Net weight	6.0kg		

3. Description of interface function

3.1 RS485 communication

- (1) Default baud rate: 9,600 bps, check bit: none, data bit: 8 bit, stop bit: 1 bit
- (2) Interface type: RJ45, communication power supply output specification: 5VDC/200mA
- (3) The RS485 communication line sequence is defined as follows, with interface integrating remote switch interface (SW1/SW2) and CAN communication interface. When the switch interface (SW1/SW2) is floating and open circuit = OFF mode; when the switch interface (SW1/SW2) is short-circuited = ON mode.

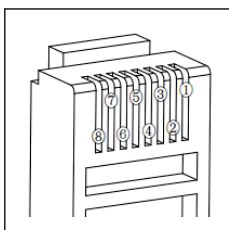

S/N	Definition
①	Positive terminal 5.0 VDC
②	D+
③	D-
④	Power ground
⑤	SW1
⑥	SW2
⑦	CANH
⑧	CANL

3.2 USB interface

Dual USB output interface with a total output capacity of 5V 2A is capable of charging mobile phone/PAD and other mobile devices, and no output when the battery is over-discharged or with over-voltage.

S/N	Definition
①	USB+5.0VDC
②	NC
③	NC
④	USB-

3.3 TTL communication interface

- (1) Default baud rate: 9,600 kps; parity bit: none; data bit: 8 bit; stop bit: 1 bit
- (2) Communication power output specification: 12.5 V/200 mA

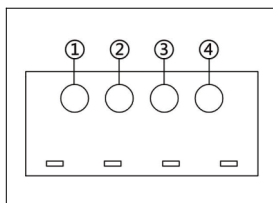

S/N	Description
①	VCC communication power supply output
②	RX - inverter data receiving end
③	TX - inverter data sending end
④	GND - power ground

3.4 Operating mode switch

With a 3rd position boat switch, the inverter has 3 operating modes including OFF, ON, and ECO when the external switch contact is closed.

Switch position	Definition of mode	Description of mode
OFF	Idle mode, no AC output	Device is in standby idle state, indicator, communication function, USB output and other functions are normal, no AC output
ON	Normal mode with AC output	Device is in normal working state with AC output
ECO	Energy-saving mode with Intermittent AC output	Device with the detected output load power lower than the ECO starting power (default 30W) will automatically close the AC output, enter idle mode, and re-start the AC output after ECO interval time (default 1min). And the AC will continuously output if the load power is larger than the ECO starting power (+10 W);
Remark: When using an APP or other communication devices to switch the working mode, the current actual working mode will be inconsistent with the boat switch position. The working mode of the inverter is based on the last adjusted position at the APP or communication device or the boat switch.		

3.5 LED indicator/buzzer

(1) Running indicator - green; fault indicator - red

(2) Indicator/buzzer are defined as follows:

Working state	Running indicator (Run) - green	Fault indicator (Fault) - red	Buzzer
Idle mode	Single flash	OFF	No buzz
Normal mode	Normal ON	OFF	No buzz
ECO mode	Slow flash	OFF	No buzz
Battery over-discharge	OFF	Slow flash	1 HZ buzz
Battery over-voltage	OFF	Fast flash	1 HZ buzz
Over-temperature protection of device	OFF	Double flash	1 HZ buzz
Overload operation	Normal ON	Single flash	1 HZ buzz
Overload protection	OFF	Single flash	1 HZ buzz
Load short-circuit protection	OFF	Normal ON	1 HZ buzz
Other faults (bus over-current/ inverter over-current/abnormal output voltage)	OFF	Normal ON	1 HZ buzz
Fan fault - output	Slow flash	Slow flash	No buzz
Fan fault - no output	OFF	Single flash	1 HZ buzz
Definition of indicator flashing:			
Slow flash	1s ON, 1s OFF in 2s		
Single flash	0.1s ON, 1.9s OFF in 2s		
Double flash	0.1s ON, 0.1s OFF, 0.1s ON and 1.7s OFF in period 2s		
Fast flash	1s ON, 0.1s OFF in 0.2s		

3.6 External switch contact interface

2P switch interface: Inverter can work when the interface is short-circuited; Inverter fails to work when the interface is open. The interface can be connected to a mechanical switch or relay to control the inverter to start/stop (this application requires keeping the mode switch in the ON or ECO mode position) in practical application.

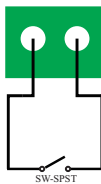

Application drawing 1: external mechanical switch

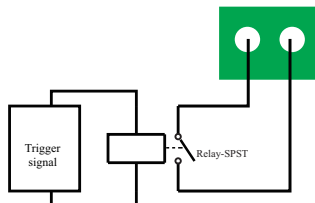

Application drawing 2: external relay switch

3.7 Bluetooth communication

Built-in Bluetooth communication function can monitor the operation data, fault status and adjust the operation parameters of the inverter in real time through mobile APP.

3.8 CAN communication (optional)

Optional built-in CAN communication and RV-C protocol are available to monitor the inverter's operation data and fault status, and adjust the inverter's operation parameters in real-time via the PV. See 3.1 for pin definition of CAN communication interface.

4. Installation instructions

4.1 Installation precautions

Please read this manual carefully before installation to be familiar with the installation steps.

- ◆ Be careful when installing battery. Wear safety goggles when installing a lead-acid liquid battery. Once coming into contact with the battery acid, rinse with clean water timely.
- ◆ Keep away from metal objects to prevent short-circuit of battery.
- ◆ The battery may produce acid gas when charging. Make sure that the ambient environment is well-ventilated.
- ◆ When installing the cabinet, there must be enough space around the inverter for heat dissipation; Do not install the inverter and lead-acid battery in the same cabinet to avoid corrosion by acid gas generated during battery operation.
- ◆ As false connections and corroded cables may cause extreme heat to melt the cable insulation, burn surrounding materials and even cause a fire, it is necessary to ensure that the connections are tightened, and the cables are fixed with ties to avoid loose connections due to shaking of cable on the move.
- ◆ The system connection cables selected shall have a current density $\leq 5A/mm^2$.
- ◆ During outdoor installation, direct sunlight and rainwater infiltration shall be avoided.
- ◆ After the power switch is turned off, there is still high voltage inside the inverter. Do not turn on or touch the internal devices. Carry out relevant operations after the capacitor is discharged.
- ◆ Do not install the inverter in harsh environments such as moist, oily, flammable or explosive, or heavily dusty areas.
- ◆ Polarity at the battery input terminal of this product shall not be reversed. Otherwise, it may damage the device or cause unpredictable danger.
- ◆ The AC output is a high voltage, so please do not touch the wiring.
- ◆ Do not touch the working fan to prevent injury.
- ◆ It is necessary to confirm that the inverter is the only input device for load, and it is forbidden to use it in parallel with other input AC power to avoid damage.

4.2 Wiring specifications and circuit breaker selection

Wiring and installation must comply with national and local electrical codes.

- ◆ Battery input wiring specifications and circuit breaker selection

Model	Rated input current	Battery input wiring specifications	Circuit breaker selection
IC12-2KW	196A	40mm ² /(3AWG*2)	DC-2P-250A
IC24-3KW	145A	30mm ² /2AWG	DC-2P-160A

- ◆ AC output wiring specifications and circuit breaker selection

Model	Rated output current	AC output wiring specifications	Circuit breaker selection
IC12-2KW	9.1A	2,5mm ² /13AWG	AC-2P-16A
IC24-3KW	13.6A	4mm ² /11AWG	AC-2P-25A



- ◆ The above are reference specifications. Please select the appropriate specification and model according to actual situations.
- ◆ The wiring diameter is for reference only. If the distance between the inverter and the battery is relatively long, using a thicker wire can reduce the voltage drop to improve system performance.
- ◆ The above are only recommended wiring diameter and circuit breaker. Please select the appropriate wiring diameter and circuit breaker according to actual situations.

4.3 Installation and wiring

Installation steps:

Step 1: Please read the user manual carefully.

Step 2: Determine the installation position and the space for heat dissipation.

Determine the installation position (wall-mounted or horizontal installation method can be adopted): when installing the inverter, confirm that there is enough space of at least 200mm reserved between the air outlet and air inlet of the inverter to facilitate air circulation.

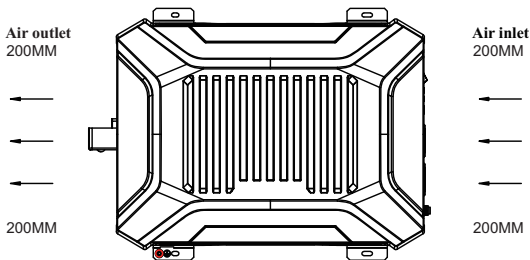

⚠ If the device is installed in a closed box, ensure that heat dissipation is allowed through the container. Otherwise, derate to use the device.

	<ul style="list-style-type: none">◆ The AC device shall be determined based on the inverter's continuous output power. The impact power of the AC device cannot be higher than the inverter's instantaneous impact power. Otherwise, the inverter may be damaged.
	<ul style="list-style-type: none">◆ Before wiring, switch the inverter to the OFF.◆ Do not close the circuit breaker or fuse during wiring, and check if the electrode leads of each component are properly connected.◆ The battery terminal shall be equipped with a fuse selected according to 2-2.5 times of the rated input current of the inverter, and the fuse must be at least 150 mm away from the battery terminal.◆ There is no reverse connection protection for the input, check if the Positive and Negative are connected correctly before connecting.

Wiring sequence:

3.1 Ground wire

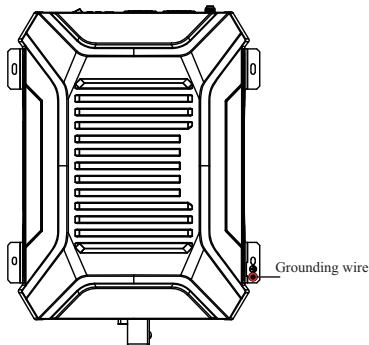

3.2 Positive/Negative wires of storage battery

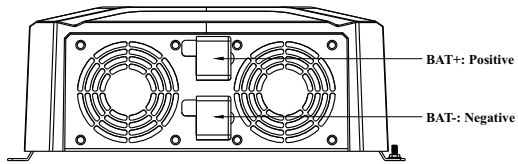

! There is no reverse connection protection for the input, check if the Positive and Negative are connected correctly before connecting, or the inverter may be damaged!

3.3 AC device

1) The device has two AC output interfaces. Connect the load device to the following 3P terminals if the power of a single load device is higher than 70% of the rated power, defined as follows:

⊕ N L

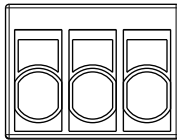

- ◆ Single strand copper wire with a wire diameter less than 4 mm² is recommended;
- ◆ Add soldering tin to the wiring place to make it integral and insert it into the corresponding hole if multiple strands of wire are used;
- ◆ Please connect the ground wire first, then the fire wire L and zero wire N.

⊕ N L

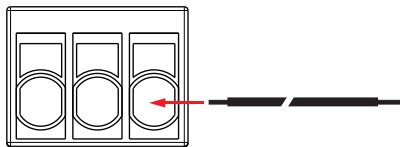

- ◆ Stop the inverter to remove the wiring, then use a sharp tool to insert the small hole above the interface and pull out the connecting wire by force.

⊕ N L

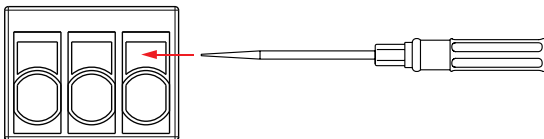

2) The inverter is equipped with the following two AC terminals, the maximum current bearing capacity of which is 10A.

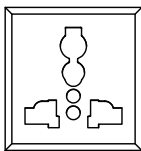

Step 4: Start the inverter

4.1 Close the circuit breaker at the inverter's DC input terminal or the fuse at the battery;

4.2 Short circuit the inverter's external switch contact interface (short-circuited for factory);

4.3 Set the inverter's mode switch to ON to start the inverter output: The running indicator is always green, and AC power output is normal;

4.4 Close the circuit breakers on the AC load line, turn on the AC load one by one, and check the operating status of the inverter and the load;

4.5 If the fault indicator is red with a buzzer alarm after starting the inverter, please turn off the load and inverter and refer to Common Problems and Solutions for troubleshooting. Repeat the preceding steps after the fault is rectified.

5. Protection function

5.1 Input of over-voltage protection

When the battery voltage is higher than the input voltage of over-voltage protection, turn off the AC output, and the fault indicator lamp and buzzer will prompt; When the battery voltage is lower than the input voltage (1V) of over-voltage protection, the AC output is recovered.

	12V system	24V system
Input voltage of over-voltage protection	16.0V	32.0V
Input recovery voltage of over-voltage protection	15.0V	31.0V

! Although the inverter has an input of overvoltage protection, the input voltage of the 12 V system shall not be higher than 20 V; The 24 V system input voltage shall not be higher than 35 V, otherwise, the inverter may be damaged.

5.2 Input of low-voltage protection

When the battery voltage is lower than the input voltage of low-voltage protection, turn off the AC output, and the fault indicator lamp and buzzer will prompt; When the battery voltage is higher than the input recovery voltage of low-voltage protection, the AC output is recovered.

	12V system	24V system
Input voltage of over-voltage protection	10.8V	21.6V
Input recovery voltage of low-voltage protection	12.0V	24.0V

5.3 Output of overload protection

Make corresponding protection according to different overload levels when the AC load is greater than the rated output power, as follows:

Load power	Possible duration
$102\% \leq P_o \leq 120\%$	1min
$120\% < P_o \leq 150\%$	30s
$P_o > 150\%$	10s

! The AC output has three automatic recoveries for inverter's overload protection (the first time delay is 5S, the second time delay is 10s, and the third time delay is 15s). The AC output will not automatically recover at the fourth time until restarting the inverter after checking the device and removing the faults.

5.4 Output of short-circuit protection

When the AC output L/N is short-circuited, the inverter automatically turns off the AC output, and fault indicator and buzzer prompt.



The AC output has three automatic recoveries for inverter's short-circuit protection (the first time delay is 5S, the second time delay is 10s, and the third time delay is 15s). The AC output will not automatically recover at the fourth time until restarting the inverter after removing the faults.

5.5 Over-temperature protection of device

With multiple internal temperature detections, the device under any temperature higher than the device over-temperature protection will automatically turn off the AC output, and fault indicator and buzzer will prompt; The AC output will be recovered if the temperature is lower than the over-temperature protection.



Please keep a good ventilation environment to ensure that the inverter can operate reliably and stably at full power for a long time.

5.6 Fault protection of fan

If the fan is blocked or not operate for other reasons, the AC output of the inverter can only work within 30% of the rated output power and will be turned off when the load power is higher than 30% of the rated power.



To ensure that the inverter can run reliably and stably at full power for a long time, please keep a good installation environment to avoid fan blocking by oil and wire. And check the fan operation regularly.

6. Common problems and solutions

S/N	Phenomenon	Cause	Possible cause	Solutions
1	Red light flashing slowly, green light off, buzzer buzzing, no AC output	Over-low battery input voltage	1. Excessive voltage drop due to over-small battery wiring diameter 2. Low battery power.	1. Choose the suitable wires; 2. Timely charge the battery until the low voltage recovery voltage can self-restore the output.
2	Red light flashing quickly, green light off, buzzer buzzing, no AC output	Over-high battery input voltage	1. Mismatch between battery voltage and device system voltage	Measure the positive and negative terminal voltage of the device with a voltmeter to determine whether they are higher than the over-voltage protection voltage, and recover by adjusting the input voltage
3	Red light single flashing, green light always on, buzzer buzzing, with AC output	Overload	Power of load device higher than rated output power	Check whether the AC load is within the rated power range of the inverter;
4	Red light single flashing, green light off, buzzer buzzing, no AC output	Overload	Power of load device higher than rated output power	Check whether the AC load is within the rated power range of the inverter; Eliminate the load overload fault and restart the inverter to restore normal operation.
5	Red light always on, green light off, buzzer buzzing, no AC output	Load short-circuited	1. AC output of the inverter short-circuited 2. AC device L/N short-circuited	Check whether the AC load wiring is short-circuited; Eliminate the load short-circuit fault and restart the inverter to restore normal operation.
6	Red light double flashing, green light off, buzzer buzzing, no AC output	Over-high device temperature	Internal temperature of device higher than the set over-temperature protection	Improve the quality of ventilation, clear the vent, reduce the temperature around the inverter, and restart the device after the temperature is reduced. Please declare the amount if troubleshooting fails.
7	Red light and green light single flashing, buzzer buzzing, with AC output or unable to reach the rated power output	Fan fault	Fan blocked by any object	Check whether the fan works properly.

7. System maintenance

In order to maintain the best long-term performance, it is recommended to conduct following checks twice a year.

- ◆ Make sure that the airflow around the inverter is smooth and remove any dirt or debris from the heat sink.
- ◆ Check whether all exposed wires are damaged by exposure to sunlight, friction with other objects around them, dryness, bite by insects or rodents, etc. The wires shall be repaired or replaced if necessary.
- ◆ Verify for the consistency of indicator and display with the operation of the device. Please pay attention to any faults or errors, and take corrective actions if necessary.
- ◆ Check all wiring terminals for corrosion, insulation damage, signs of high temperature or burning/ discoloration, and tighten the screws.
- ◆ Check for dirt, nesting insects and corrosion, and clean up as required.
- ◆ The arrester failed shall be replaced in time against lightning damage to the inverter or even other device of the user.

⚠ Danger of electric shock! Make sure that the inverter power is disconnected and the power in the capacitor is discharged before carrying out the corresponding checks or operations!

The Company does not assume any liability for damage caused by:

- ◆ Improper use or use in improper site.
- ◆ Current, voltage and power of the load exceeding the limit of the inverter.
- ◆ Temperature in the operating environment exceeding the limited operating temperature range.
- ◆ Arcing, fire and explosion caused by failure to follow inverter markings or manual instructions.
- ◆ Disassemble and repair the inverter without permission.
- ◆ Force majeure.
- ◆ Damage that occurs in transportation or handling of the inverter

COMMUNICA
A World Of Electronics



www.communica.co.za

Pretoria

65 Francis Baard Street
Pretoria, 0002, South Africa

☎ +27 (0)12 328 7008

☎ +27 (0)12 328 7018

✉ salespt@communicaco.za

Head Office

53 Landmarks Avenue
Samrand, 0157
Centurion, South Africa

☎ +27 (0)12 657 3500

☎ +27 (0)12 657 3550

✉ sales@communicaco.za

Cape Town

36 Marine Drive
Paarden Eiland, 7405
Cape Town, South Africa

☎ +27 (0)21 447 0949

☎ +27 (0)21 447 0959

✉ salesct@communicaco.za