



PASSIVE INFRARED SENSOR

PA-6812E/(BL) (Wide angle) PA-6810E/(BL) (360° Round)  LISTED
 PA-6820E/(BL) (Vertical curtain) PA-6805E/(BL) (Spot)  



COMPACT APPEARANCE, OUTSTANDING PERFORMANCE WITH COMPETITIVE PRICE

COMPACT DESIGN

Our high technology provides the world's smallest dome shaped infrared sensor.

Super slim & compact design-120mm in diameter and 47mm in height.30% smaller than PA-6700 series.

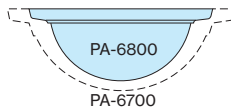

EASY INSTALLATION

Easy separation of the sensor unit and the base unit eases installation and maintenance.

The sensor unit can be snapped into and out of the base unit. One touch operation eases installation in high places.

MIRROR OPTIC (PA-6812E / PA-6820E)

The CAD designed optic with our original simulation software has achieved sharp zones.

A rotating mirror ensures efficient detection regardless of the area setting.

SILENT RELAY

Photo-mos FET switch relay adopted at alarm output. Completely noiseless by eliminating the movable part which is inside of the relay.

HIGH STABILITY

Signal processing by the original CPU. Excellent R.F.I and noise immunity. Good protection against insect intrusion.

SENSITIVITY CHANGEOVER

Sensitivity is adjustable by 4 steps : 60%, 80%, 100%, 120%.

PULSE COUNT CHANGEOVER

Mode selector allows setting for 1, 2, 3 or 4 triggers to initiate an alarm output to suit its application. (PA-6812E / PA-6810E / PA-6805E)

ALARM CONTACT CHANGEOVER

Mode selector allows N.C. or N.O. contact to be selected.

REMOTE LED CONTROL

Alarm LED can be disabled by external contact switch.

AUTO ALARM MEMORY

Alarm memory can be auto-reset or disabled by mode selector.

OTHER FEATURES

Distinguishable operation LED - -
 Alarm LED : Red, Memory LED : Yellow
 Wall / Ceiling mounted with optional attachment BCW-401.

PASSIVE INFRARED SENSOR

COVERAGE

PA-6812E (Wide angle)

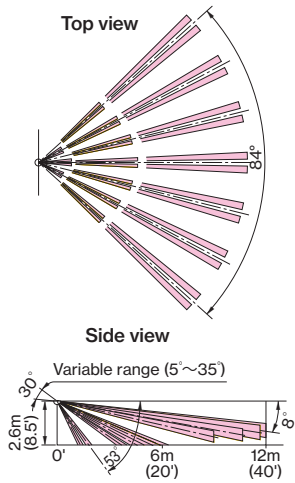

PA-6810E (360° Round)

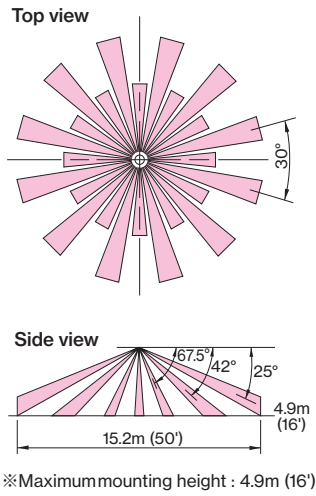

PA-6820E (Vertical curtain)

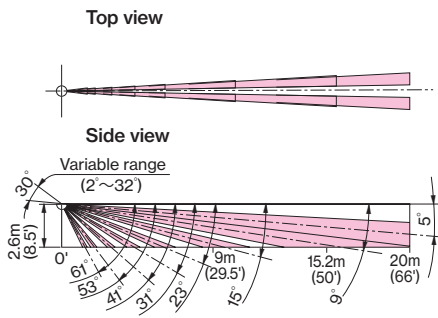

PA-6805E (Spot)

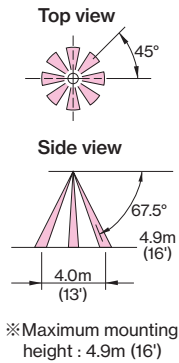

TERMINAL ARRANGEMENT

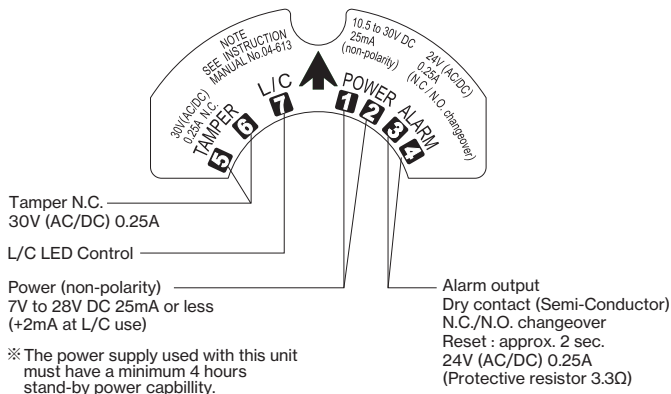

EXTERNAL DIMENSIONS

[Unit : mm (inch)]

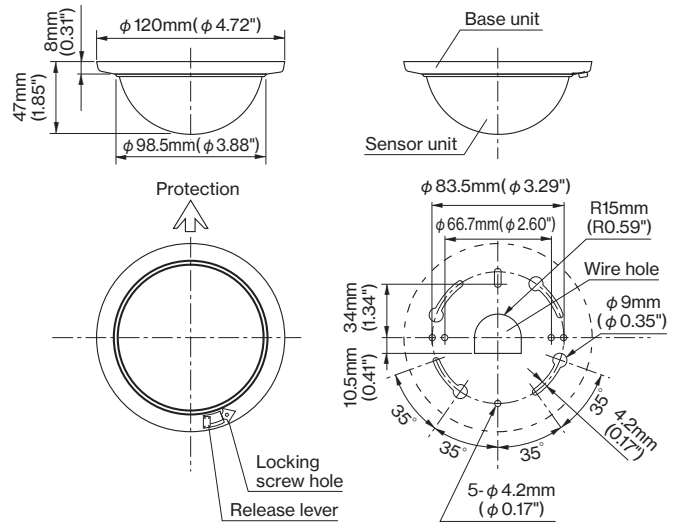

SPECIFICATIONS

Product name	PASSIVE INFRARED SENSOR			
Model	PA-6812E	PA-6810E	PA-6805E	PA-6820E
Detection system	Passive infrared			
Coverage	Wide angle 12m(40') Max.	360°Round φ15.2m (φ 50') Max.	Spot φ 4m (φ 13') Max.	Vertical curtain 20m(66') Max.
Sensitive zone	17 pairs	33 pairs	9 pairs	8 pairs
Supply voltage	7 to 28V DC (non-polarity)			
Current consumption	11mA Max. (+2mA at L/C use)			
Alarm signal	Dry contact (Semi-Conductor) (N.C./N.O. changeover) Reset : Approx. 2 sec., 24V (AC/DC) 0.25A (protective resistor 3.3Ω)			
Alarm memory	3 minutes flashing, 47 minutes lighting and automatically reset			
Alarm LED	Red : Flashing at warming up Lighting at alarm (LED disabled)			
Memory LED	Yellow : Flashing at memory activated Lighting at memory indication			
Adjustment	Vertically : 30°		Vertically : 30°	
	Horizontally : 25° (on mounting hole of base)			
Count changeover	1 / 2 / 3 / 4 changeover			
Ambient temperature range	-15°C to +55°C (+5°F to +131°F) without condensation			
Mounting position	Indoor ceiling (wall mount with optional attachment BCW-401)			
Wiring connection	Terminals on separate base unit			
Weight	110g (3.85oz)			
Appearance	Body ,Cover : Resin			
Accessory	Tapping screw : 2 pcs. Sensor locking screw : 1 pce.			

* The specifications are subject to change without notice.

OPTIONAL

●Wall / Ceiling mount attachment BCW-401



●Wall / Ceiling mount attachment BL-5000



Please note : This sensor is designed to detect intrusion and to initiate an alarm; it is not a burglary or a crime preventing device. TAKEX is not responsible for damage, injury or losses caused by accident, theft, Acts of God (including inductive surge by lightning), abuse, misuse, abnormal usage, faulty installation or improper maintenance.

TAKEX

In Japan

Takenaka Engineering Co., Ltd.
83-1, Gojo-Dori, Sotokan Nishi-iru, Higashino,
Yamashina-ku, Kyoto 607-8156, Japan
Tel : 81-75-501-6651

<https://www.takex-eng.co.jp/>

In the U.S.

Takex America Inc.
1810 Oakland Rd, Suite F,
San Jose, CA 95131, USA
TEL : 408-747-0100
FAX : 408-734-1100

<https://www.takex.com>

In Australia

Takex America Inc.
4/15 Howleys Road, NottingHill,
VIC,3168
Tel : +61 (03) 9544-2477
Fax : +61 (03) 9543-2342

<https://www.takex.com>

In the U.K.

Takex Europe Ltd.
Aviary Court, Wade Road,
Basingstoke, Hampshire. RG24 8PE, U.K.
Tel : (+44) 01256-475555
Fax : (+44) 01256-466268

<https://www.takex.com>