

MORNSUN®

URB_LD-20W SERIES

20W, ULTRA WIDE INPUT, ISOLATED & REGULATED SINGLE OUTPUT DC-DC CONVERTER



RoHS

FEATURES

- 4:1 Ultra Wide Input Voltage Range
- 1.5kVDC Input/Output Isolation
- Short Circuit Protection (Automatic Recovery)
- Operating Temperature: -40°C ~ +85°C
- Internal SMD Construction
- Metal Shielding Package
- Industry Standard Pinout
- MTBF>1,000,000 hours
- RoHS Compliance

APPLICATION

The URB_LD-20W series offer 20W of output, with 4:1 ultra wide input voltage of 9-36VDC, 18-75VDC, and features 1500VDC isolation, over current, over voltage and short-circuit protection, as well as six sided metal shielding. All models are particularly suited to industrial, tele-communications, test equipments power.

MODEL SELECTION

URB2405LD-20W

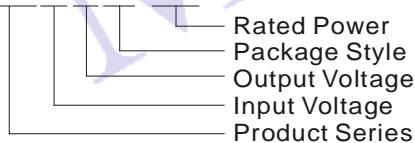

PRODUCT PROGRAM

Model	Input			Output		Efficiency (Typ. %)	Capacitor Load Max ⁽³⁾ (µF)
	Voltage (VDC)			Voltage (VDC)	Rated Current ⁽²⁾ (mA)		
	Nominal	Range	Max ⁽¹⁾				
URB2403LD-20W	24	9-36	40	3.3	5000	83	18700
URB2405LD-20W				5	4000	86	9600
URB2412LD-20W				12	1667	87	1600
URB2415LD-20W				15	1333	88	1000
URB2424LD-20W				24	834	88	500
URB4803LD-20W	48	18-75	80	3.3	5000	83	18700
URB4805LD-20W				5	4000	87	9600
URB4812LD-20W				12	1667	88	1600
URB4815LD-20W				15	1333	88	1000
URB4824LD-20W				24	834	88	500

Add suffix "H" for heatsink mounted, for example URB2405LD-20WH.

COMMON SPECIFICATIONS

Item	Test conditions	Min.	Typ.	Max.	Units
Storage humidity		5	--	95	%
Operating temperature		-40	--	85	°C
Storage temperature		-55	--	125	
Maximum Case Temp.	On working temperature	--	--	105	
Lead temperature	1.5mm from case for 10 seconds	--	--	300	
Isolation voltage	Test for 1 minute and 1 mA max	1500	--	--	VDC
Isolation resistance	Test at 500VDC	1000	--	--	MΩ
Isolation capacitance	100kHz/0.1V	--	1000	--	pF
Switching frequency	Nominal input, 100% load	--	400	--	kHz
MTBF	MIL-HDBK-217F	1000	--	--	k hours
Weight		--	28	--	g
Cooling		Free Air Convection			
Case material		Aluminum Alloy			

INPUT SPECIFICATIONS

Item	Test conditions	Min.	Typ.	Max.	Units	
Under voltage lockout	Nominal input (24V)	Models ON	--	--	9.0	VDC
		Models OFF	8.0	--	--	
	Nominal input (48V)	Models ON	--	--	17.8	
		Models OFF	16.0	--	--	
Input filter		PI				
Start-up time		--	10	--	ms	
Ctrl ⁽⁴⁾	Models ON	3.5 -12VDC or open circuit				
	Models OFF	0-1.2VDC				
	Input current (models OFF)	--	--	1	mA	

MORNSUN Science & Technology Co.,Ltd.

Address: No. 5, Kehui St. 1, Kehui development center, Science Ave., Guangzhou Science City, Luogang district, Guangzhou, P.R.China.

Tel: 86-20-38601850

Fax: 86-20-38601272

E-mail: info@mornsun.cn

[Http://www.mornsun-power.com](http://www.mornsun-power.com)

OUTPUT SPECIFICATIONS

Item	Test conditions	Min.	Typ.	Max.	Units
Output power	See product program	2	--	20	W
Output voltage accuracy	Refer to recommended circuit	--	±1	±3	%
Load regulation	From 10% to 100% load	--	±0.5	±1	
Line regulation	Input voltage from low to high 100% load	--	±0.2	±0.5	
Ripple and noise	20MHz bandwidth	55	75	150	mV
Transient recovery time	25% load step change	--	200	500	us
Transient peak deviation		--	±3	±5	%
Over current protection	Input voltage range	120	130	150	%
Short circuit protection	Input voltage range	Hiccup, automatic recovery			
Over voltage protection	3.3V output	--	3.9	--	VDC
	5V output	--	6.2	--	
	12V output	--	15	--	
	15V output	--	18	--	
Temperature drift (Vout)	Refer to recommended circuit	--	±0.02	--	%/°C
Trim		--	±10%V	--	VDC

TRIM APPLICATION & TRIM RESISTANCE

Application circuit for TRIM (Part in broken line is the interior of models)

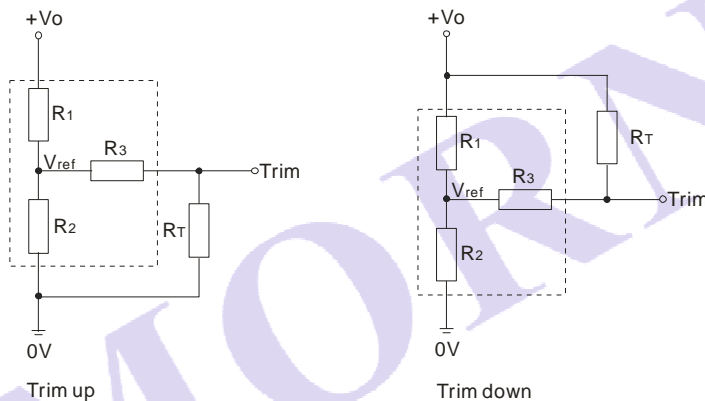

Formula for resistance of Trim

$$\begin{aligned} \text{up: } R_T &= \frac{aR_2}{R_2-a} - R_3 & a &= \frac{V_{ref}}{V_o' - V_{ref}} \cdot R_1 \\ \text{down: } R_T &= \frac{aR_1}{R_1-a} - R_3 & a &= \frac{V_o' - V_{ref}}{V_{ref}} \cdot R_2 \end{aligned}$$

Note: Value for R1, R2, R3, and Vref refer to the following table.

R_T: Resistance of Trim

a: User-defined parameter, no actual meanings.

V_{o'}: The trim up/down voltage

Vo Resistance	3.3 (VDC)	5 (VDC)	12 (VDC)	15 (VDC)	24 (VDC)
R1(KΩ)	4.80	2.88	10.97	14.50	24.87
R2(KΩ)	2.86	2.86	2.86	2.86	2.86
R3(KΩ)	15	10	17.8	17.8	20
Vref(V)	1.24	2.5	2.5	2.5	2.5

RECOMMENDED CIRCUIT

1) Recommended circuit

All the URB_LD-20W series have been tested according to the following recommended testing circuit before leaving factory. This series should be tested under load. Never be tested under no load (see Figure 1).

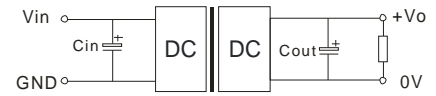

(Figure 1)

If you want to further decrease the output ripple, you can increase capacitance properly or choose capacitors with low ESR. However, the capacitance can't exceed the maximum capacitor load in the list.

2) Recommended capacitance

Capacitance Output voltage	Cout(μF)	Cin(μF) (24V,48V Input)
3.3(VDC)	470	100
5(VDC)	470	
12(VDC)	220	
15(VDC)	220	
24(VDC)	100	

3) No parallel connection or plug and play DERATING & EFFICIENCY CURVE

1) Temperature derating curve

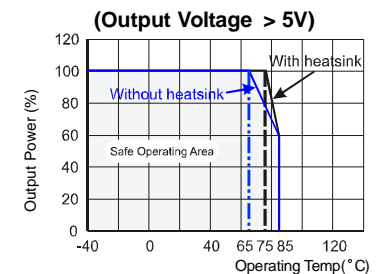
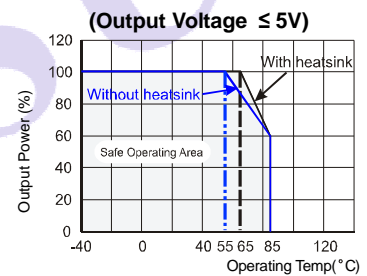

2) Efficiency VS Input Voltage

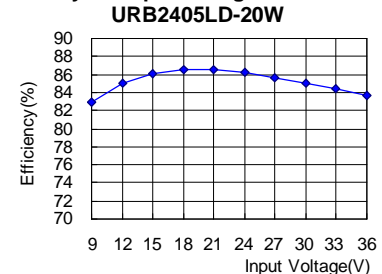

3) Efficiency VS Output Load

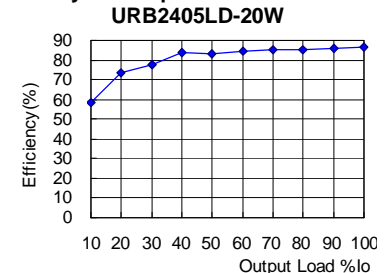

OUTLINE DIMENSIONS & FOOTPRINT DETAILS

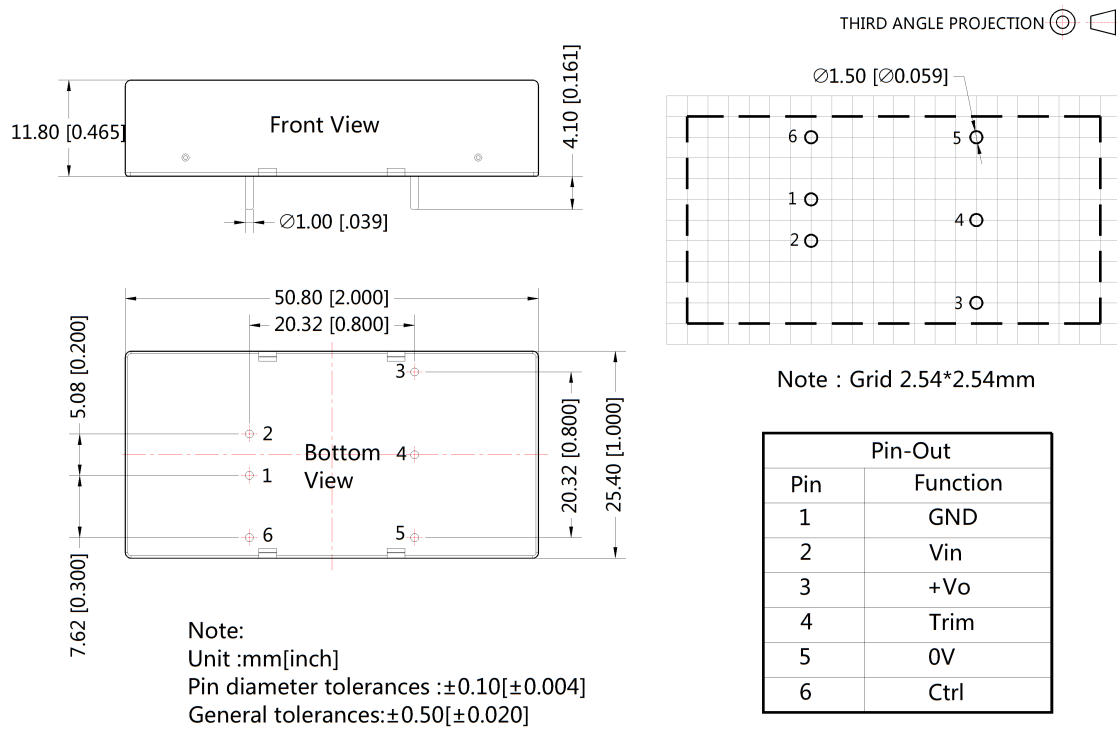

HEATSINK ASSEMBLY & PACKAGE DIAGRAM(WITH HEATSINK)

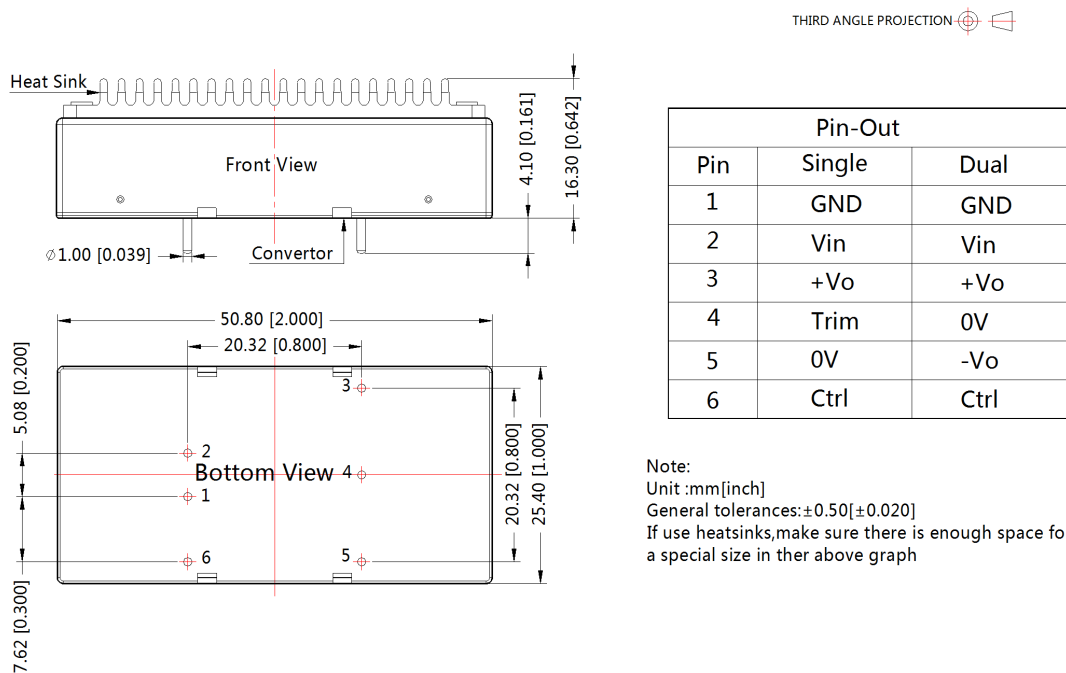

NOTES

1. Input voltage can't exceed this value, or will cause the permanent damage.
2. Minimum operating current is 10% of rated current, if less than 10% rated current, output ripple may increase rapidly, the amplitude $\leq 1V$.
3. Capacitor Max load tested at nominal input voltage and constant resistive load.
4. The CTRL control pin voltage is referenced to GND.
5. Only typical model listed. Non-standard models will be different from the above, please contact us for more details.
6. All specifications are measured at $TA=25^{\circ}C$, humidity $<75\%$, nominal input voltage and rated output load unless otherwise specified.
7. In this datasheet, all the test methods of indications are based on corporate standards.