

15W&20W, Ultra wide input isolated & regulated dual / single output DC/DC converter

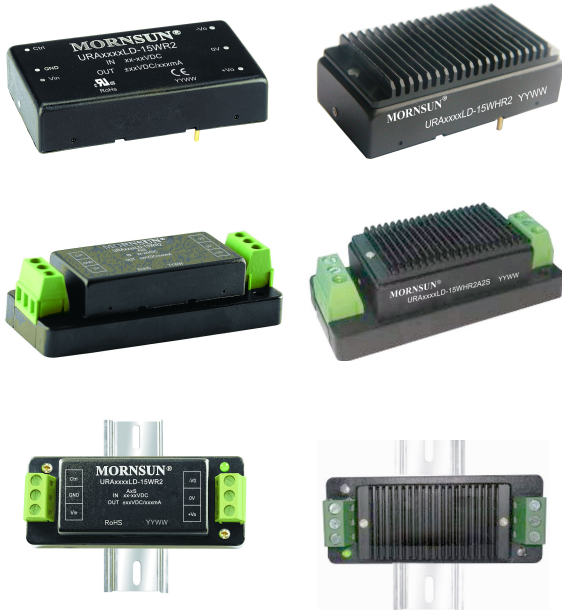

### FEATURES

- Wide range of input voltage (4:1)
- Efficiency up to 90%
- Isolation voltage : 1.5K VDC
- Output over-voltage, over-current, Short circuit protection
- Operating temperature range: -40°C to +85°C
- Six-sided metal shielding package
- Meet CISPR22/EN55022 CLASS A
- A2S (wring mounting) and A4S (35mm rail mounting) products featuring anti-reverse connection for input
- Meet UL60950 and EN60950
- International standard pin-out

Patent Protection RoHS

URA(B)\_LD-15WR2 & URA(B)\_LD-20WR2 series are applied to wide voltage range input situation such as data transmission device, battery power supply device, telecommunication device, distributed power supply system, remote control system, industrial robot system etc.

### Selection Guide

| Certification | Part No. ①      | Input Voltage (VDC) |        | Output               |                                | Efficiency ②<br>(%,Min./Typ.)<br>@ Full Load | Max. Capacitive Load ③ (μF) |
|---------------|-----------------|---------------------|--------|----------------------|--------------------------------|--|-----------------------------|
|               |                 | Nominal (Range)     | Max. ② | Output Voltage (VDC) | Output Current (mA)(Max./Min.) |  |                             |
| CE            | URA2405LD-15WR2 | 24<br>(9-36)        | 40     | ±5                   | ±1500/±75                      | 84/86  | 4800                        |
|               | URA2412LD-15WR2 |                     |        | ±12                  | ±625/±32                       | 86/88  | 800                         |
|               | URA2415LD-15WR2 |                     |        | ±15                  | ±500/±25                       | 86/88  | 500                         |
|               | URB2403LD-15WR2 |                     |        | 3.3                  | 4000/200                       | 85/87  | 10200                       |
|               | URB2405LD-15WR2 |                     |        | 5                    | 3000/150                       | 88/90  | 4020                        |
|               | URB2412LD-15WR2 |                     |        | 12                   | 1250/63                        | 87/89  | 1035                        |
|               | URB2415LD-15WR2 |                     |        | 15                   | 1000/50                        | 87/89  | 705                         |
|               | URB2424LD-15WR2 |                     |        | 24                   | 625/31                         | 88/90  | 470                         |
| UL/CB/CE      | URA4805LD-15WR2 | 48<br>(18-75)       | 80     | ±5                   | ±1500/±75                      | 84/86  | 4800                        |
|               | URA4812LD-15WR2 |                     |        | ±12                  | ±625/±32                       | 86/88  | 800                         |
|               | URA4815LD-15WR2 |                     |        | ±15                  | ±500/±25                       | 87/89  | 500                         |
|               | URB4803LD-15WR2 |                     |        | 3.3                  | 4000/200                       | 83/85  | 10200                       |
|               | URB4805LD-15WR2 |                     |        | 5                    | 3000/150                       | 85/87  | 4020                        |
| CE            | URA2405LD-20WR2 | 24<br>(9-36)        | 40     | ±5                   | ±2000/±100                     | 84/86  | 4800                        |
|               | URA2412LD-20WR2 |                     |        | ±12                  | ±834/±42                       | 86/88  | 800                         |
|               | URA2415LD-20WR2 |                     |        | ±15                  | ±667/±33                       | 86/88  | 625                         |
|               | URB2403LD-20WR2 |                     |        | 3.3                  | 5000/250                       | 84/86  | 18700                       |
|               | URB2405LD-20WR2 |                     |        | 5                    | 4000/200                       | 88/90  | 9600                        |

| Series | Model           | Input Voltage (V) | Output Voltage (V) | Output Power (W) | Efficiency (%) | Temperature (°C) |
|--------|-----------------|-------------------|--------------------|------------------|----------------|------------------|
| CE     | URB2409LD-20WR2 | 24<br>(9-36)      | 40                 | 9                | 2222/111       | 86/88            |
|        | URB2412LD-20WR2 |                   |                    | 12               | 1667/84        | 87/89            |
|        | URB2415LD-20WR2 |                   |                    | 15               | 1333/67        | 88/90            |
|        | URB2424LD-20WR2 | 48<br>(18-75)     | 80                 | 24               | 834/42         | 88/90            |
|        | URA4805LD-20WR2 |                   |                    | ±5               | ±2000/±100     | 84/86            |
|        | URA4812LD-20WR2 |                   |                    | ±12              | ±834/±42       | 86/88            |
|        | URA4815LD-20WR2 |                   |                    | ±15              | ±667/±33       | 87/89            |
| UL/CE  | URB4803LD-20WR2 | 48<br>(18-75)     | 80                 | 3.3              | 5000/250       | 84/86            |
|        | URB4805LD-20WR2 |                   |                    | 5                | 4000/200       | 86/88            |
|        | URB4812LD-20WR2 |                   |                    | 12               | 1667/84        | 87/89            |
|        | URB4815LD-20WR2 |                   |                    | 15               | 1333/67        | 88/90            |
|        | URB4824LD-20WR2 |                   |                    | 24               | 834/42         | 88/90            |

Note:

- Series with suffix "H" are heat sink mounting; series with suffix "A2S" are chassis mounting, with suffix "A4S" are DIN-Rail mounting, for example URB2405LD-15WR2A2S is chassis mounting of with heat sink. URB2405LD-15WR2A4S is DIN-Rail mounting of without heat sink; If the application has a higher requirement for heat dissipation, you can choose modules with heat sink;
- Absolute maximum rating without damage on the converter, but it isn't recommended;
- The efficiency of A2S (wiring type) and A4S (rail type) products is 2% lower than the above-mentioned value due to the reverse connection protection for input;
- The capacitive loads of positive and negative outputs are identical.

### Input Specifications

| Item                                | Operating Conditions                     |             | Min.  | Typ. | Max.   | Unit   |
|-------------------------------------|--|-------------|---|------|--------|--------|
| Input Current (full load / no-load) | 15W                                      | 24VDC input | 3.3/5 VDC output  | --   | 726/45 | 745/60 |
|                                     |  |             | Others output   | --   | 711/15 | 727/25 |
|                                     |  | 48VDC input | 3.3/5 VDC output  | --   | 363/35 | 372/50 |
|                                     |  |             | Others output   | --   | 355/10 | 363/20 |
|                                     | 20W                                      | 24VDC input | 3.3/5 VDC output  | --   | 969/60 | 992/75 |
|                                     |  |             | Others output   | --   | 947/15 | 970/25 |
|                                     |  | 48VDC input | 3.3/5 VDC output  | --   | 485/35 | 496/50 |
|                                     |  |             | Others output   | --   | 473/10 | 485/20 |
| Reflected Ripple Current            | 24VDC/48VDC input                        |             | --  | 30   | --     |        |
| Input impulse Voltage (1sec. max.)  | 24VDC input                              |             | -0.7  | --   | 50     | VDC    |
|                                     | 48VDC input                              |             | -0.7  | --   | 100    |        |
| Input Filter                        | Pi filter                                |             |   |      |        |        |
| Starting Time                       | Nominal input & constant resistance load |             | --  | 10   | --     | ms     |
| Ctrl*                               | Module switch on                         |             | Ctrl suspended or connected to TTL high level (2.5-12VDC) |      |        |        |
|                                     | Module switch off                        |             | Ctrl pin connected to GND or low level (0-1.2VDC)         |      |        |        |
|                                     | Input current when switched off          |             | --  | 1    | --     | mA     |
| Hot Plug                            | Unavailable                              |             |   |      |        |        |

Note: \* the voltage of Ctrl pin is relative to input pin GND.

### Output Specifications

| Item                         | Operating Conditions  | Min. | Typ. | Max. | Unit |
|------------------------------|---|------|------|------|------|
| Output Voltage Accuracy      | Positive output   | --   | ±1   | ±3   | %    |
|                              | Negative output   |      |      |      |      |
| Balance of Output Voltage    | Dual output, balanced load  | --   | ±0.5 | ±1   |      |
| Line Regulation              | Full load, the input voltage is from low voltage to high voltage              | --   | ±0.2 | ±0.5 |      |
| Load Regulation              | 5%-100% load  | --   | ±0.5 | ±1   |      |
| Cross Regulation             | Dual output, main circuit with 50% load, auxiliary circuit with 10%-100% load | --   | --   | ±5   | %    |
| Transient Recovery Time      | 25% load step change  | --   | 300  | 500  | μs   |
| Transient Response Deviation |   | --   | ±3   | ±5   | %    |

|                               |                     |                                   |        |     |        |
|-------------------------------|---------------------|-----------------------------------|--------|-----|--------|
| Temperature Drift Coefficient | Full load           | --                                | ±0.02  | --  | %/°C   |
| Ripple & Noise *              | 20MHz bandwidth     | --                                | 70     | 100 | mV p-p |
| Trim                          |                     | --                                | ±10%Vo | --  |        |
| Over-voltage Protection       | 3.3VDC output       | --                                | 3.9    | --  | VDC    |
|                               | 5VDC output         | --                                | 6.2    | --  |        |
|                               | 9VDC output         | --                                | 10.8   | --  |        |
|                               | 12VDC output        | --                                | 15     | --  |        |
|                               | 15VDC output        | --                                | 18     | --  |        |
|                               | 24VDC output        | --                                | 30     | --  |        |
| Over-current Protection       | Input voltage range | --                                | 160    | --  | %      |
| Short circuit Protection      |                     | Hiccup, Continuous, self-recovery |        |     |        |

Note: \*Ripple and noise are measured by "parallel cable" method, please see DC-DC Converter Application Notes for specific operation.

### General Specifications

| Item                               | Operating Conditions   | Min.                                   | Typ. | Max. | Unit    |    |
|------------------------------------|--|--|------|------|---------|----|
| Isolation Voltage                  | Input-output, with the test time of 1 minute and the leak current lower than 1mA | 1500                                   | --   | --   | VDC     |    |
| Isolation Resistance               | Input-output, isolation voltage 500VDC   | 1000                                   | --   | --   | MΩ      |    |
| Isolation Capacitance              | Input-output, 100KHz/0.1V  | 24VDC output                           | --   | 2000 | --      | pF |
|                                    |  | Others                                 | --   | 1000 | --      |    |
| Operating Temperature              | Derating if the temperature is ≥71°C (see Fig. 1)                                | -40                                    | --   | +85  | °C      |    |
| Storage Temperature                |  | -55                                    | --   | +125 |         |    |
| Storage Humidity                   | Non-condensing   | 5                                      | --   | 95   | %RH     |    |
| Pin Welding Resistance Temperature | Welding spot is 1.5mm away from the casing, 10 seconds                           | --                                     | --   | +300 | °C      |    |
| Vibration                          |  | 10-55Hz, 10G, 30 Min. along X, Y and Z |      |      |         |    |
| Switching Frequency                | PWM mode   | --                                     | 300  | --   | KHz     |    |
| MTBF                               | MIL-HDBK-217F@25°C   | 1000                                   | --   | --   | K hours |    |

### Physical Specifications

| Casing Material |                   | Aluminum alloy   |  |                            |  |
|-----------------|-------------------|--|--|----------------------------|--|
| Dimension       | Without heat sink | Horizontal package                                     |  | 50.80*25.40*11.80mm        |  |
|                 |                   | A2S wiring package                                     |  | 76.00*31.50*21.20 mm       |  |
|                 |                   | A4S rail package                                       |  | 76.00*31.50*25.80 mm       |  |
|                 | With heat sink    | Horizontal package                                     |  | 50.80*25.40*16.30mm        |  |
|                 |                   | A2S wiring package                                     |  | 76.00*31.50*25.10 mm       |  |
|                 |                   | A4S rail package                                       |  | 76.00*31.50*29.70 mm       |  |
| Weight          | Without heat sink | Horizontal package/A2S wiring package/A4S rail package |  | 28.00g/50.00g/70.00g(Typ.) |  |
|                 | With heat sink    | Horizontal package/A2S wiring package/A4S rail package |  | 36.00g/58.00g/78.00g(Typ.) |  |
| Cooling Method  |                   | Free air convection                                    |  |                            |  |

### EMC Specifications

|     |   |   |  |                  |                  |
|-----|---|---|--|------------------|------------------|
| EMI | CE  | CISPR22/EN55022 CLASS A (Bare component)/ CLASS B (see Fig.3-② for recommended circuit) |  |                  |                  |
|     | RE  | CISPR22/EN55022 CLASS A (Bare component)/ CLASS B (see Fig.3-② for recommended circuit) |  |                  |                  |
| EMS | ESD   | IEC/EN61000-4-2   | Contact ±4KV                               | perf. Criteria B |                  |
|     | RS  | IEC/EN61000-4-3   | 10V/m                                      | perf. Criteria A |                  |
|     | EFT   | IEC/EN61000-4-4   | ±2KV (see Fig.3-① for recommended circuit) | perf. Criteria B |                  |
|     | Surge   | IEC/EN61000-4-5   | ±2KV (see Fig.3-① for recommended circuit) | perf. Criteria B |                  |
|     | CS  | IEC/EN61000-4-6   | 3 Vr.m.s                                   | perf. Criteria A |                  |
|     | Voltage dips, short interruptions and voltage variations immunity |   | IEC/EN61000-4-29                           | 0-70%            | perf. Criteria B |

Product Characteristic Curve

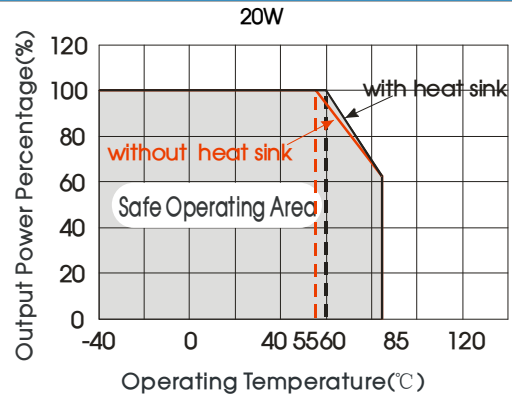
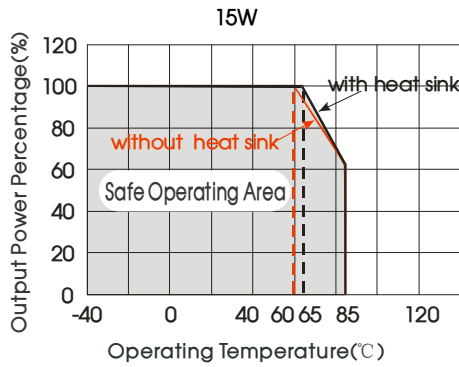
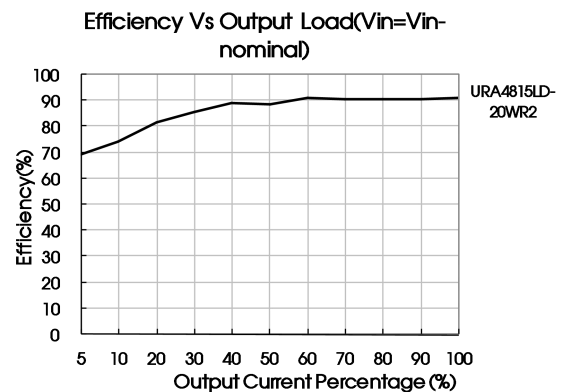
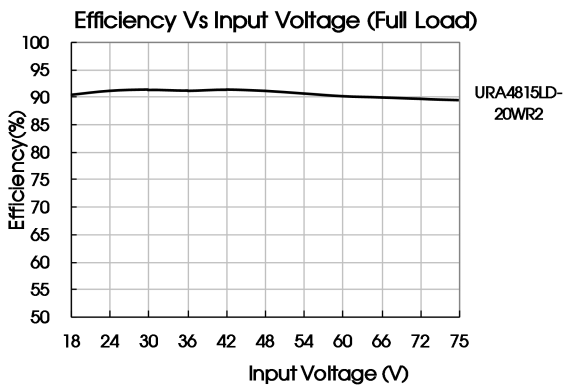
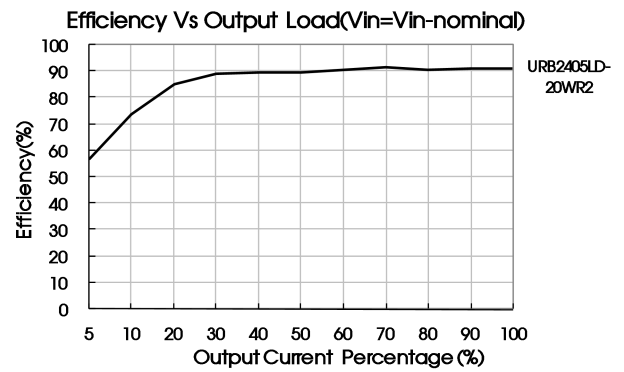
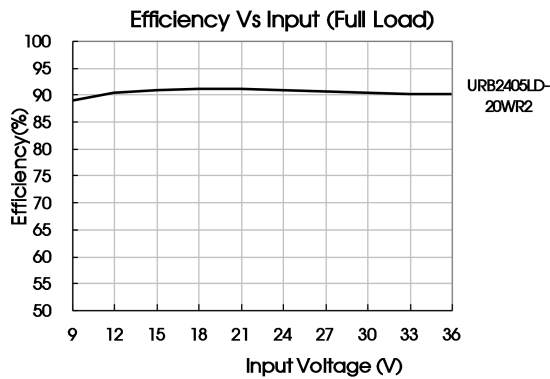

Fig. 1



Design Reference

1. Typical application

All the DC/DC converters of this series are tested according to the recommended circuit (see Fig. 2) before delivery.

If a further decrease of the input and output ripple is required, properly increase the input & output of additional capacitors  $C_{in}$  and  $C_{out}$  or select capacitors of low equivalent impedance, and ensure the capacitance should be lower than the max. capacitive load of the product.

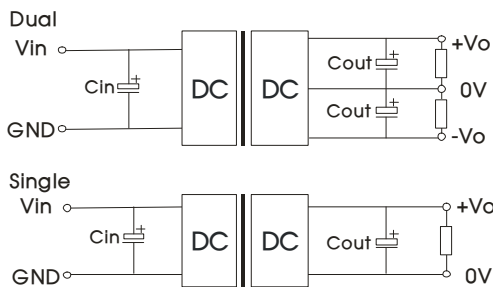

Fig. 2

|        |       | Vout(VDC) | Cin(μF) | Cout(μF) |
|--------|-------|-----------|---------|----------|
| Dual   | ±5    | ±12/±15   | 100     | 220      |
|        |       |           |         | 100      |
| Single | 3.3/5 | 9/12/15   | 100     | 470      |
|        |       |           |         | 220      |
|        | 24    |           |         | 100      |

2. EMC solution-recommended circuit

Parameter description

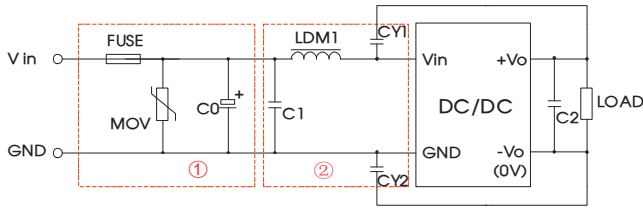

Fig. 3

Notes: Part ① in the Fig. 3 is used for EMS test and part ② for EMI filtering; selected based on needs.

| Model    | Vin:24V                                  | Vin:48V    |
|----------|--|------------|
| FUSE     | Choose according to actual input current |            |
| MOV      | S14K35                                   | S14K60     |
| C0       | 330μF/50V                                | 330μF/100V |
| C1       | 1μF/50V                                  | 1μF/100V   |
| C2       | Refer to the Cout in Fig.2               |            |
| LDM1     | 4.7μH                                    |            |
| CY1, CY2 | 1nF/2KV                                  |            |

EMC solution-recommended circuit PCB layout

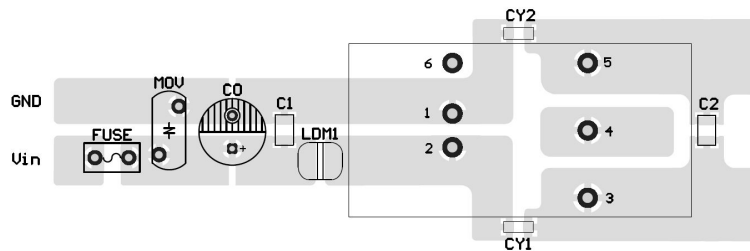
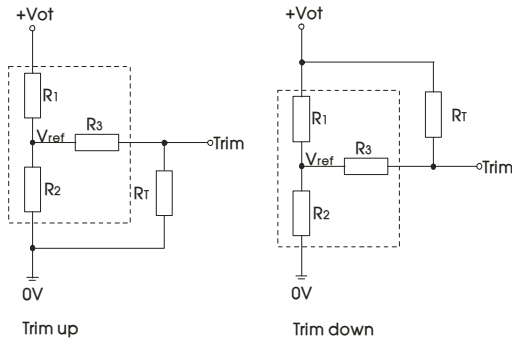

Fig. 4

Note: the min. distance of the bonding pads between input & output isolation capacitors (CY1/CY2) shall be ≥ 2mm.

1. Application of Trim and calculation of Trim resistance



Applied circuits of Trim (Part in broken line is the interior of models)

Calculation formula of Trim resistance:

$$\begin{aligned} \text{up: } R_T &= \frac{aR_2}{R_2-a} - R_3 & a &= \frac{V_{ref}}{V_{o'} - V_{ref}} \cdot R_1 \\ \text{down: } R_T &= \frac{aR_1}{R_1-a} - R_3 & a &= \frac{V_{o'} - V_{ref}}{V_{ref}} \cdot R_2 \end{aligned}$$

Note: Leave open if not used.  $R_T$ : Resistance of Trim.  $a$ : User-defined parameter, no actual meanings.

| Vout(V) | R1(KΩ) | R2(KΩ) | R3(KΩ) | Vref(V) |
|---------|--------|--------|--------|---------|
| 3.3     | 4.801  | 2.863  | 15     | 1.24    |
| 5       | 2.883  | 2.864  | 10     | 2.5     |
| 9       | 7.500  | 2.864  | 15     | 2.5     |
| 12      | 10.971 | 2.864  | 17.8   | 2.5     |
| 15      | 14.497 | 2.864  | 17.8   | 2.5     |
| 24      | 24.872 | 2.863  | 20     | 2.5     |

3. It is not allowed to connect modules output in parallel to enlarge the power

4. For more information about Mornsun EMC Filter products, please visit [www.mornsun-power.com](http://www.mornsun-power.com) to download the Selection Guide of EMC Filter

Dimensions and Recommended Layout(Without heatsink)

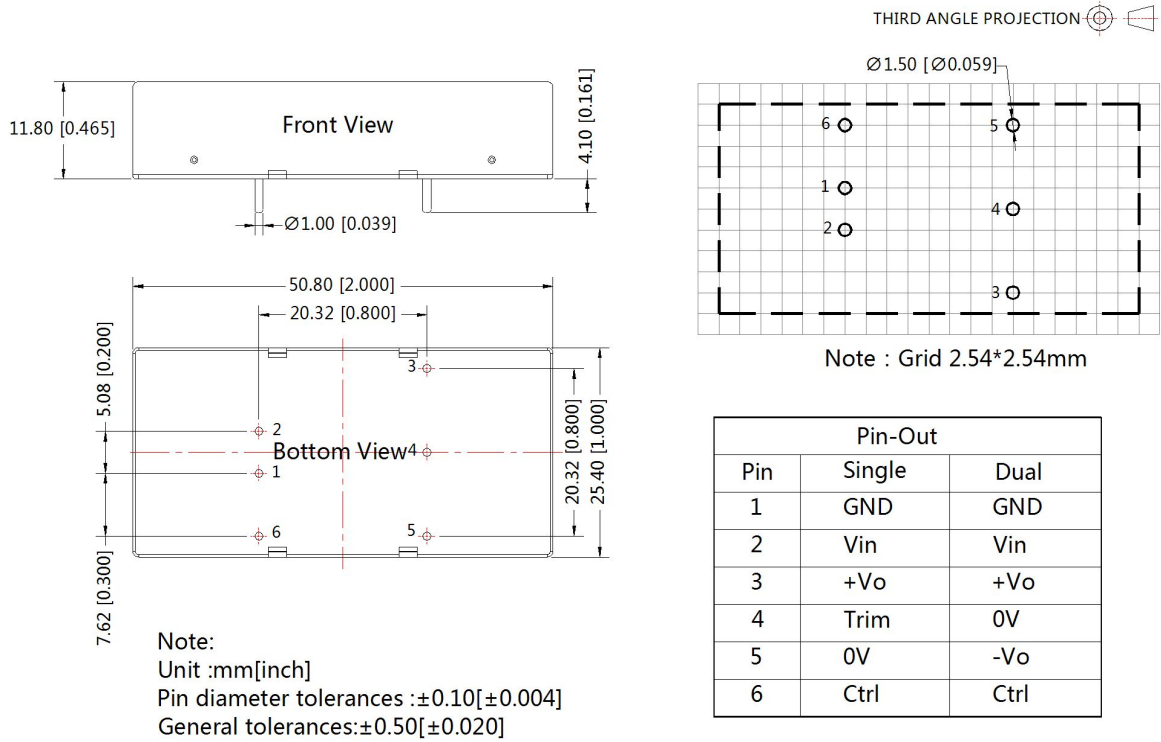

Dimensions (With heatsink)

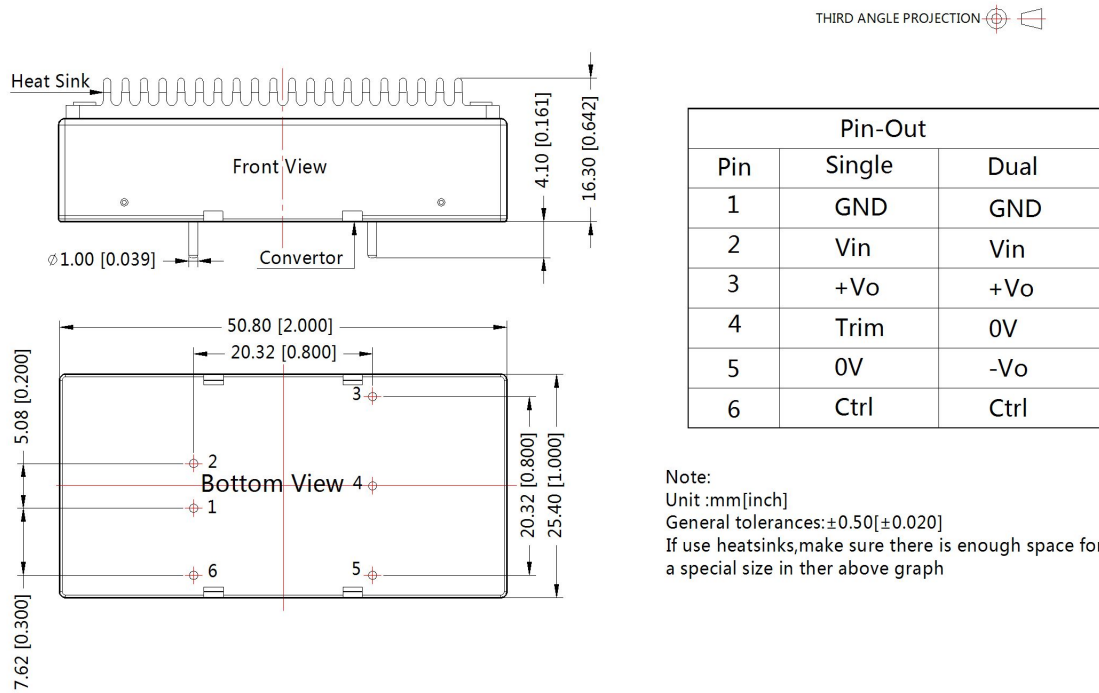

A2S Wiring Package Dimensions(Without heatsink)

THIRD ANGLE PROJECTION

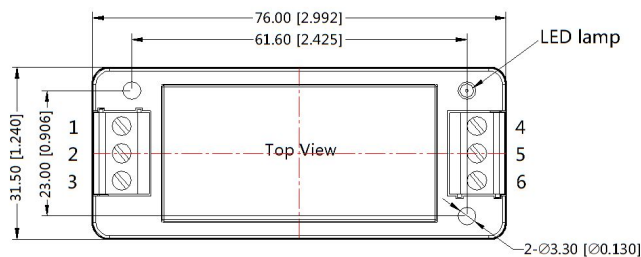

| Pin-Out |      |     |     |     |      |     |
|---------|------|-----|-----|-----|------|-----|
| Pin     | 1    | 2   | 3   | 4   | 5    | 6   |
| Dual    | Ctrl | GND | Vin | -Vo | 0V   | +Vo |
| Single  | Ctrl | GND | Vin | 0V  | Trim | +Vo |

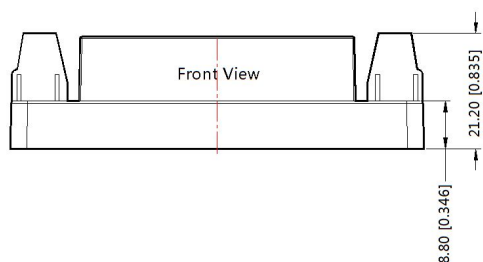

Note:  
 Unit:mm[inch]  
 Wire range : 24~12 AWG  
 General tolerances:±0.50[±0.020]

A2S Wiring Package Dimensions(With heatsink)

THIRD ANGLE PROJECTION

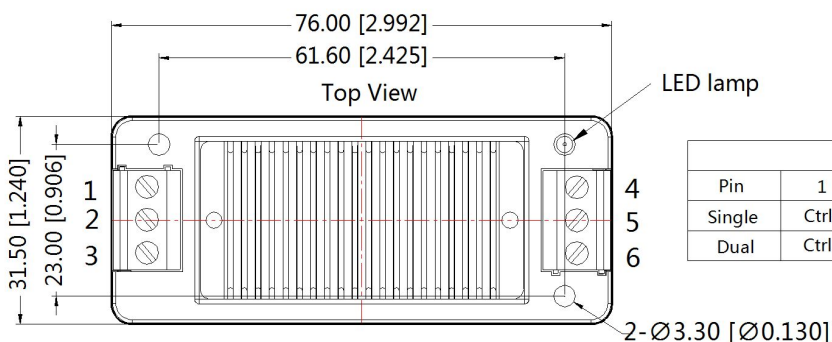

| Pin-Out |      |     |     |     |      |     |
|---------|------|-----|-----|-----|------|-----|
| Pin     | 1    | 2   | 3   | 4   | 5    | 6   |
| Single  | Ctrl | GND | Vin | 0V  | Trim | +Vo |
| Dual    | Ctrl | GND | Vin | -Vo | 0V   | +Vo |

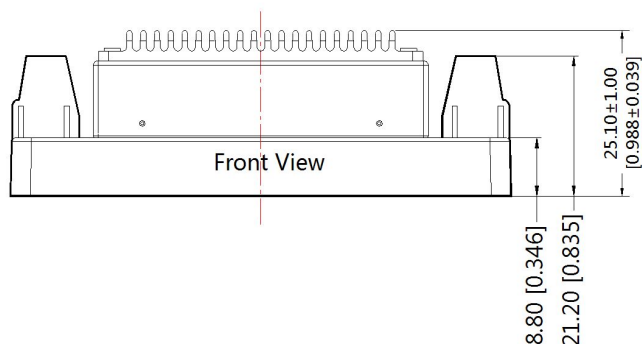

Note:  
 Unit:mm[inch]  
 Wire range:24~12 AWG  
 General tolerances:±0.50[±0.020]

A4S Rail Package Dimensions(Without heatsink)

THIRD ANGLE PROJECTION

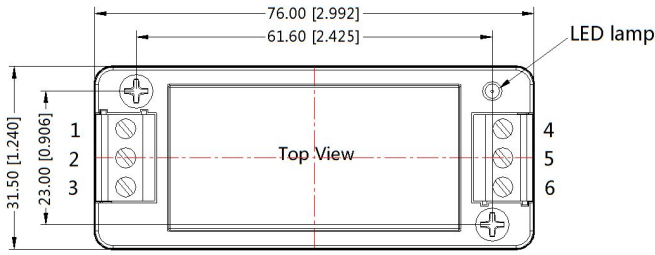

| Pin-Out |      |     |     |     |      |     |
|---------|------|-----|-----|-----|------|-----|
| Pin     | 1    | 2   | 3   | 4   | 5    | 6   |
| Dual    | Ctrl | GND | Vin | -Vo | 0V   | +Vo |
| Single  | Ctrl | GND | Vin | 0V  | Trim | +Vo |

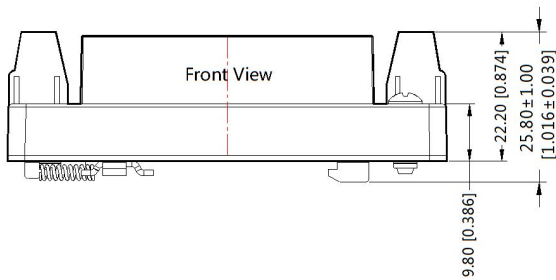

Note:  
 Unit:mm[inch]  
 Wire range : 24~12 AWG  
 General tolerances:±0.50[±0.020]

A4S Rail Package Dimensions(With heatsink)

THIRD ANGLE PROJECTION

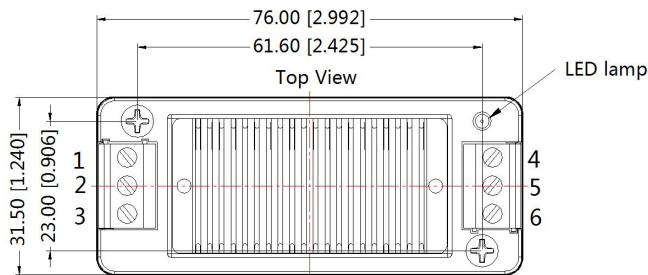

| Pin-Out |      |     |     |     |      |     |
|---------|------|-----|-----|-----|------|-----|
| Pin     | 1    | 2   | 3   | 4   | 5    | 6   |
| Single  | Ctrl | GND | Vin | 0V  | Trim | +Vo |
| Dual    | Ctrl | GND | Vin | -Vo | 0V   | +Vo |

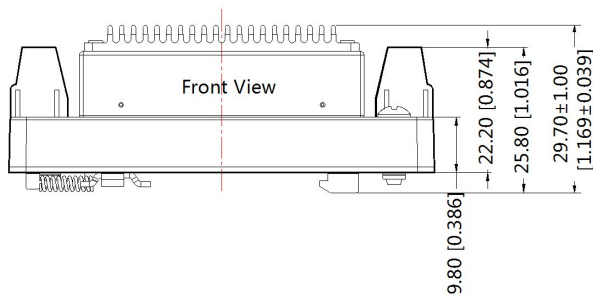

Note:  
 Unit:mm[inch]  
 Wire range:24~12 AWG  
 General tolerances:±0.50[±0.020]



Notes:

1. Packing information please refer to Product Packing Information which can be downloaded from [www.mornsun-power.com](http://www.mornsun-power.com). Horizontal Packing Bag Number : 58200035(without heatsink),58200051(with heatsink), A2S/A4S Packing Bag Number: 58220022;
2. Recommend to use module with more than 5% load, if not, the ripple of the product may exceeds the specification, but does not affect the reliability of the product;
3. The recommended unbalance degree of the dual output module load is  $\leq \pm 5\%$ ; if the degree exceeds  $\pm 5\%$ , than the product performance cannot be guaranteed to comply with all parameters in the datasheet. Please contact our technicians directly for specific information;
4. The maximum capacitive load offered were tested at nominal input voltage and full load;
5. Unless otherwise specified, parameters in this datasheet were measured under the conditions of  $T_a=25^\circ\text{C}$ , humidity $<75\%$  with nominal input voltage and rated output load;
6. All index testing methods in this datasheet are based on our Company's corporate standards;
7. The performance parameters of the product models listed in this manual are as above, but some parameters of non-standard model products may exceed the requirements mentioned above. Please contact our technicians directly for specific information;
8. We can provide product customization service;
9. Specifications are subject to change without prior notice.

## Mornsun Guangzhou Science & Technology Co., Ltd.

Address: No. 5, Kehui St. 1, Kehui Development Center, Science Ave., Guangzhou Science City, Luogang District, Guangzhou, P. R. China  
Tel: 86-20-38601850-8801 Fax: 86-20-38601272 E-mail: [info@mornsun.cn](mailto:info@mornsun.cn)