

# USER'S MANUAL

TBM251  
TBM252  
TBM255  
TBM257

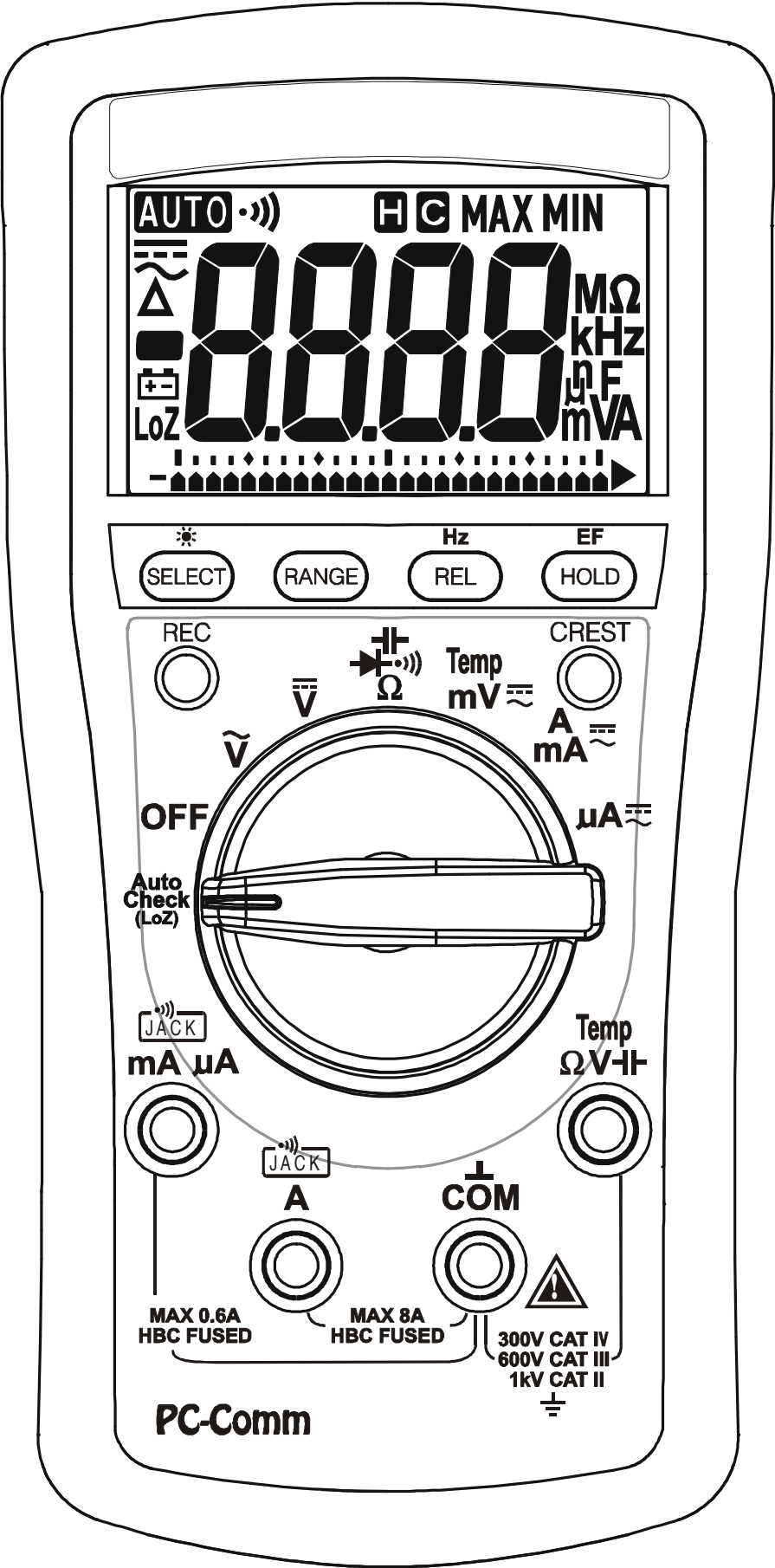

HellermannTyton



## 1) SAFETY

### Terms in this manual

**WARNING** identifies conditions and actions that could result in serious injury or even death to the user.

**CAUTION** identifies conditions and actions that could cause damage or malfunction in the instrument.

This manual contains information and warnings that must be followed for operating the instrument safely and maintaining the instrument in a safe operating condition. If the instrument is used in a manner not specified by the manufacturer, the protection provided by the instrument may be impaired. The meter is intended only for indoor use.

The meter protection rating, against the users, is double insulation per IEC61010-1 2nd Ed., EN61010-1 2nd Ed., UL61010-1 2nd Ed. and CAN/CSA C22.2 No. 61010.1-0.92 to Category II 1000V, CAT III 600V and CAT IV 300V AC & DC.

Terminals (to COM) measurement category:

V : Category II 1000V, CAT III 600V and CAT IV 300V AC & DC.

mA $\mu$ A : Category III 500Vac and 300Vdc.

A : Category III 600Vac and 300Vdc.

### Per IEC61010-1 2nd Ed. (2001) Measurement Category

**Measurement Category IV (CAT IV)** is for measurements performed at the source of the low-voltage installation. Examples are electricity meters and measurements on primary overcurrent protection devices and ripple control units.

**Measurement Category III (CAT III)** is for measurements performed in the building installation. Examples are measurements on distribution boards, circuit-breakers, wiring, including cables, bus-bars, junction boxes, switches, socket-outlets in the fixed installation, and equipment for industrial use and some other equipment, for example, stationary motors with permanent connection to the fixed installation.

**Measurement Category II (CAT II)** is for measurements performed on circuits directly connected to the low voltage installation. Examples are measurements on household appliances, portable tools and similar equipment.







**WARNING**

To reduce the risk of fire or electric shock, do not expose this product to rain or moisture. To avoid electrical shock hazard, observe the proper safety precautions when working with voltages above 60 VDC or 30 VAC rms. These voltage levels pose a potential shock hazard to the user. Do not touch test lead tips or the circuit being tested while power is applied to the circuit being measured. Keep your fingers behind the finger guards of the test leads during measurement. Inspect test leads, connectors, and probes for damaged insulation or exposed metal before using the instrument. If any defects are found, replace them immediately. Do not measure any current that exceeds the current rating of the protection fuse. Do not attempt a current measurement to any circuit where the open circuit voltage is above the protection fuse voltage rating. Suspected open circuit voltage should be checked with voltage functions. Never attempt a voltage measurement with the test lead inserted into the  $\mu\text{A}/\text{mA}$  or A input jack. Only replace the blown fuse with the proper rating as specified in this manual.

**CAUTION**

Disconnect the test leads from the test points before changing functions. Always set the instrument to the highest range and work downward for an unknown value when using manual ranging mode.

**INTERNATIONAL ELECTRICAL SYMBOLS**

	Caution ! Refer to the explanation in this Manual
	Caution ! Risk of electric shock
	Earth (Ground)
	Double Insulation or Reinforced insulation
	Fuse
	AC--Alternating Current
	DC--Direct Current

**2) CENELEC DIRECTIVES**

The instruments conform to CENELEC Low-voltage directive 2006/95/EC and Electromagnetic compatibility directive 2004/108/EC

### 3) PRODUCT DESCRIPTION

Note: Top of the line model is used as representative for illustration purposes. Please refer to your respective model for function availability.

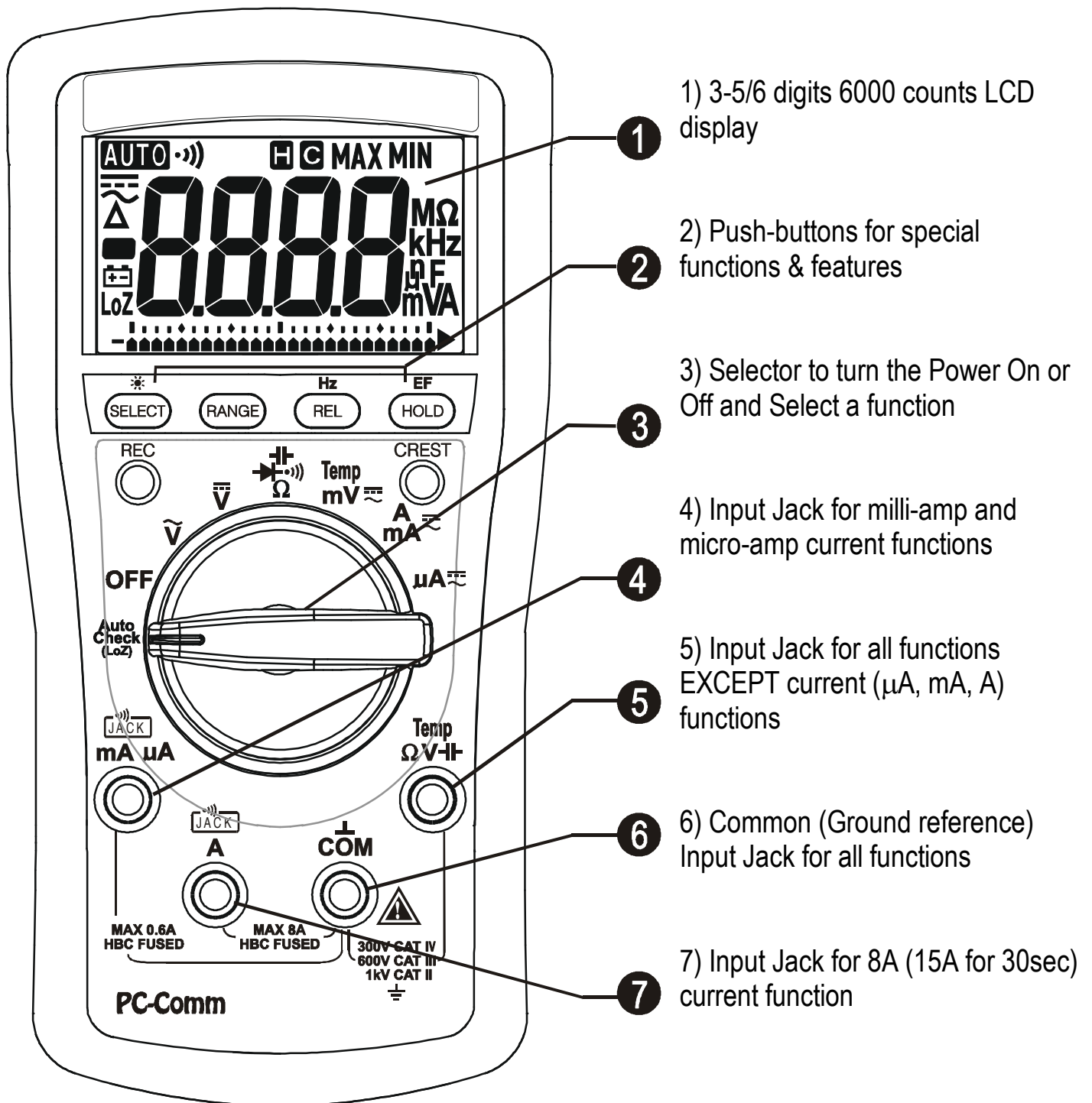

#### Analog bar-graph

The analog bar graph provides a visual indication of measurement like a traditional analog meter needle. It is excellent in detecting faulty contacts, identifying potentiometer clicks, and indicating signal spikes during adjustments.

### **Average sensing RMS calibrated**

RMS (Root-Mean-Square) is the term used to describe the effective or equivalent DC value of an AC signal. Most digital multimeters use average sensing RMS calibrated technique to measure RMS values of AC signals. This technique is to obtain the average value by rectifying and filtering the AC signal. The average value is then scaled upward (calibrated) to read the RMS value of a sine wave. In measuring pure sinusoidal waveform, this technique is fast, accurate and cost effective. In measuring non-sinusoidal waveforms, however, significant errors can be introduced because of different scaling factors relating average to RMS values.

### **True RMS**

True RMS is a term which identifies a DMM that responds accurately to the effective RMS value regardless of the waveforms such as: square, sawtooth, triangle, pulse trains, spikes, as well as distorted waveforms with the presence of harmonics. Harmonics may cause :

- 1)Overheated transformers, generators and motors to burn out faster than normal
- 2)Circuit breakers to trip prematurely
- 3)Fuses to blow
- 4)Neutrals to overheat due to the triplen harmonics present on the neutral
- 5)Bus bars and electrical panels to vibrate

### **Crest Factor**

Crest Factor is the ratio of the Crest (instantaneous peak) value to the True RMS value, and is commonly used to define the dynamic range of a True RMS DMM. A pure sinusoidal waveform has a Crest Factor of 1.4. A badly distorted sinusoidal waveform normally has a much higher Crest Factor.

### **NMRR (Normal Mode Rejection Ratio)**

NMRR is the DMM's ability to reject unwanted AC noise effect that can cause inaccurate DC measurements. NMRR is typically specified in terms of dB (decibel). This series has a NMRR specification of >60dB at 50 and 60Hz, which means a good ability to reject the effect of AC noise in DC measurements.

### **CMRR (Common Mode Rejection Ratio)**

Common mode voltage is voltage present on both the COM and VOLTAGE input terminals of a DMM, with respect to ground. CMRR is the DMM's ability to reject common mode voltage effect that can cause digit rolling or offset in voltage measurements. This series has a CMRR specifications of >60dB at DC to 60Hz in ACV function; and >100dB at DC, 50 and 60Hz in DCV function. If neither NMRR nor CMRR specification is specified, a DMM's performance will be uncertain.

## **4) OPERATION**

### **CAUTION**

*Before and after hazardous voltage measurements, test the voltage function on a known source such as line voltage to determine proper meter functioning.*

## Auto Check V-Ω

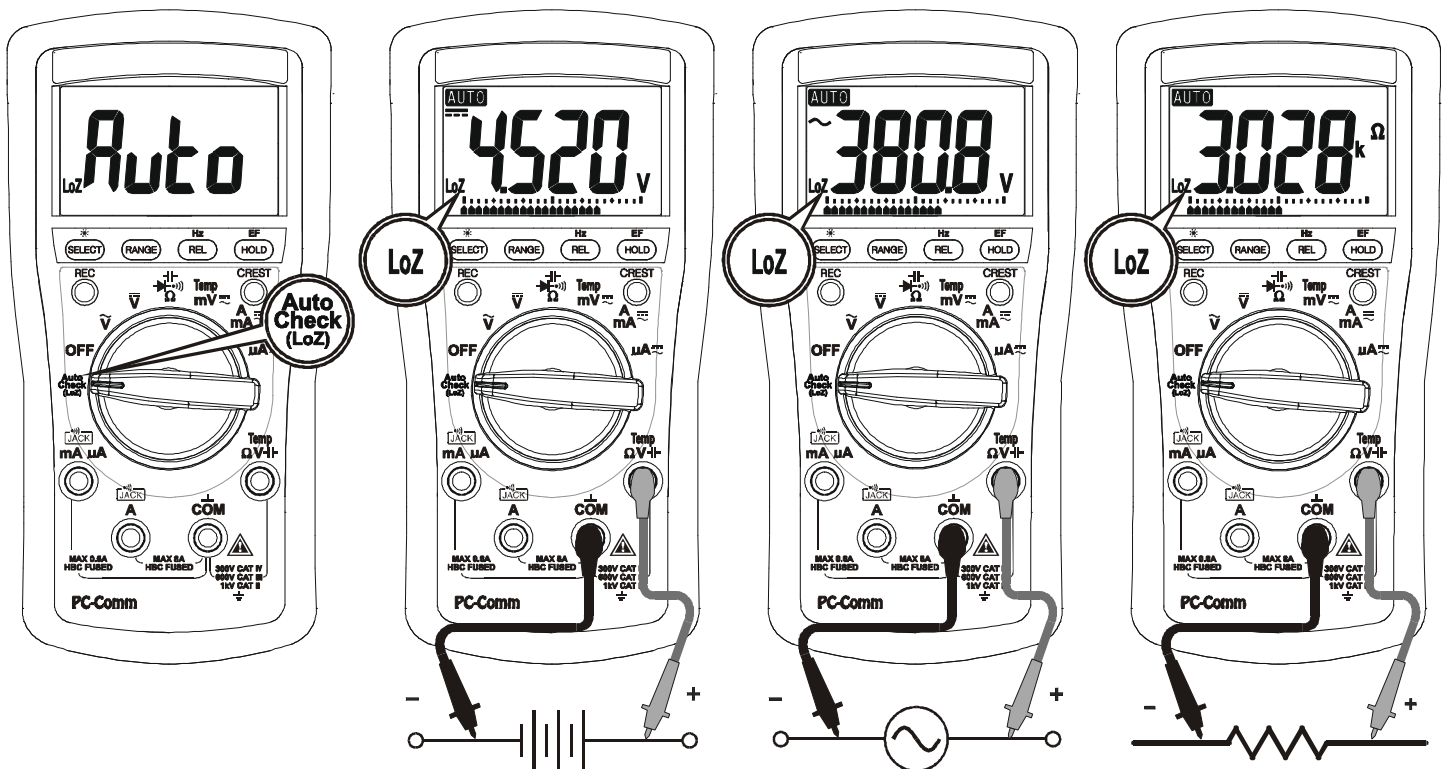

### AutoCheck™ mode (model 257 & 255 only)

This innovative **AutoCheck™** feature automatically selects measurement function of DCV, ACV or Resistance ( $\Omega$ ) based on the input via the test leads.

- With no input, the meter displays “Auto” when it is ready.
- With no voltage signal but a resistance below  $10\text{M}\Omega$  (nominal) is present, the meter displays the resistance value. When the resistance is below “Audible Threshold”, the meter further gives a continuity beep tone.
- When a signal above the voltage threshold of 1V DC or AC up to the rated 1000V is present, the meter displays the voltage value in appropriate DC or AC, whichever larger in peak magnitude.

#### Note:

**\*Range-Lock and Function-Lock Feature:** When a measurement reading is being displayed in AutoCheck™ mode, press the **RANGE** or **SELECT** button momentarily 1 time can lock the range or function it was in. Press the button momentarily repeatedly to step through the ranges or functions.

**\*As Hazardous-Alert:** When making resistance measurements in AutoCheck™ mode, an unexpected display of voltage readings alerts you that the object under test is being energized.

**\*Ghost-voltage Buster:** Ghost-voltages are unwanted stray signals coupled from adjacent hard signals, which confuse common multimeter voltage measurements. Our AutoCheck™ mode provides low (ramp-up) input impedance (approx.  $2.5\text{k}\Omega$  at low voltage) to drain ghost voltages leaving mainly hard signal values on meter readings. It is an invaluable feature for precise indication of hard signals, such as distinguishing between hot and open wires (to ground) in electrical installation applications.

**WARNING:**

AutoCheck™ mode input impedance increases abruptly from initial  $2.5k\Omega$  to a few hundred  $k\Omega$ 's on high voltage hard signals. "LoZ" displays on the LCD to remind the users of being in such low impedance mode. Peak initial load current, while probing 1000VAC for example, can be up to 566mA ( $1000V \times 1.414 / 2.5k\Omega$ ), decreasing abruptly to approx. 3.8mA ( $1000V \times 1.414 / 375k\Omega$ ) within a fraction of a second. Do not use AutoCheck™ mode on circuits that could be damaged by such low input impedance. Instead, use rotary selector  $\tilde{V}$  or  $\bar{V}$  high input impedance voltage modes to minimize loading for such circuits.

**DCV, ACV, & Line Frequency functions**

Press the Hz push-button for one second or more to activate or to exit Hz.

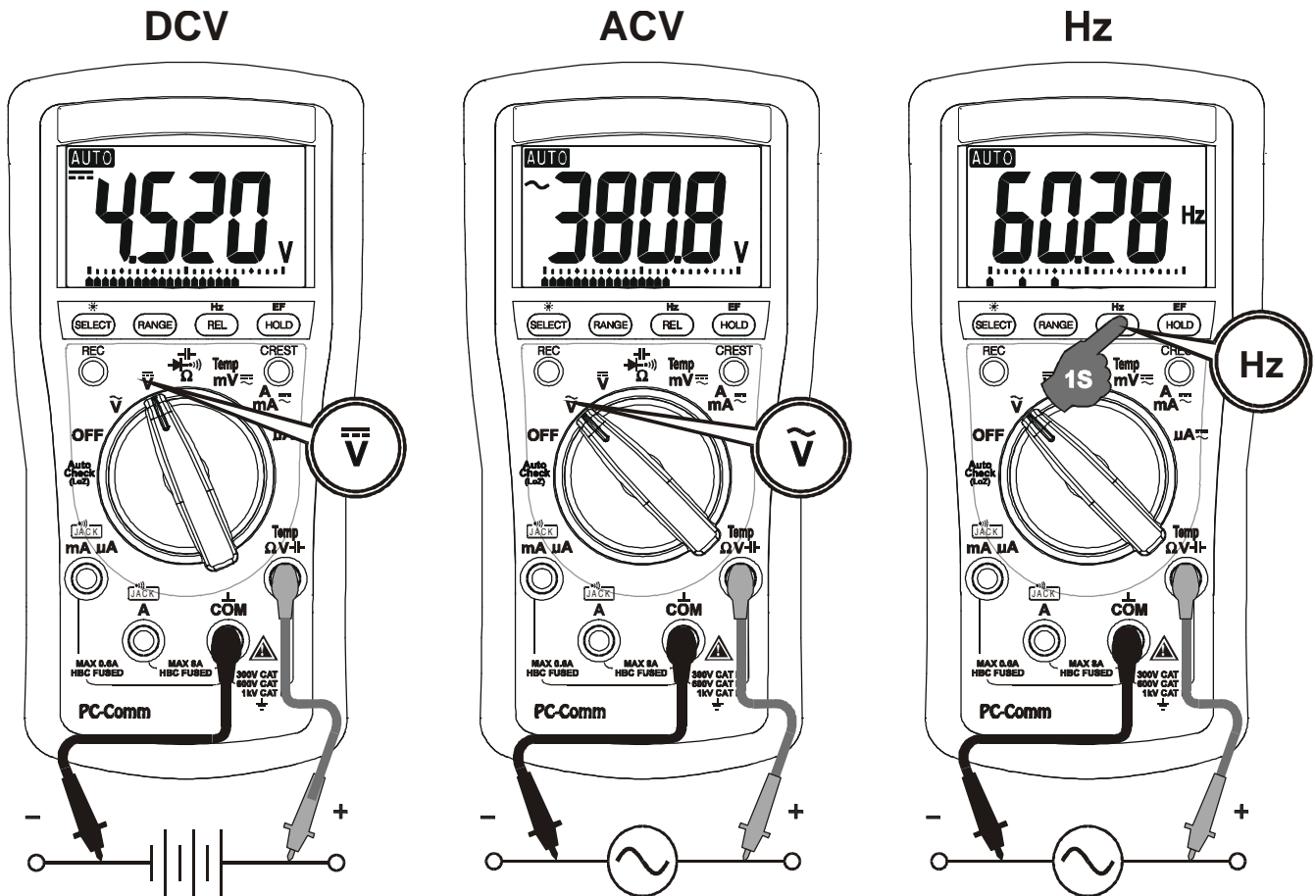
**Note:**

\*Input sensitivity varies automatically with function range selected before activating the Hz function. 6V function range has the highest and the 1000V range has the lowest. It is recommended to first measure the signal voltage (or current) level then activate the Hz function in that voltage (or current) range to automatically set the most appropriate trigger level. You can also press the **RANGE** button momentarily to select another trigger level manually. If the Hz reading becomes unstable, select lower sensitivity to avoid electrical noise. If the reading shows zero, select higher sensitivity.

\*Number of Bar-graph pointer is used to indicate input range (sensitivity) selected. 1/2/3/4 pointers indicate 6/60/600/1000V, 6/10/-/A, 60/600/-/mA or 600/6000/-/uA is selected in corresponding V, A, mA or uA function respectively. ( "-" means range not available)

\*The **Hz** of **mV** function is designed specially for logic level (3V or 5V family) frequency measurement.

## $\Omega$ Resistance, $\rightarrow$ ) Continuity, $\dashv$ Capacitance (model 257, 255 & 252 only), & $\rightarrow$ Diode test functions

Press the **SELECT** button momentarily to select the subject functions in sequence. Last selection will be saved as power up default for repeat measurement convenience.

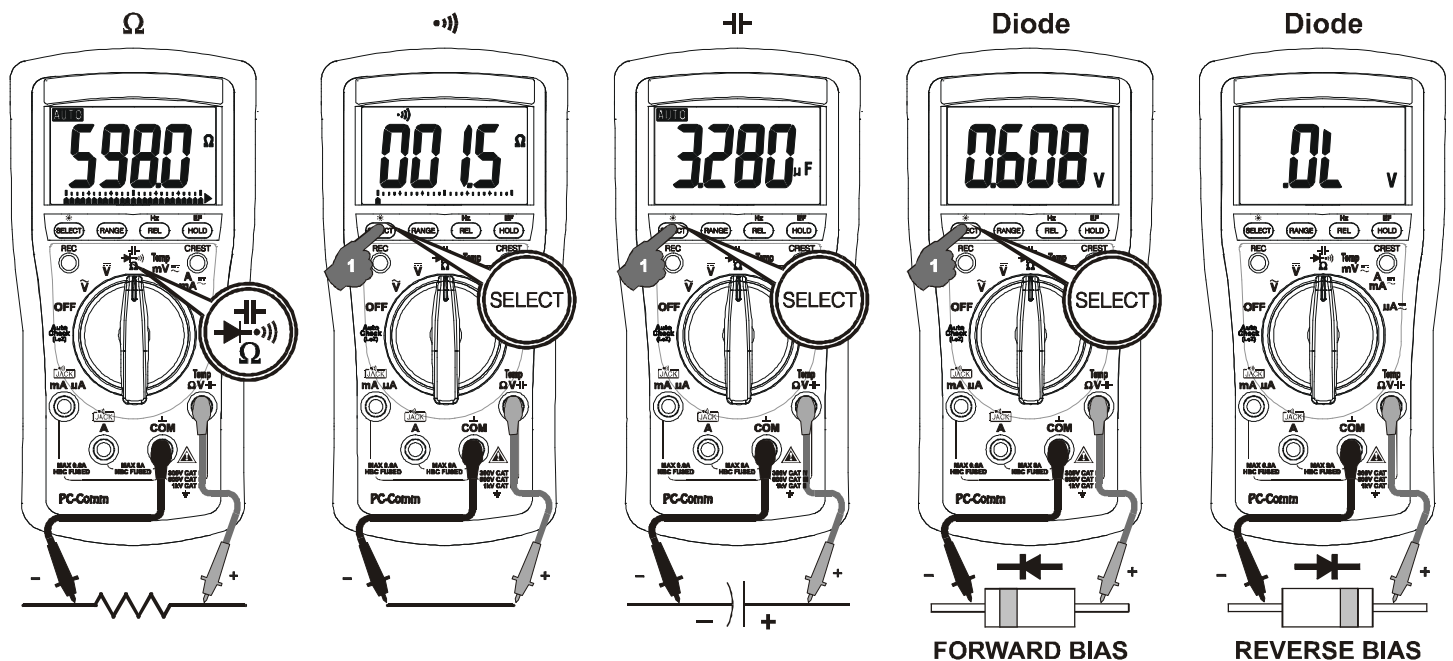

### CAUTION

Discharge capacitors before making any measurement. Large value capacitors should be discharged through an appropriate resistance load.

### CAUTION

Using resistance and continuity function in a live circuit will produce false results and may damage the instrument. In many cases the suspected component must be disconnected from the circuit to obtain an accurate reading

$\rightarrow$ ) Continuity function is convenient for checking wiring connections and operation of switches. A continuous beep tone indicates a complete wire.

Normal forward voltage drop (forward biased) for a good silicon diode is between 0.400V to 0.900V. A reading higher than that indicates a leaky diode (defective). A zero reading indicates a shorted diode (defective). An OL indicates an open diode (defective). Reverse the test leads connections (reverse biased) across the diode. The digital display shows OL if the diode is good. Any other readings indicate the diode is resistive or shorted (defective).

### DCmV, ACmV, Temperature $^{\circ}\text{C}$ & $^{\circ}\text{F}$ functions (model 257, 255 & 252 only)

Press the **SELECT** button momentarily to select the subject functions in sequence. Last selection will be saved as power up default for repeat measurement convenience.



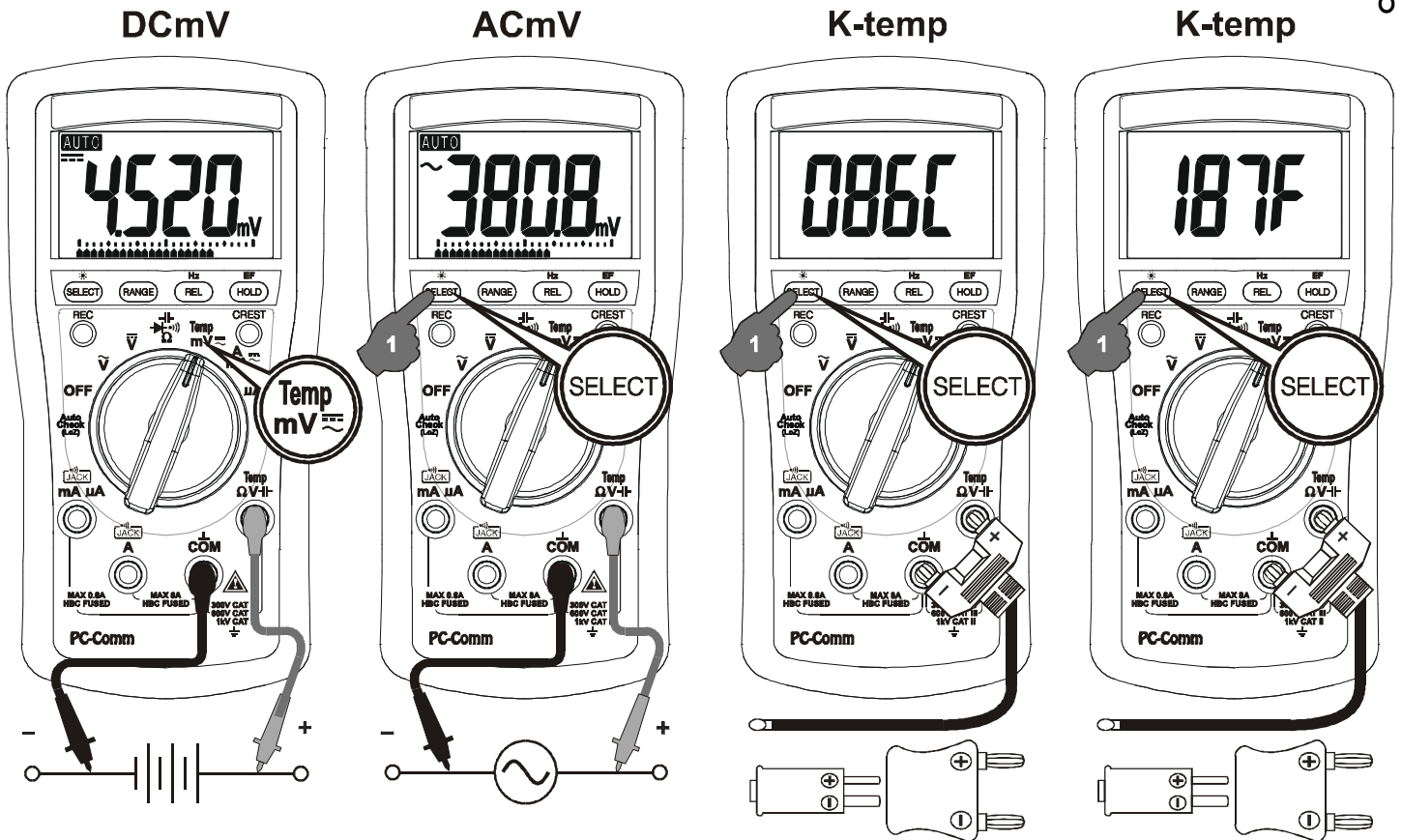

Note: Be sure to insert the banana plug K-type temperature bead probe Bkp60 with correct  $+$   $-$  polarities. You can also use a plug adapter Bkb32 (Optional purchase) with banana pins to K-type socket to adapt other standard K type mini plug temperature probes.

### $\mu$ A, mA, and A Current functions

Press **SELECT** button momentarily to toggle between DC and AC. Last selection will be saved as power up default for repeat measurement convenience.

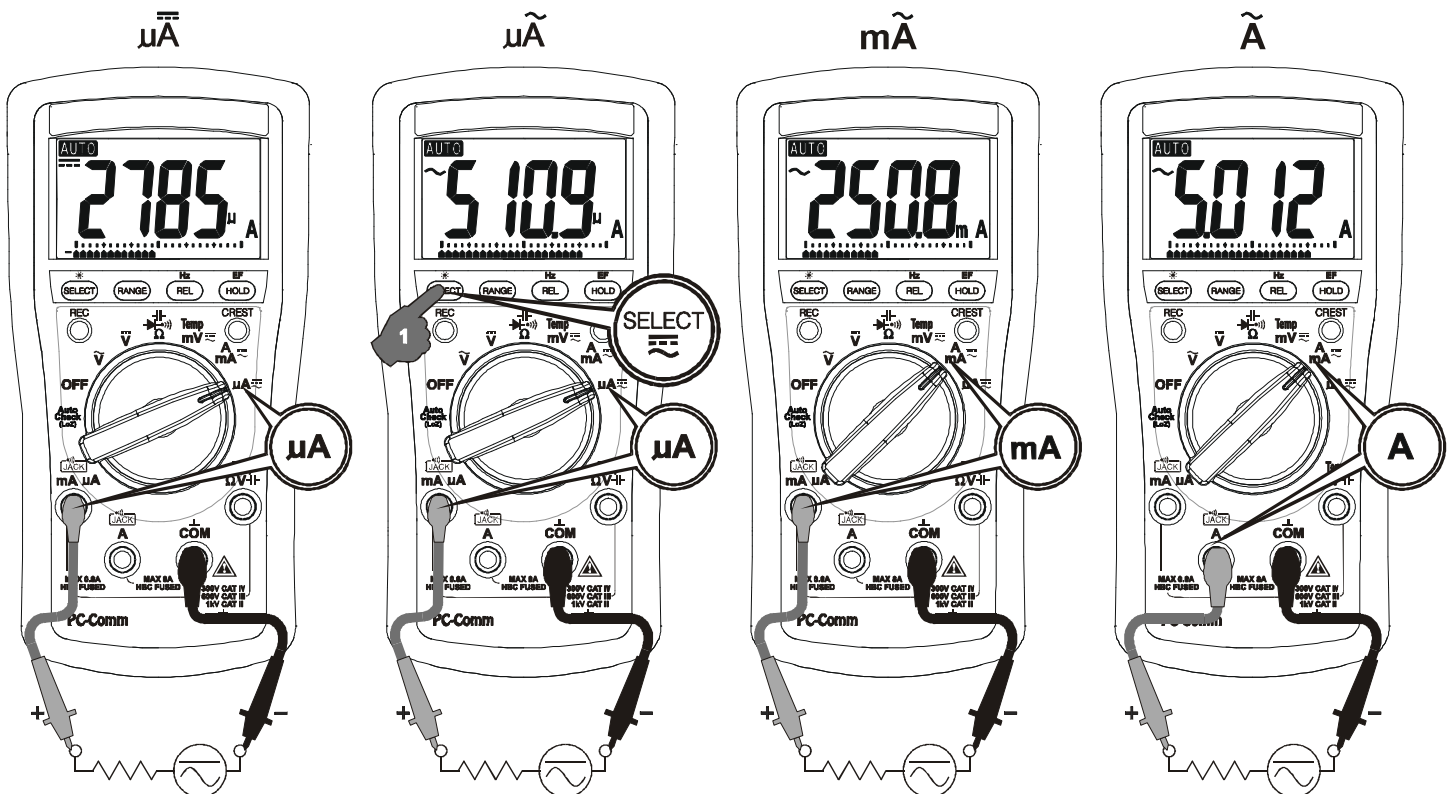

\*Note: When measuring a 3-phase system, special attention should be taken to the phase-to-phase voltage which is significantly higher than the phase-to-earth voltage. To avoid exceeding the voltage rating of the protection fuse(s) accidentally, always consider the phase-to-phase voltage as the working voltage for the protection fuse(s).

### Electric Field EF-Detection

At Volt or Current function, press the **EF** button for one second or more and release to toggle to EF-Detection feature. The meter displays "E.F." when it is ready. Signal strength is indicated as a series of bar-graph segments on the display plus variable beep tones.

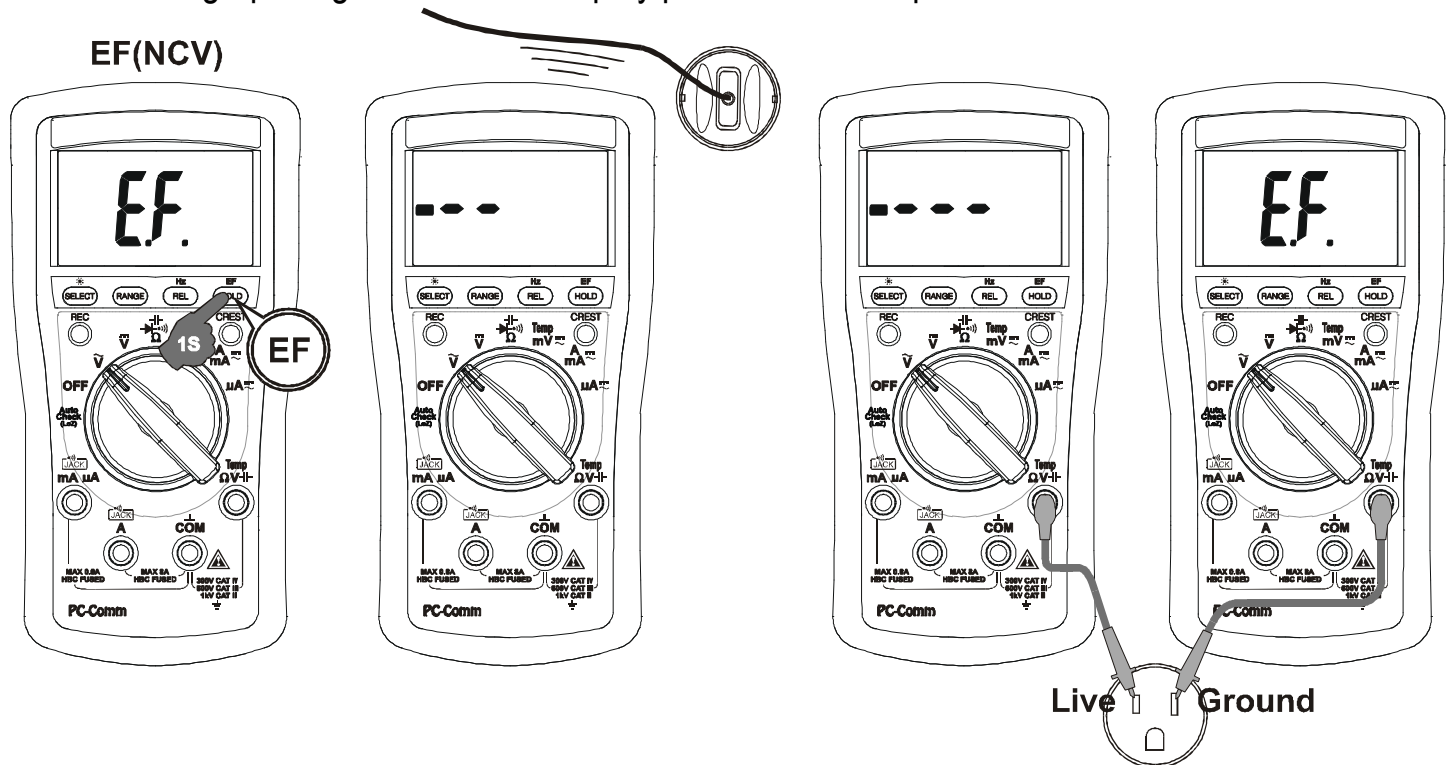

- **Non-Contact EF-Detection:** An antenna is located along the top-right end of the meter, which detects electric field surrounds current-carrying conductors. It is ideal for tracing live wiring connections, locating wiring breakage and to distinguish between live or earth connections.
- **Probe-Contact EF-Detection:** For more precise indication of live wires, such as distinguishing between live and ground connections, use the Red (+) test probe for direct contact measurements.

### PC computer interface capabilities

The instrument equips with an optical isolated interface port at the meter back for data communication. Press **HOLD** button while turning the meter on to enable meter PC-COMM output. Optional purchase PC interface kit BRUA20X is required to connect the meter to the PC computer RS232 or USB ports.

### MAX/MIN at Fast 20/s measurement mode (model 257 & 255 only)

Press **REC** button momentarily to activate MAX/MIN recording mode. The LCD "MAX MIN" turn on, and the reading update rate will be increased to 20/second. The meter beeps when new MAX (maximum) or MIN (minimum) reading is updated. Press the button momentarily to read the MAX and MIN readings in sequence. Press the button for 1 second or more to exit MAX/MIN recording mode. Auto-ranging remains, and Auto-Power-Off is disabled automatically in this mode.

### 5ms CREST capture mode (model 257 & 255 only)

Press **CREST** button momentarily to activate CREST (Instantaneous Peak-Hold) mode to capture voltage or current signal duration as short as 5ms. The LCD “C” & “MAX” turn on. Press the button momentarily to read the MAX and MIN readings in sequence. Press the button for 1 second or more to exit CREST capture mode. Auto-ranging and Auto-Power-Off are disabled automatically in this mode.

### Backlight LCD display (model 257 & 255 only)

Press the **SELECT** button for 1 second or more to toggle the LCD backlight. The backlight will also be turned off automatically after 32 seconds to extend battery life.

### Hold

The hold feature freezes the display for later view. Press the **HOLD** button momentarily to toggle the hold feature.

### Relative Zero ( $\Delta$ ) mode

Relative zero allows the user to offset the meter consecutive measurements with the displaying reading as the reference value. Practically all displaying readings can be set as relative reference value including MAX/MIN feature readings. Press the **REL** button momentarily to toggle relative zero mode.

### Manual or Auto-ranging

Press the **RANGE** button momentarily to select manual-ranging, and the meter will remain in the range it was in, the LCD **AUTO** turns off. Press the button momentarily again to step through the ranges. Press and hold the button for 1 second or more to resume auto-ranging.

Note: Manual ranging feature is not available in **Hz** and **Hz** functions.

### Set Beeper Off

Press the **RANGE** button while turning the meter on to temporarily disable the Beeper feature. Turn the rotary switch OFF and then back on to resume.

### Beep-Jack™ Input Warning

The meter beeps as well as displays “InEr” to warn the user against possible damage to the meter due to improper connections to the  $\mu$ A, mA, or A input jacks when other function (like voltage function) is selected.

### Auto-Power-Off (APO)

The Auto-Power-Off (APO) mode turns the meter off automatically to extend battery life after approximately 34 minutes of no rotary switch or push button operations. To wake up the meter from APO, press the **SELECT**, **CREST** or **REC** button momentarily or turn the rotary switch OFF and then back on. Always turn the rotary switch to the OFF position when the meter is not in use

### Disabling Auto-Power-Off

Press the **SELECT** button while turning the meter on to temporarily disable the Auto-Power-Off (APO) feature. Turn the rotary switch OFF and then back on to resume.

## 5) MAINTENANCE WARNING

To avoid electrical shock, disconnect the meter from any circuit, remove the test leads from the input jacks and turn OFF the meter before opening the case. Do not operate with open case. Install only the same type of fuse or equivalent

### Calibration

Periodic calibration at intervals of one year is recommended to maintain meter accuracy. Accuracy is specified for a period of one year after calibration. If self-diagnostic message “C\_Er” is being displayed while powering on, some meter ranges might be largely out of specifications. To avoid mis-leading measurements, stop using the meter and send it for re-calibration. Refer to the LIMITED WARRANTY section for obtaining warranty or repairing service.

### Cleaning and Storage

Periodically wipe the case with a damp cloth and mild detergent; do not use abrasives or solvents. If the meter is not to be used for periods of longer than 60 days, remove the battery and store it separately

### Trouble Shooting

If the instrument fails to operate, check battery, fuses, leads, etc., and replace as necessary. Double check operating procedure as described in this user’s manual

If the instrument voltage-resistance input terminal has subjected to high voltage transient (caused by lightning or switching surge to the system) by accident or abnormal conditions of operation, the series fusible resistors will be blown off (become high impedance) like fuses to protect the user and the instrument. Most measuring functions through this terminal will then be open circuit. The series fusible resistors and the spark gaps should then be replaced by qualified technician. Refer to the LIMITED WARRANTY section for obtaining warranty or repairing service.

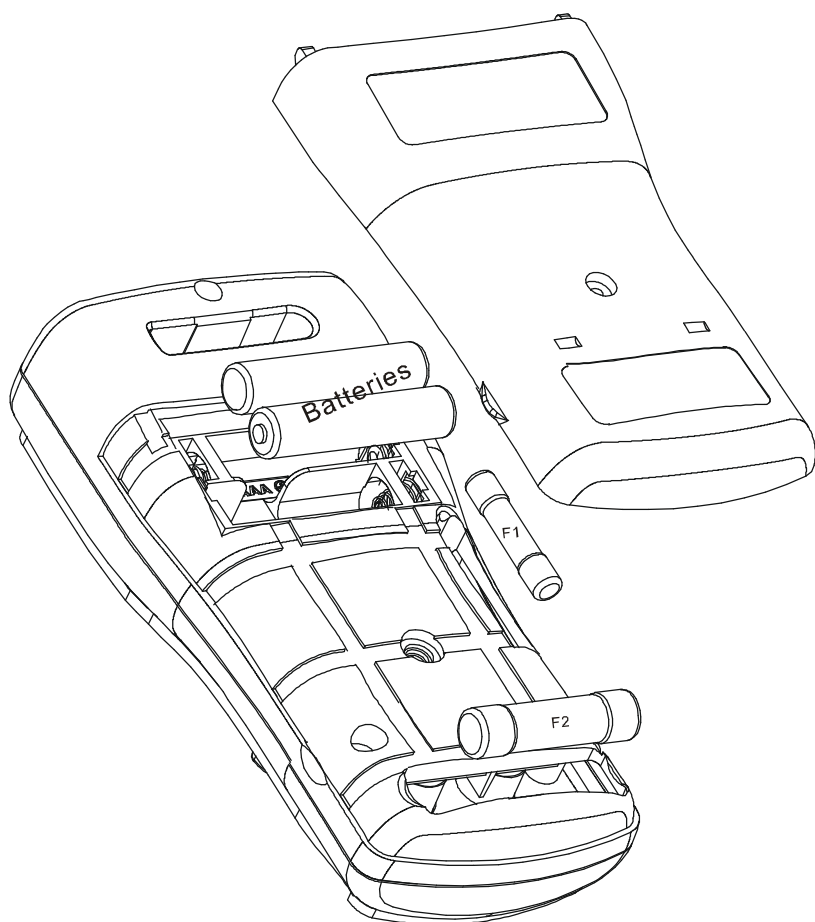

### Battery and Fuse replacement

*Battery use:* 1.5V AAA Size battery x 2

### *Fuses use:*

Fuse (FS1) for  $\mu$ mA current input:  
0.63A/500Vac, IR 50kA, F fuse

Fuse (FS2) for A current input:  
10A/600Vac, IR 100kA, F fuse

### ***Battery and Fuse replacement:***

Loosen the screw from the access cover of the case bottom. Lift the access cover. Replace the batteries or fuse. Re-fasten the screw.

**GENERAL SPECIFICATION****Display:** 3-5/6 digits 6,000 counts**Update Rate:** 5 per second nominal**24 Segments Bar graph:** 40 per second max**Operating Temperature:** 0°C to 40°C**Relative Humidity:** Maximum relative humidity 80% for temperature up to 31°C decreasing linearly to 50% relative humidity at 40°C**Altitude:** Operating below 2000m**Storage Temperature:** -20°C ~ 60°C, < 80% R.H. (with battery removed)**Temperature Coefficient:** Nominal 0.15 x (specified accuracy)/ °C @ (0°C ~ 18°C or 28°C ~ 40°C), or otherwise specified**Sensing:**

Model 251, 252 &amp; 255: Average sensing

Model 257: True RMS sensing

**Pollution Degree:** 2**Safety:** Double insulation per IEC61010-1 2nd Ed., EN61010-1 2nd Ed., UL61010-1 2nd Ed. & CAN/CSA C22.2 No. 61010.1-0.92 to Category II 1000V, CAT III 600V and CAT IV 300V AC & DC**Transient Protection:** 6.5kV (1.2/50µs surge)**Terminals (to COM) Measurement Category:**

V : Category II 1000V, CAT III 600V and CAT IV 300V AC &amp; DC.

mAµA : Category III 500Vac and 300Vdc.

A : Category III 600Vac and 300Vdc.

**E.M.C. :** Meets EN61326-1:2006 (EN55022, EN61000-3-2, EN61000-3-3, EN61000-4-2, EN61000-4-3, EN61000-4-4, , EN61000-4-5, EN61000-4-6, EN61000-4-8, EN61000-4-11)

In an RF field of 3V/m:

Capacitance function is not specified

Other function ranges:

Total Accuracy = Specified Accuracy + 100 digits

Performance above 3V/m is not specified

**Overload Protection:****µA & mA:** 0.63A/500Vac, IR 50kA @500Vac**A:** 10A/600Vac IR 100kA @600Vac**V:** 1050 Vrms, 1450 Vpeak**AutoCheck™, mV, Ohm & others:** 600 Vrms**Low Battery:** Below approx. 2.3V**Power Supply:** 1.5V AAA Size battery X 2**Power Consumption (typical):** 3.5mA**APO Consumption (typical):** 10µA**APO Timing:** Idle for 34 minutes**Dimension:** 161\*80\*50mm L\*W\*H (With Holster)**Weight:** Approx. 340 gm (With Holster)**Special Features:** AutoCheck™ V & Ω (model 255 & 257 only); Auto-ranging MAX/MIN Record (model 255 & 257 only); Crest mode (Peak Hold, model 255 & 257 only), Backlighted LCD (model 255 & 257 only); Auto-ranging Relative Zero mode; Display Hold; EF-Detection (NCV); Interface capabilities with PC computer; Input warning detection

**Accessories:** Test lead pair; batteries installed; user's manual; BKP60 banana plug type-K thermocouple (model 252, 255 & 257 only)

**Optional purchase accessories:** USB interface kit BRUA-20X; Magnetic hanger BMH-01; BKB32 banana plug to type-K socket plug adaptor

### Electrical Specification

Accuracy is given as +/- (% of reading digits + number of digits) or otherwise specified @ 23°C +/- 5°C and less than 75% R.H.

True RMS model BM257 ACV & ACA accuracies are specified from 5 % to 100 % of range or otherwise specified. Maximum Crest Factor <3:1 at full scale & <6:1 at half scale, and with frequency components fall within the meter specified frequency bandwidth for non-sinusoidal waveforms

#### AC Voltage

RANGE	Accuracy
<b>50Hz ~ 400Hz</b>	
60.00mV, 600.0mV	1.0% + 5d
6.000V, 60.00V, 600.0V, 1000V	

CMRR: >60dB @ DC to 60Hz, Rs=1kΩ

Input Impedance: 10MΩ, 50 pF nominal

#### AutoCheck™ ACV (model 255 & 257 only)

RANGE	Accuracy
<b>50Hz/60Hz</b>	
1.000V ~ 1000V	1.4% + 5d

AutoCheck™ Lo-Z ACV Threshold:

> 1V nominal

AutoCheck™ Lo-Z ACV Input Impedance:

Initially approx. 2.5kΩ, 120pF nominal; Impedance increases abruptly within a fraction of a second as display voltage is above 50V (typical). Ended up impedances vs display voltages typically are:

15kΩ @100V  
100kΩ @300V  
250kΩ @600V  
375kΩ @1000V

#### Ohm

RANGE	Accuracy
600.0Ω, 6.000KΩ, 60.00KΩ, 600.0KΩ	0.5%+4d
6.000MΩ	0.7%+4d
60.00MΩ	1.2%+4d

Open Circuit Voltage: 0.45VDC typical

#### DC Voltage

RANGE	Accuracy
60.00mV	0.4%+5d
600.0mV	0.2%+3d
6.000V, 60.00V, 600.0V, 1000V	

NMRR: > 60dB @ 50Hz/60Hz

CMRR: > 100dB @ DC, 50Hz/60Hz; Rs=1kΩ

Input Impedance: 10MΩ, 50 pF nominal

#### AutoCheck™ DCV (model 255 & 257 only)

RANGE	Accuracy
1.000V ~ 1000V	1.3% + 3d

AutoCheck™ Lo-Z DCV Threshold:

> +1.0VDC & < -1.0VDC nominal

AutoCheck™ Lo-Z DCV Input Impedance:

Initially approx. 2.5kΩ, 120pF nominal; Impedance increases abruptly within a fraction of a second as display voltage is above 50V (typical). Ended up impedances vs display voltages typically are:

15kΩ @100V  
100kΩ @300V  
250kΩ @600V  
375kΩ @1000V

#### AutoCheck™ Ohm (model 255 & 257 only)

RANGE <sup>1)</sup>	Accuracy
00.00Ω ~ 60.00MΩ	1.2% + 10d

Open Circuit Voltage: 0.45VDC typical

<sup>1)</sup>AutoCheck™ Ohm Threshold:

< 10.00MΩ nominal

**CREST Mode (model 255 & 257 only)**

Accuracy: Specified accuracy plus 150 digits for changes > 5ms in duration

**RECORD Mode (model 255 & 257 only)**

Accuracy: Specified accuracy plus 100 digits for changes > 100ms in duration

**Audible Continuity Tester**

Audible Threshold: Between 10Ω and 80Ω

Response time: 32ms

**Capacitance (model 252, 255 & 257 only)**

RANGE	Accuracy
60.00nF, 600.0nF	2.0%+5d
6.000μF, 60.00μF, 600.0μF	1.5%+5d
3000μF	2.0%+5d

Accuracies with film capacitor or better

**Diode Tester**

RANGE	Accuracy
1.000V	1.0% + 3d

Test Current: 0.56mA typically

Open Circuit Voltage: < 1.8VDC typically

**DC Current**

RANGE	Accuracy	Burden Voltage
600.0μA	0.5%+5d	0.10 mV/uA
6000μA	0.5%+3d	
60.00mA	0.5%+5d	1.7 mV/mA
600.0mA	0.5%+3d	
6.000A	1.2%+6d	0.03V/A
8.00A <sup>1)</sup>	1.8%+6d	

<sup>1)</sup> 8A continuous, >8A to 15A for 30 sec. max with 5 minutes cool down interval

**AC Current**

RANGE	Accuracy	Burden Voltage
<b>50Hz ~ 400Hz</b>		
600.0μA, 6000μA	1.0%+3d	0.10 mV/uA
60.00mA, 600.0mA		1.7 mV/mA
6.000A	1.2%+6d	0.03V/A
8.00A <sup>1)</sup>	1.8%+6d	

<sup>1)</sup> 8A continuous, >8A to 15A for 30 sec. max with 5 minutes cool down interval

**Temperature (model 252, 255 & 257 only)**

RANGE	Accuracy
-50 °C ~ 1000 °C	0.3% + 3d
-58 °F ~ 1832 °F	0.3% + 6d

K type thermocouple range & accuracy not included

**Logic Level Hz (mV Function)**

RANGE	Sensitivity (square wave)
5.00 Hz ~ 500.0 kHz	3 Vpeak
5.00 Hz ~ 1.000 MHz	5 Vpeak

Accuracy: 0.03%+2d

**Hz (Line) @ ACV, DCV, Current & AutoCheck™**

Function	Sensitivity (Sine RMS)	Range
6V	0.4V	10Hz - 10kHz
60V	4V	10Hz - 50kHz
600V	40V	10Hz - 50kHz
1000V	400V	45Hz - 1kHz
600μA	40μA	10Hz - 10kHz
6000μA	400μA	10Hz - 10kHz
60mA	4mA	10Hz - 10kHz
600mA	40mA	10Hz - 10kHz
6A	1A	10Hz - 1kHz
10A	6A	10Hz - 1kHz

Accuracy: 0.03%+3d

**Non-Contact EF-Detection**

Typical Voltage	Bar-Graph Indication
20V (tolerance: 10V ~ 36V)	-
55V (tolerance: 23V ~ 83V)	--
110V (tolerance: 59V ~ 165V)	---
220V (tolerance: 124V ~ 330V)	----
440V (tolerance: 250V & 1000V)	-----

Indication: Bar-graph segments & audible beep tones proportional to the field strength

Detection Frequency: 50/60Hz

Detection Antenna: Top-right end of the meter

Probe-Contact EF-Detection: For more precise indication of live wires, such as distinguishing between live and ground connections, use the Red (+) test probe for direct contact measurements

## LIMITED WARRANTY

BRYMEN warrants to the original product purchaser that each product it manufactures will be free from defects in material and workmanship under normal use and service within a period of one year from the date of purchase. BRYMEN's warranty does not apply to accessories, fuses, fusible resistors, spark gaps, batteries or any product which, in BRYMEN's opinion, has been misused, altered, neglected, or damaged by accident or abnormal conditions of operation or handling.

To obtain warranty service, contact your nearest BRYMEN authorized agent or send the product, with proof of purchase and description of the difficulty, postage and insurance prepaid, to BRYMEN TECHNOLOGY CORPORATION. BRYMEN assumes no risk for damage in transit. BRYMEN will, at its option, repair or replace the defective product free of charge. However, if BRYMEN determines that the failure was caused by misused, altered, neglected, or damaged by accident or abnormal conditions of operation or handling, you will be billed for the repair.

THIS WARRANTY IS EXCLUSIVE AND IS IN LIEU OF ALL OTHER WARRANTIES, EXPRESSED OR IMPLIED, INCLUDING BUT NOT LIMITED TO ANY IMPLIED WARRANTY OR MERCHANTABILITY OR FITNESS FOR A PARTICULAR PURPOSE OR USE. BRYMEN WILL NOT BE LIABLE FOR ANY SPECIAL, INDIRECT, INCIDENTAL OR CONSEQUENTIAL DAMAGES.



**BRYMEN TECHNOLOGY CORPORATION**

**TEL:+886 2 2226 3396**

**FAX:+886 2 2225 0025**

**<http://www.brymen.com>**



PRINTED ON RECYCLABLE PAPER, PLEASE RECYCLE

COPYRIGHT © MMIX BTC, ALL RIGHTS RESERVED

P/N: 7M1C-1011-A003

PRINTED IN TAIWAN