

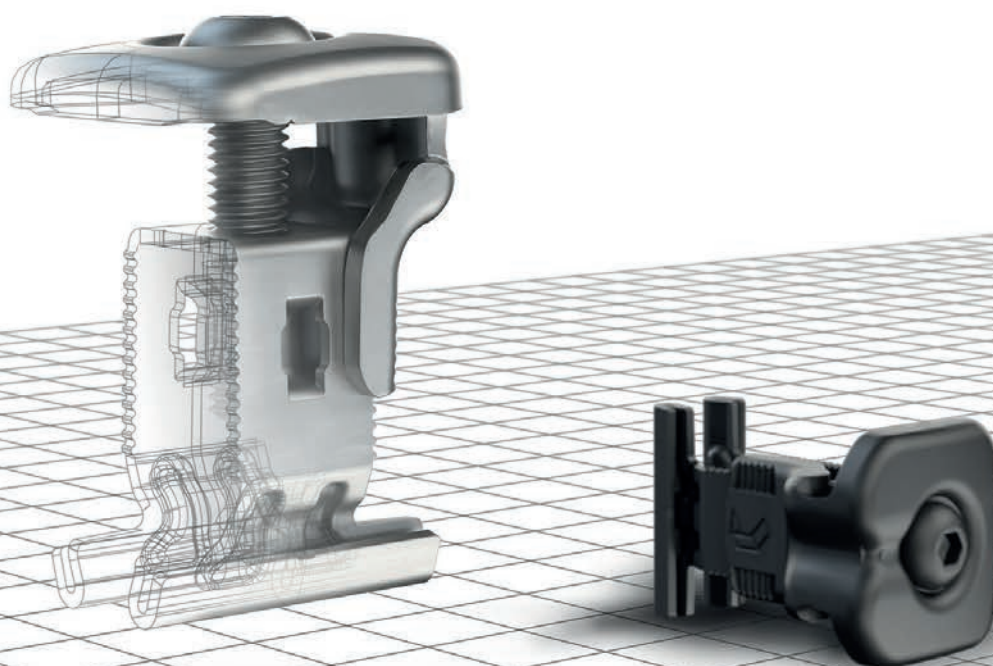

PRODUKTKATALOG
PRODUCT CATALOG



DE | Produktkatalog

Gültig ab 01.04.2019

Abbildungen und Texte dienen der Präsentation der Ware.

Änderungen und Irrtümer bleiben bis zur Abgabe der Bestellung durch den Kunden vorbehalten.

Preise ab Lager

GB | Product catalogue

Valid starting 01.04.2019

Illustrations and texts are used to present the product.

No liability is accepted for changes and errors made before the customer has placed an order.

Price ex works

FR | Catalogue de produits

Valable à partir du 01.04.2019

Les images et les textes servent à la présentation des produits.

Sous réserve de modifications et d'erreurs jusqu'à la passation de commande par le client.

Prix ex usine

IT | Catalogo prodotti

Valido dal 01.04.2019

Le figure e i testi sono indicativi.

Con riserva di modifica e di errore fino all'avvenuta ordinazione da parte del cliente.

Il prezzo franco fabbrica

ES | Catálogo de productos

Válido a partir del 01.04.2019

Las imágenes y textos están destinados a la presentación de la mercancía.

Nos reservamos el derecho a modificaciones y errores hasta la entrega del pedido por parte del cliente

El precio en fábrica



DE		Schrägdach	MS+ / MS+P / VS+
EN		Pitched-roof	MS+ / MS+P / VS+
FR		Toiture inclinée	MS+ / MS+P / VS+
IT		Tetti inclinati	MS+ / MS+P / VS+
ES		Tejado oblicuo	MS+ / MS+P / VS+



DE		Flachdach	FS10-EW / FS-S / CS+
EN		Flat-roof	FS10-EW / FS-S / CS+
FR		Toitures plates	FS10-EW / FS-S / CS+
IT		Tetti piani	FS10-EW / FS-S / CS+
ES		Tejado plano	FS10-EW / FS-S / CS+



DE		Indach	ISSE
EN		In-roof	ISSE
FR		Intégration	ISSE
IT		Integrazione	ISSE
ES		Integrado en cubierta	ISSE



DE		Zubehör
EN		Accessoires
FR		Accessoires
IT		Accessori
ES		Accesorio



DE		Muster
EN		Samples
FR		Echantillo
IT		Campioatura
ES		Muestra



DE		Aktualisierte Information
EN		Updated information
FR		Informations mises à jour
IT		Informazioni aggiornate
ES		Información actualizada



DE		Neues Produkt
EN		New product
FR		Nouveau produit
IT		Nuovo prodotto
ES		Producto nuevo

DEDICATED TO METAL









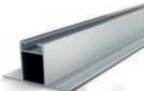

MS+/MS+ P

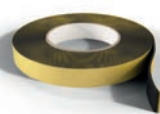

	D MetaSole+ Blechstärke Stahl 0,40-1,25 mm; Alu 0,50-1,50 mm	Item No. 420402
	UK MetaSole+ metal sheet thickness: steel 0.40-1.25mm; alu 0.50-1.50 mm	
	F MetaSole+ Epaisseur de tôle; acier 0,40 - 1,25 mm; alu 0,50 - 1,50 mm	
	I MetaSole+ Spessore lamiera; acciaio 0,40 - 1,25 mm; allu 0,50 - 1,50 mm	
	E MetaSole+ Grososres: acero 0,40 - 1,25 mm; alu 0,50 - 1,50 mm	
	D MetaSole+ Blechstärke: Stahl 0,75-1,00 mm	Item No. 420403
	UK MetaSole+ metal sheet thickness: steel 0.75-1.0 mm	
	F MetaSole+ Epaisseur de tôle: acier 0,75 - 1,00 mm	
	I MetaSole+ Spessore lamiera: acciaio 0,75 - 1,00 mm	
	E MetaSole+ Grososres: acero 0,75 - 1,00 mm	
	D MetaSole+ Blechstärke: Stahl 0,75 ETN Zertifikat	Item No. 420405
	UK MetaSole+ metal sheet thickness: steel 0.75 ETN Certification	
	F MetaSole+ Epaisseur de tôle: acier 0,75 mm; Certification ETN	
	I MetaSole+ Spessore lamiera: acciaio 0,75 mm; Certificato ETN	
	E MetaSole+ Grososres: acero 0,75 mm; certificación ETN	
	D MetaSole+ Klemmfuß mit Nieten ab 0,50 - 2,00 mm	Item No. 420406
	UK MetaSole+ foot with rivets from 0.50 - 2,00 mm	
	F MetaSole+ pied avec rivets 0,50 - 2,00 mm	
	I MetaSole+ piede con rivetti 0,50 - 2,00 mm	
	E MetaSole+ pie con remaches 0,50 - 2,00 mm	
	D MS+ Adapter Wellblech Radius 24	Item No. 420401
	UK MS+ Adapter corrugated sheet radius 24	
	F MS+ Adaptateur tôle ondulée rayon 24	
	I MS+ Adattatore lamiera ondulata raggio 24	
	E MS+ Adaptador chapa ondulada radio 24	
	D MS+ Portrait (Set)	Item No. 420420
	UK MS+ Portrait (Set)	
	F MS+ Portrait	
	I MS+ Verticale	
	E MS+ Formato alto	
	D MS+ Portrait Niete (Set)	Item No. 420422
	UK MS+ Portrait Rivet (Set)	
	F MS+ Portrait rivets (Set)	
	I MS+ Verticale rivetti (Set)	
	E MS+ Formato alto remanches (Set)	
	D MS+ Portrait 400 mm (Set)	Item No. 420421
	UK MS+ Portrait 400 mm (Set)	
	F MS+ Portrait 400 mm (Set)	
	I MS+ Verticale 400 mm (Set)	
	E MS+ Formato alto 400 mm (Set)	







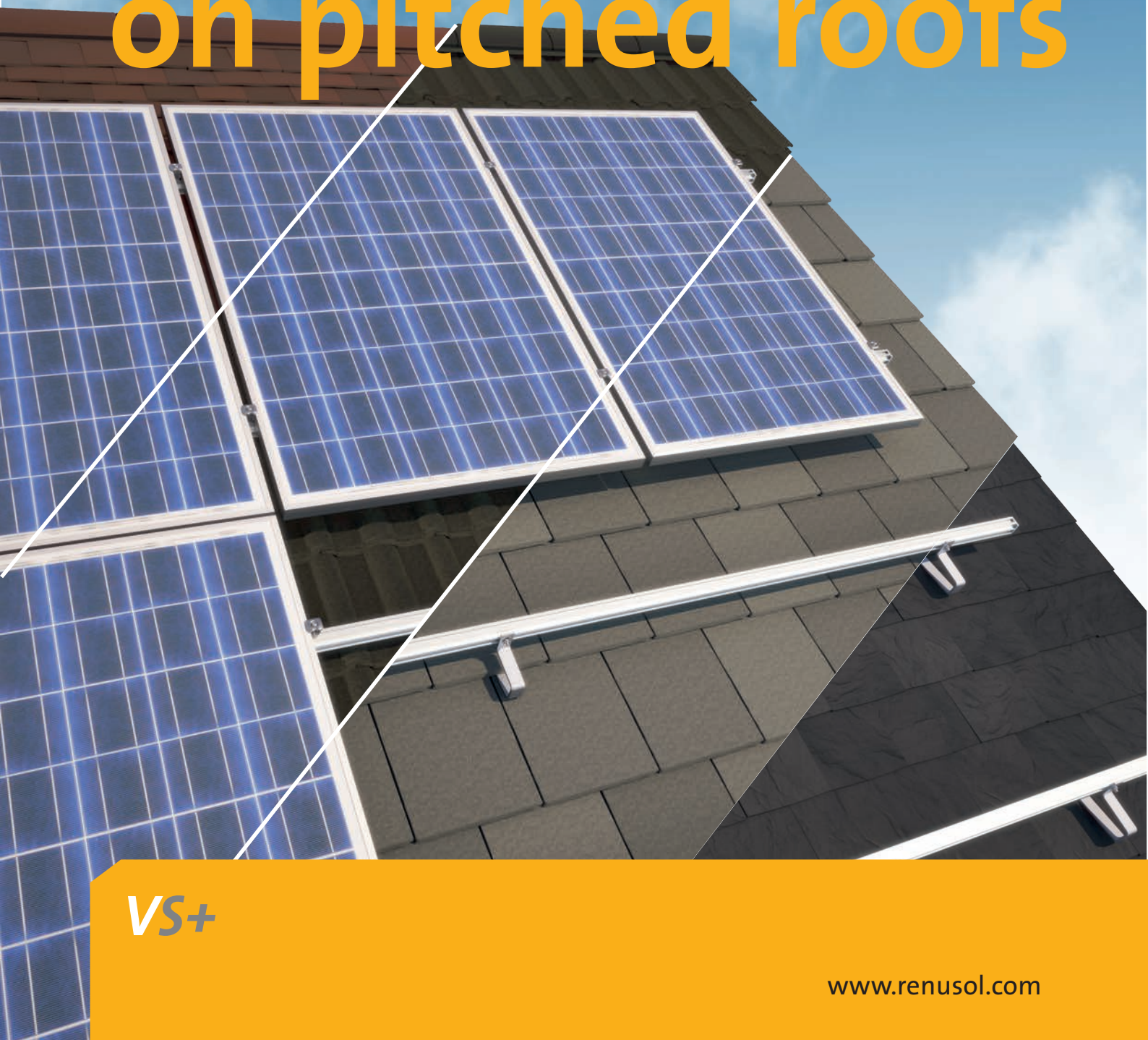



	D MS+ Portrait 3600mm ohne EPDM	Item No. 400405
	UK MS+ Portrait 3600 mm without EPDM	
	F MS+ Portrait 3600 mm sans EPDM	
	I MS+ Verticale 3600 mm senza EPDM	
	E MS+ Formato alto 3600 mm sin EPDM	
	D MS+ Hoch (Set)	Item No. 420423
	UK MS+ High (Set)	
	F MS+ Haut (Set)	
	I MS+ Elevati (Set)	
	E MS+ Elevado (Set)	
	D EPDM Rolle 5m für MS+ Portrait	Item No. 300224
	UK EPDM Roll 5m for MS+ Portrait	
	F Rouleau EPDM 5 m pour MS+ Portrait	
	I Rotolo EPDM 5 m per MS+ Verticale	
	E Rollo EPDM 5m para MS+ Formato alto	
	D Bohrschraube SW 8 6,0x25 E16	Item No. 400281
	UK Self drilling screw SW 8 6,0x25 E16	
	F Vis autoforeuse SW 8 6,0x25 E16	
	I Vite autoforante SW 8 6,0x25 E16	
	E Tornillo taladrador SW 8 6,0x25 E16	
	D Bohrschraube SFS-SDK2-S-377-6,0x35	Item No. 400047
	UK Self drilling screw SFS-SDK2-S-377- 6,0x35	
	F Vis autoforeuse SFS-SDK2-S-377- 6,0x35	
	I Vite autoforante SFS-SDK2-S-377- 6,0x35	
	E Tornillo taladrador SFS-SDK2-S-377- 6,0x35	
	D Bohrschraube Faynot P1 6,3 x 38	Item No. 900122
	UK Self drilling screw Faynot P1 6,3 x 38	
	F Vis autoforeuse Faynot P1 6,3 x 38	
	I Vite autoforante Faynot P1 6,3 x 38	
	E Tornillo taladrador Faynot P1 6,3 x 38	
	D Niete 6,4x14	Item No. 900270
	UK Rivets 6,4x14	
	F Rivets 6,4x14	
	I Rivetti 6,4x14	
	E Remaches 6,4x14	
	D MS+ Potentialausgleich Terragrif DUO	Item No. 900242
	UK MS+ Potential equalisation Terragrif DUO	
	F MS+ mise à la terre Terragrif DUO	
	I MS+ collegamento equipotenziale Terragrif DUO	
	E MS+ conexión equipotencial Terragrif DUO	

VS+ Allrounder on pitched roofs









VS+







	D Dachhaken Aluminium Standard (ohne Holzschraube)	Item No. 420151
	UK Roof hook aluminium (without wood screw)	
	F Crochet de toit aluminium (sans vis)	
	I Staffa alluminio (senza vite da legno)	
	E Gancho salvatejas Aluminio (sin tornillo de madera)	
	D VS Dachhaken Alu verstellbar 100mm (ohne Holzschraube)	Item No. 420161
	UK Roof hook aluminium adjustable 100 mm (without wood screw)	
	F Crochet de toit aluminium réglable 100 mm (sans vis)	
	I Staffa alluminio. regolabile 100 mm (senza vite da legno)	
	E Gancho salvatejas Aluminio ajustable 100 mm (sin tornillo de madera)	
	D Dachhaken Aluminium Beton Basic 90°	Item No. 920003
	UK Roof hook Alu Concrete Basic 90°	
	F Crochet de toit aluminium béton basic 90°	
	I Staffa alluminio Calcestruzzo 90°	
	E Gancho salvatejas Aluminio Hormigón 90°	
	D Dachhaken Edelstahl (ohne Holzschraube)	Item No. 420150
	UK Roof hook stainless steel (without wood screw)	
	F Crochet de toit acier inoxydable (sans vis)	
	I Staffa acciaio inossidabile (senza vite da legno)	
	E Gancho salvatejas acero inoxidable (sin tornillo de madera)	
	D Dachhaken Biber Standard (ohne Holzschraube)	Item No. 420153
	UK Roof hook for plain tiles Standard (without wood screw)	
	F Crochet de toit tuile plate standard (sans vis)	
	I Staffa Coda di castoro Standard (senza vite da legno)	
	E Gancho para tejas planas estándar (sin tornillo de madera)	
	D Dachhaken Biber 90° (ohne Holzschraube)	Item No. 420154
	UK Roof hook for plain tiles 90° (without wood screw)	
	F Crochet de toit tuile plate 90° (sans vis)	
	I Staffa Coda di castoro 90° (senza vite da legno)	
	E Gancho para tejas planas 90° (sin tornillo de madera)	
	D Dachhaken Schiefer (ohne Holzschraube)	Item No. 420155
	UK Roof hook for slate tiles (without wood screw)	
	F Crochet de toit ardoise (sans vis)	
	I Staffa Ardesia (senza vite da legno)	
	E Gancho para tejas de pizarra (sin tornillo de madera)	
	D Dachhaken Edelstahl Aufdachdämmung (ohne Holzschraube)	Item No. 420160
	UK Roof hook stainless steel on-roof insulation (without wood screw)	
	F Crochet en acier inox pour toiture avec isolation (sans vis)	
	I Staffa acciaio inossidabile per tetto con isolamento (senza vite)	
	E Gancho salvatejas para aislamiento sobre cubierta (sin tornillo)	



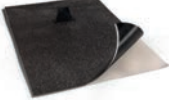





	D Dachhaken UK Dachpfanne (ohne Holzschraube)	Item No. 420180
	UK Roof hook UK Pantile (without wood screw)	
	F Crochet de toit UK tuile (sans vis)	
	I Staffa tegola UK, staffa (senza vite da legno)	
	E Gancho para cubierta de tejas UK (sin tornillo de madera)	
	D Dachhaken UK Biber/Schiefer (ohne Holzschraube)	Item No. 420181
	UK Roof hook UK Plain tiles/slates (without wood screw)	
	F Crochet de toit UK tuile plate/ardoise (sans vis)	
	I Staffa tegole piane/ardesia UK (senza vite da legno)	
	E Gancho para cubierta de pizarra UK (sin tornillo de madera)	
	D Dachhaken UK Flexibel (ohne Holzschraube)	Item No. 420182
	UK Roof hook UK Flexible (without wood screw)	
	F Crochet de toit UK flexible (sans vis)	
	I Staffa UK flessibile (senza vite da legno)	
	E Gancho para cubierta flexible UK (sin tornillo de madera)	
	D Dachhaken UK Flexibel 90° (ohne Holzschraube)	Item No. 420183
	UK Roof hook UK Flexible 90° (without wood screw)	
	F Crochet de toit UK flexible 90° (sans vis)	
	I Staffa UK flessibile 90° (senza vite da legno)	
	E Gancho para cubierta flexible UK 90° (sin tornillo de madera)	
	D Dachhaken ECO Basic (ohne Holzschraube)	Item No. 420165
	UK Roof hook ECO Basic (without wood screw)	
	F Crochet de toit ECO Basic (sans vis)	
	I Staffa Eco Basic (senza vite de lengo)	
	E Gancho para cubierta Eco Basic (sin tornillo de madera)	
	D Dachhaken Edelstahl Tegola Portoghese (ohne Holzschraube)	Item No. 420158
	UK Roof hook stainless steel Tegola Portoghese (without wood screw)	
	F Crochet de toit acier inoxydable Tegola Portoghese (sans vis)	
	I Staffa acciaio inossidabile Tegola Portoghese (senza vite da legno)	
	E Gancho salvatejas acero inoxidable Tegola Portoghese (sin tornillos)	
	D Multiträger Aluminium (Set)	Item No. 420308
	UK Aluminium multi support (set)	
	F Multi-support aluminium (set)	
	I Multiplo supporto alluminio (set)	
	E Soporte multiple aluminio (set)	



	D Dichtmanschette Multiträger	Item No. 400XXX
	UK Sealing-collar multi support	-340 rot/red/rouge/rosso/ rojo
	F Manchette d'étanchéité multi-support	-341 anthrazit/anthracite/ antracite/antracita
	I Guarnizione multiplo supporto	-342 braun/brown/marron/ marrone/marrón
	E Guarnición de obturación soporte multiple	
	D Dichtmanschette Biber/Schiefer	Item No. 400XXX
	UK Sealing-collar slate/plain tiles	-315 schwarz/black/noir/ nero/negro
	F Manchette d'étanchéité pour tuiles plates/ardoise	-316 rot/red/rouge/rosso/ rojo
	I Guarnizione per tegole piane/in ardesia	-317 anthrazit/anthracite/ antracite/antracita
	E Guarnición de obturación para tejas planas/pizarra	
	D Dichtmanschette Ziegeldach	Item No. 400XXX
	UK Sealing-collar for tiled roof	-318 schwarz/black/noir/ nero/negro
	F Manchette d'étanchéité pour toitures en tuiles	-319 rot/red/rouge/rosso/ rojo
	I Guarnizione per tetti di tegole	-320 anthrazit/anthracite/ antracite/antracita
	E Guarnición de obturación para tejados de tejas	-321 braun/brown/marron/ marrone/marrón
	D Distanzplatte 2 mm	Item No. 400350
	UK 2-mm spacer plate	
	F Plaque d'écartement 2 mm	
	I Piastra distanziale 2mm	
	E Placa calzadora 2 mm	
	D Distanzplatte 5 mm	Item No. 400351
	UK 5-mm spacer plate	
	F Plaque d'écartement 5 mm	
	I Piastra distanziale 5mm	
	E Placa calzadora 5 mm	



	D Holzbohrschraube Linsenkopf 6 x 80/74	Item No. 900305
	UK Wood screw pan head 6 x 80/74	
	F Vis à bois tête lenticulaire 6 x 80/74	
	I Vite da legno testa tonda 6 x 80/74	
	E Tornillo madera con cabeza convexa 6 x 80/74	
	D Holzschraube Senkkopf für Schieferdachhaken 6 x 80	Item No. 900013
	UK Wood screw countersunk 6 x 80	
	F Vis à bois tête fraisée 6 x 80 pour ardoises	
	I Vite da legno testa piana per ardesia 6 x 80	
	E Tornillo madera para teja planas cabeza avellanada 6 x 80	
	D Holzschraube Tellerkopf 8,0 x 100	Item No. 900129
	UK Dish-shaped head wood screw with cutting edge 8 x 100	
	F vis à bois à tête plate aver enoche 8 x 100	
	I Vite a testa svasata 8 x 100 per pannello truciolare	
	E Tornillo para madera con cabeza plana y ranura de incision 8 x 100	
	D Tellerkopfschraube A2 6,0x120 / TX 30	Item No. 900127
	UK Dish-shaped wood screw A2 6,0x120 / TX 30	
	F Vis à bois à tête plate aver enoche A2 6,0x120 / TX30	
	I Vite a testa svasata 6x120/TX30 per pannello truciolare	
	E Tornillo para madera con cabeza plana y ranura de incision 6,0x120/TX30	
	D Holzschraube Tellerkopf 6 x 160	Item No. 900145
	UK Dish-shaped head wood screw with cutting edge 6 x 160	
	F vis à bois à tête plate aver enoche 6 x 160	
	I Vite a testa svasata 6 x 160 per pannello truciolare	
	E Tornillo para madera con cabeza plana y ranura de incision 6 x 160	
	D Holzschraube Linsenkopf 5 x 30	Item No. 900050
	UK Wood screw mushroom head 5 x 30	
	F Vis à bois tête lenticulaire 5 x 30	
	I Vite da legno testa tonda 5 x 30	
	E Tornillo madera con cabeza convexa 5 x 30	



1x **D** Dachhaken
UK Roof hooks
F Crochet de toit
I Staffa
E Gancho de tejado

+ **n**

D Holzschraube
UK Wood screw
F Vis a bois
I Vite da legno
E Tornillo de madera

	900305	900013	900129	900127	900145	900050
420151	3x	–	–	2x	2x	–
420161	3x	–	–	2x	2x	–
920003	–	–	2x	–	–	–
420150	3x	–	–	2x	2x	–
420153	2x	–	–	2x	2x	–
420154	2x	–	–	2x	2x	–
420155	–	2x	–	–	–	–
420156	–	2x	–	–	–	–
420160	–	–	–	–	–	3x
420180	2x	–	–	–	–	–
420181	2x	–	–	–	–	–
420182	2x	–	–	–	–	–
420183	2x	–	–	–	–	–
420158	3x	–	–	2x	2x	–



D Solarbefestiger für Stahlunterkonstruktion

UK Solar Fastener for steel substructure

F Élément de fixation solaire pour structures porteuses en acier

I Fissaggio solare per sottostruttura in acciaio

E Fijador solar para subconstrucción de acero

D Solarbefestiger für Holzunterkonstruktion

UK Solar fastener for wooden substructure

F Élément de fixation solaire pour structures porteuses en bois

I Fissaggio solare per sottostruttura in legno

E Fijador solar para subconstrucción de madera

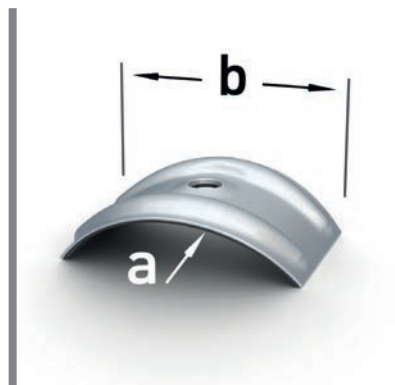
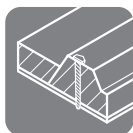
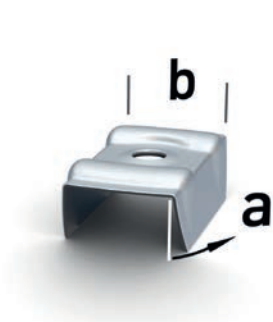
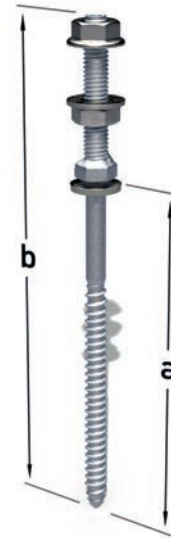
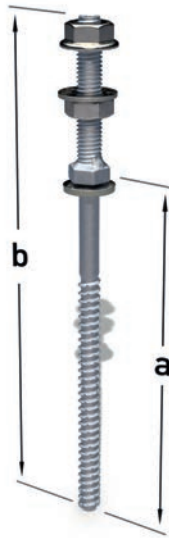



D Stockschraube

UK Hanger bolt

F Vis double filetage

I Vite prigioniera

E Tornillo espárrago de doble rosca

	a (mm)	Item No.
M10 x 200	200	860006
M12 x 250	250	860007
M12 x 300	300	860017
M12 x 350	350	920136
M12 x 400	400	920137



D Stockschraube (Anbindung versetzt)

UK Hanger bolt (offset connection)

F Vis double filetage (fixation décentrée)

I Vite prigioniera (fissaggio decentrato)

E Tornillo espárrago de doble rosca (orificio dec.)

	a (mm)	Item No.
M10 x 160	160	920159
M10 x 200	200	920008
M12 x 250	250	920002



D Solarbefestiger für Stahlunterkonstruktion

UK Solar Fastener for steel substructure

F Élément de fixation solaire pour structures porteuses en acier

I Fissaggio solare per sottostruttura in acciaio

E Fijador solar para subconstrucción de acero

	a (mm)	b (mm)	Item No.
80/50	80	136	900181
100/50	100	156	900182
125/50	125	181	900183
150/50	150	206	900184
160/50	160	216	900185
200/50	200	256	900186



D Solarbefestiger für Holzunterkonstruktion

UK Solar fastener for wooden substructure

F Élément de fixation solaire pour structures porteuses en bois

I Fissaggio solare per sottostruttura in legno

E Fijador solar para subconstrucción de madera

	a (mm)	b (mm)	Item No.
80/50	80	136	900187
100/50	100	156	900188
130/50	130	186	900189
150/50	150	206	900190
180/50	180	236	900191
200/50	200	256	900192



- D** Kalotte für Trapezblech
- UK** Storm washer for trapezoidal sheet
- F** Calotte pour toitures en tôles à ondes trapézoïdales
- I** Calotta per tetti a lamiera grecata
- E** Calota para tejados de chapa trapezoidal

	a (mm)	b (mm)	Item No.
W15/20	15°	20	900205
W15/25	15°	25	900206
W17/40	17°	40	900207
W22/57	22°	57	900208
W24/30	24°	30	900209
W27/25	27°	25	900210
W30/23	30°	23	900211
W32/54	32°	54	900212

	a (mm)	b (mm)	Item No.
W33/37	33°	37	900213
W35/20	35°	20	900214
W35/28	35°	28	900215
W36/40	36°	40	900216
W38/30	38°	30	900217
W40/26	40°	26	900218
W23/34	23°	34	900219

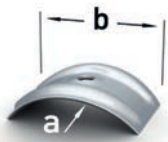

- D** Kalotte für Wellblech
- UK** Storm washer for corrugated sheet
- F** Calotte pour profilés ondulés
- I** Calotta per profilati ondulati
- E** Calota para perfiles ondulados

	a (mm)	b (mm)	Item No.
R24/37	24	37	900220
R32/51	32	51	900221
R48/62	48	62	900222



- D** Schirmdichtung
- UK** EPDM gasket
- F** Joint
- I** Guarnizione
- E** Junta de apantallamiento

	a (mm)	b (mm)	Item No.
EPDM	8,4	25	900193



- D** Solarbefestigerblech für Bitumenschindel 246x205 mm
- UK** Solar fastener flashing for bitumen shingles 246x205 mm
- F** Tôle de élément de fixation solaire pour bardeaux bitumeux 246x205
- I** Latta per fissaggio solare per tegola bituminosa 246x205
- E** Chapa para fijador solar en placas bituminosas 246x205

Item No.
900203

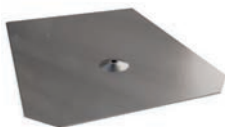







- D** Solarbefestigerblech für Bitumenschindel 380x280 mm
- UK** Solar fastener flashing for bitumen shingles 380x280 mm
- F** Tôle de élément de fixation solaire pour bardeaux bitumeux 380x280
- I** Latta per fissaggio solare per tegola bituminosa 380x280
- E** Chapa para fijador solar en placas bituminosas 380x280

Item No.
900204









	D TS+ Schere (SET)	Item No. 420550
	UK TS+ V-frame (SET)	
	F TS+ Support en ciseaux (SET)	
	I TS+ Staffa a forbice (SET)	
	E TS+ Perfil articulado (SET)	
	D TS+ Stütze 10°	Item No. 400552
	UK TS+ Support 10°	
	F TS+ Colonne 10°	
	I TS+ Puntello 10°	
	E TS+ Soporte 10°	
	D TS+ Stütze 15°	Item No. 400553
	UK TS+ Support 15°	
	F TS+ Colonne 15°	
	I TS+ Puntello 15°	
	E TS+ Soporte 15°	
	D TS+ Stütze 20°	Item No. 400554
	UK TS+ Support 20°	
	F TS+ Colonne 20°	
	I TS+ Puntello 20°	
	E TS+ Soporte 20°	
	D TS+ Stütze 25°	Item No. 400555
	UK TS+ Support 25°	
	F TS+ Colonne 25°	
	I TS+ Puntello 25°	
	E TS+ Soporte 25°	
	D TS+ Stütze 30°	Item No. 400556
	UK TS+ Support 30°	
	F TS+ Colonne 30°	
	I TS+ Puntello 30°	
	E TS+ Soporte 30°	
	D TS+ Stütze 35°	Item No. 400557
	UK TS+ Support 35°	
	F TS+ Colonne 35°	
	I TS+ Puntello 35°	
	E TS+ Soporte 35°	
	D TS+ Dreieck 10° montiert	Item No. 410552
	UK TS+ Triangle 10° assembled	
	F TS+ 10° (monté)	
	I TS+ 10° (montata)	
	E TS+ 10° (montado)	



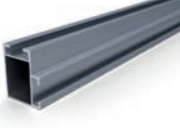

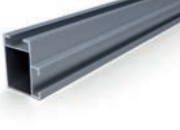
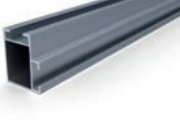



	D TS+ Dreieck 15° montiert	Item No. 410553
	UK TS+ Triangle 15° assembled	
	F TS+ 15° (monté)	
	I TS+ 15° (montata)	
	E TS+ 15° (montado)	
	D TS+ Dreieck 20° montiert	Item No. 410554
	UK TS+ Triangle 20° assembled	
	F TS+ 20° (monté)	
	I TS+ 20° (montata)	
	E TS+ 20° (montado)	
	D TS+ Dreieck 25° montiert	Item No. 410555
	UK TS+ Triangle 25° assembled	
	F TS+ 25° (monté)	
	I TS+ 25° (montata)	
	E TS+ 25° (montado)	
	D TS+ Dreieck 30° montiert	Item No. 410556
	UK TS+ Triangle 30° assembled	
	F TS+ 30° (monté)	
	I TS+ 30° (montata)	
	E TS+ 30° (montado)	
	D TS+ Dreieck 35° montiert	Item No. 410557
	UK TS+ Triangle 35° assembled	
	F TS+ 35° (monté)	
	I TS+ 35° (montata)	
	E TS+ 35° (montado)	
	D TS+ L-Profil Querverstrebung (SET)	Item No. 420600
	UK TS+ L-Profile cross striving profile (SET)	
	F TS+ Renfort L-profilé croisé complet(SET)	
	I TS+ L-Profil controvento completi (SET)	
	E TS+ L-profil esfuerzo (SET)	



	D VS+ Montageschiene 41 x 35 x 2100 mm	Item No. 400515
	UK VS+ Mounting rail 41 x 35 x 2100 mm	
	F VS+ Profilé de montage 41 x 35 x 2100 mm	
	I VS+ Guida alluminio 41 x 35 x 2100 mm	
	E VS+ Perfil base 41 x 35 x 2100 mm	
	D VS+ Montageschiene 41 x 35 x 3200 mm	Item No. 400511
	UK VS+ Mounting rail 41 x 35 x 3200 mm	
	F VS+ Profilé de montage 41 x 35 x 3200 mm	
	I VS+ Guida alluminio 41 x 35 x 3200 mm	
	E VS+ Perfil base 41 x 35 x 3200 mm	
	D VS+ Montageschiene 41 x 35 x 3200 mm (schwarz)	Item No. 400511-B
	UK VS+ Mounting rail 41 x 35 x 3200 mm (black)	
	F VS+ Profilé de montage 41 x 35 x 3200 mm (noir)	
	I VS+ Guida alluminio 41 x 35 x 3200 mm (nero)	
	E VS+ Perfil base 41 x 35 x 3200 mm (negro)	
	D VS+ Montageschiene 41 x 35 x 4200 mm	Item No. 400512
	UK VS+ Mounting rail 41 x 35 x 4200 mm	
	F VS+ Profilé de montage 41 x 35 x 4200 mm	
	I VS+ Guida alluminio 41 x 35 x 4200 mm	
	E VS+ Perfil base 41 x 35 x 4200 mm	
	D VS+ Montageschiene 41 x 35 x 4200 mm (schwarz)	Item No. 400512-B
	UK VS+ Mounting rail 41 x 35 x 4200 mm (black)	
	F VS+ Profilé de montage 41 x 35 x 4200 mm (noir)	
	I VS+ Guida alluminio 41 x 35 x 4200 mm (nero)	
	E VS+ Perfil base 41 x 35 x 4200 mm (negro)	
	D VS+ Montageschiene 41 x 35 x 6200 mm	Item No. 400513
	UK VS+ Mounting rail 41 x 35 x 6200 mm	
	F VS+ Profilé de montage 41 x 35 x 6200 mm	
	I VS+ Guida alluminio 41 x 35 x 6200 mm	
	E VS+ Perfil base 41 x 35 x 6200 mm	
	D VS+ Montageschiene 41 x 35 mm Zuschnitt/m	Item No. 400519
	UK VS+ Mounting rail 41 x 35 custom cut /m	
	F VS+ Profilé de montage 41 x 35 coupe /m	
	I VS+ Guida alluminio 41 x 35 su misura /m	
	E VS+ Perfil base 41 x 35 a medida /m	
	D VS+ Montageschiene 41 x 35 mm Zuschnitt/m (schwarz)	Item No. 400519-B
	UK VS+ Mounting rail 41 x 35 custom cut /m (black)	
	F VS+ Profilé de montage 41 x 35 coupe /m (noir)	
	I VS+ Guida alluminio 41 x 35 su misura /m (nero)	
	E VS+ Perfil base 41 x 35 a medida /m (negro)	

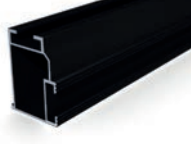

	D	VS+ Montageschiene 50 x 37 x 2100 mm	Item No.	400510
	UK	VS+ Mounting rail 50 x 37 x 2100 mm		
	F	VS+ Profilé de montage 50 x 37 x 2100 mm		
	I	VS+ Guida alluminio 50 x 37 x 2100 mm		
	E	VS+ Perfil base 50 x 37 x 2100 mm		
	D	VS+ Montageschiene 50 x 37 x 3200 mm	Item No.	400502
	UK	VS+ Mounting rail 50 x 37 x 3200 mm		
	F	VS+ Profilé de montage 50 x 37 x 3200 mm		
	I	VS+ Guida alluminio 50 x 37 x 3200 mm		
	E	VS+ Perfil base 50 x 37 x 3200 mm		
	D	VS+ Montageschiene 50 x 37 x 3200 mm (schwarz)	Item No.	400502-B
	UK	VS+ Mounting rail 50 x 37 x 3200 mm (black)		
	F	VS+ Profilé de montage 50 x 37 x 3200 mm (noir)		
	I	VS+ Guida alluminio 50 x 37 x 3200 mm (nero)		
	E	VS+ Perfil base 50 x 37 x 3200 mm (negro)		
	D	VS+ Montageschiene 50 x 37 x 4200 mm	Item No.	400505
	UK	VS+ Mounting rail 50 x 37 x 4200 mm		
	F	VS+ Profilé de montage 50 x 37 x 4200 mm		
	I	VS+ Guida alluminio 50 x 37 x 4200 mm		
	E	VS+ Perfil base 50 x 37 x 4200 mm		
	D	VS+ Montageschiene 50 x 37 x 4200 mm (schwarz)	Item No.	400505-B
	UK	VS+ Mounting rail 50 x 37 x 4200 mm (black)		
	F	VS+ Profilé de montage 50 x 37 x 4200 mm (noir)		
	I	VS+ Guida alluminio 50 x 37 x 4200 mm (nero)		
	E	VS+ Perfil base 50 x 37 x 4200 mm (negro)		
	D	VS+ Montageschiene 50 x 37 x 6200 mm	Item No.	400506
	UK	VS+ Mounting rail 50 x 37 x 6200 mm		
	F	VS+ Profilé de montage 50 x 37 x 6200 mm		
	I	VS+ Guida alluminio 50 x 37 x 6200 mm		
	E	VS+ Perfil base 50 x 37 x 6200 mm		
	D	VS+ Montageschiene 50 x 37 mm Zuschnitt/m	Item No.	400509
	UK	VS+ Mounting rail 50 x 37 custom cut /m		
	F	VS+ Profilé de montage 50 x 37 coupe /m		
	I	VS+ Guida alluminio 50 x 37 su misura /m		
	E	VS+ Perfil base 50 x 37 a medida /m		
	D	VS+ Montageschiene 50 x 37 mm Zuschnitt/m (schwarz)	Item No.	400509-B
	UK	VS+ Mounting rail 50 x 37 custom cut /m (black)		
	F	VS+ Profilé de montage 50 x 37 coupe /m (noir)		
	I	VS+ Guida alluminio 50 x 37 su misura /m (nero)		
	E	VS+ Perfil base 50 x 37 a medida /m (negro)		



	D VS+ Schienenverbinder 41 x 35	Item No. 400531
	UK VS+ Rail connector 41 x 35	
	F VS+ Raccord de profilés de montage 41 x 35	
	I VS+ Connettore per guida 41 x 35	
	E VS+ Carril de unión para perfil 41 x 35	
	D VS+ Schienenverbinder 50 x 37	Item No. 400532
	UK VS+ Rail connector 50 x 37	
	F VS+ Raccord de profilés de montage 50 x 37	
	I VS+ Connettore per guida 50 x 37	
	E VS+ Carril de unión para perfil 50 x 37	
	D Abdeckkappe VS+ Montageschiene 50x37 (grau) Rechts/Links	Item No. 920044
	UK Cap VS+ Mounting rail 50x37 (grey) Right/Left	
	F Capuchon VS+ Profilé de montage 50x37(gris) D/G	
	I Tappo di copertura VS+ Guida alluminio 50x37 (grigio) Destro/Sinistro	
	E Tapa de cobertura VS+ Perfil base 50x37 (gris) Der/Izq	
	D Abdeckkappe VS+ Montageschiene 50x37 (schwarz) Rechts/Links	Item No. 920043
	UK Cap VS+ Mounting rail 50x37 (black) Right/Left	
	F Capuchon VS+ Profilé de montage 50x37 (noir) D/G	
	I Tappo di copertura VS+ Guida alluminio 50x37 (nero) Destro/Sinistro	
	E Tapa de cobertura VS+ Perfil base 50x37 (negro) Der/Izq	
	D Abdeckkappe VS+ Montageschiene 41x35 (grau)	Item No. 900246
	UK Cap VS+ Mounting rail 41x35 (grey)	
	F Capuchon VS+ Profilé de montage 41x35 (gris)	
	I Tappo di copertura VS+ Guida alluminio 41x35 (grigio)	
	E Tapa de cobertura VS+ Perfil base 41x35 (gris)	
	D Abdeckkappe VS+ Montageschiene 41x35 (schwarz)	Item No. 900245
	UK Cap VS+ Mounting rail 41x35 (black)	
	F Capuchon VS+ Profilé de montage 41x35 (noir)	
	I Tappo di copertura VS+ Guida alluminio 41x35 (nero)	
	E Tapa de cobertura VS+ Perfil base 41x35 (negro)	
	D Kreuzschienenverbinder+	Item No. 420083
	UK Cross rail connector+	
	F Raccord perpendiculaire+	
	I Connettore perpendicolare+	
	E Carril de unión perpendicular+	
	D Kreuzschienenverbinder+ (schwarz)	Item No. 420083-BE
	UK Cross rail connector+ (black)	
	F Raccord perpendiculaire+ (noir)	
	I Connettore perpendicolare+ (nero)	
	E Carril de unión perpendicular+ (negro)	

Aim for the sun!

FS10-S



FS18-S





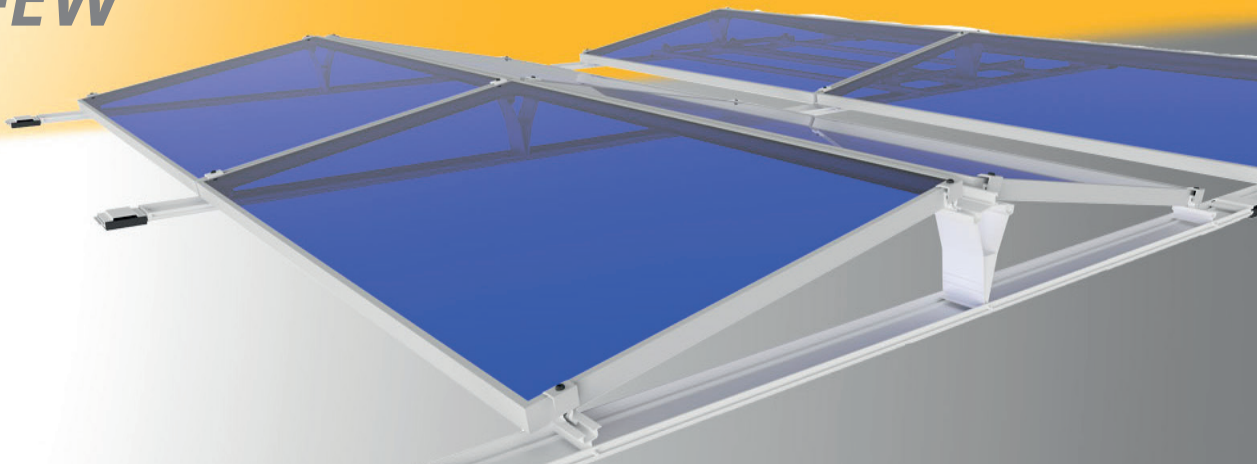

FS10-EW



FS 10/18-S | FS 10-EW

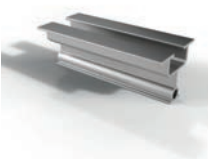

	D Bodenschiene FS10-S 1389 mm	Item No. 500400
	UK Base rail FS10-S 1389 mm	
	F Rail de montage FS10-S 1389 mm	
	I Guida di supporto FS10-S 1389 mm	
	E Perfil de montaje FS10-S 1389 mm	
	D Bodenschiene FS18-S 1739 mm	Item No. 500401
	UK Base rail FS18-S 1739 mm	
	F Rail de montage FS18-S 1739 mm	
	I Guida di supporto FS18-S 1739 mm	
	E Perfil de montaje FS18-S 1739 mm	
	D Bodenschiene FS10-S 1639 mm	Item No. 500402
	UK Base rail FS10-S 1639 mm	
	F Rail de montage FS10-S 1639 mm	
	I Guida di supporto FS10-S 1639 mm	
	E Perfil de montaje FS10-S 1639 mm	
	D Bodenschiene FS18-S 1989 mm	Item No. 500403
	UK Base rail FS18-S 1989 mm	
	F Rail de montage FS18-S 1989 mm	
	I Guida di supporto FS18-S 1989 mm	
	E Perfil de montaje FS18-S 1989 mm	
	D Bodenschiene FS10-EW 2260 mm	Item No. 500500
	UK FS10-EW Base rail FS10-EW 2260 mm	
	F FS10-EW Rail de montage FS10-EW 2260 mm	
	I FS10-EW Guida di supporto FS10-EW 2260 mm	
	E FS10-EW Perfil de montaje FS10-EW 2260 mm	
	D Bautenschutzmatte 110x95x20mm standard	Item No. 500410
	UK Roof protection pad 110x95x20mm standard	
	F Tapis de protection 110x95x20 mm standard	
	I Stuoia di protezione 110x95x20mm standard	
	E Protección para la cubierta 110x95x20mm estándar	
	D Bautenschutzmatte 110x95x20mm alu kaschiert	Item No. 500411
	UK Roof protection pad 110x95x20mm alu coated	
	F Tapis de protection 110x95x20 mm revêtement alu	
	I Stuoia di protezione 110x95x20mm effetto alluminio	
	E Protección para la cubierta 110x95x20mm forrada de aluminio	
	D Bautenschutzmatte 1000x100x11 mm für Bodenschiene	Item No. 500412
	UK Roof protection pad 1000x100x11 mm for base rail	
	F Tapis de protection 1000x100x11 mm pour rail de montage	
	I Stuoia di protezione 1000x100x11 mm par guida di supporto	
	E Protección para la cubierta 1000x100x11 mm para perfil de montaje	

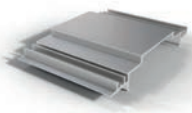
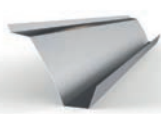
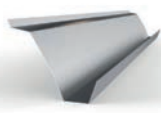
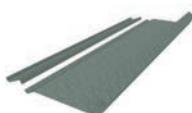





	D Auflager Traufe	Item No. 500420
	UK Eave support	
	F Support de gouttière	
	I Supporto grondaia	
	E Soporte canalón	
	D Auflager First 10°	Item No. 500421
	UK Ridge support 10°	
	F Support de faîte 10°	
	I Supporto colmo 10°	
	E Soporte cumbrera 10°	
	D Auflager First 18° (montiert)	Item No. 510422
	UK Ridge support 18° (assembled)	
	F Support de faîte 18° (monté)	
	I Supporto colmo 18° (montata)	
	E Soporte cumbrera 18° (montado)	
	D FS10-EW Auflager First 10°	Item No. 500520
	UK FS10-EW Ridge support 10°	
	F FS10-EW Support de faîte 10°	
	I FS10-EW Supporto colmo 10°	
	E FS10-EW Soporte cumbrera 10°	
	D Bodenschienenverbinder	Item No. 500404
	UK Base rail connector	
	F Raccord pour rails	
	I Raccordo per guide	
	E Unión para perfiles de montaje	
	D Streamliner FS10-S	Item No. 500430
	UK Streamliner FS10-S	
	F Streamliner FS10-S	
	I Streamliner FS10-S	
	E Streamliner FS10-S	
	D Streamliner FS10-S 2050mm	Item No. 500433
	UK Streamliner FS10-S 2050mm	
	F Streamliner FS10-S 2050mm	
	I Streamliner FS10-S 2050mm	
	E Streamliner FS10-S 2050mm	
	D Streamliner FS18-S (Set)	Item No. 520431
	UK Streamliner FS18-S(Set)	
	F Streamliner FS18-S(Set)	
	I Streamliner FS18-S(Set)	
	E Streamliner FS18-S(Set)	



Flachdach / Flat roof







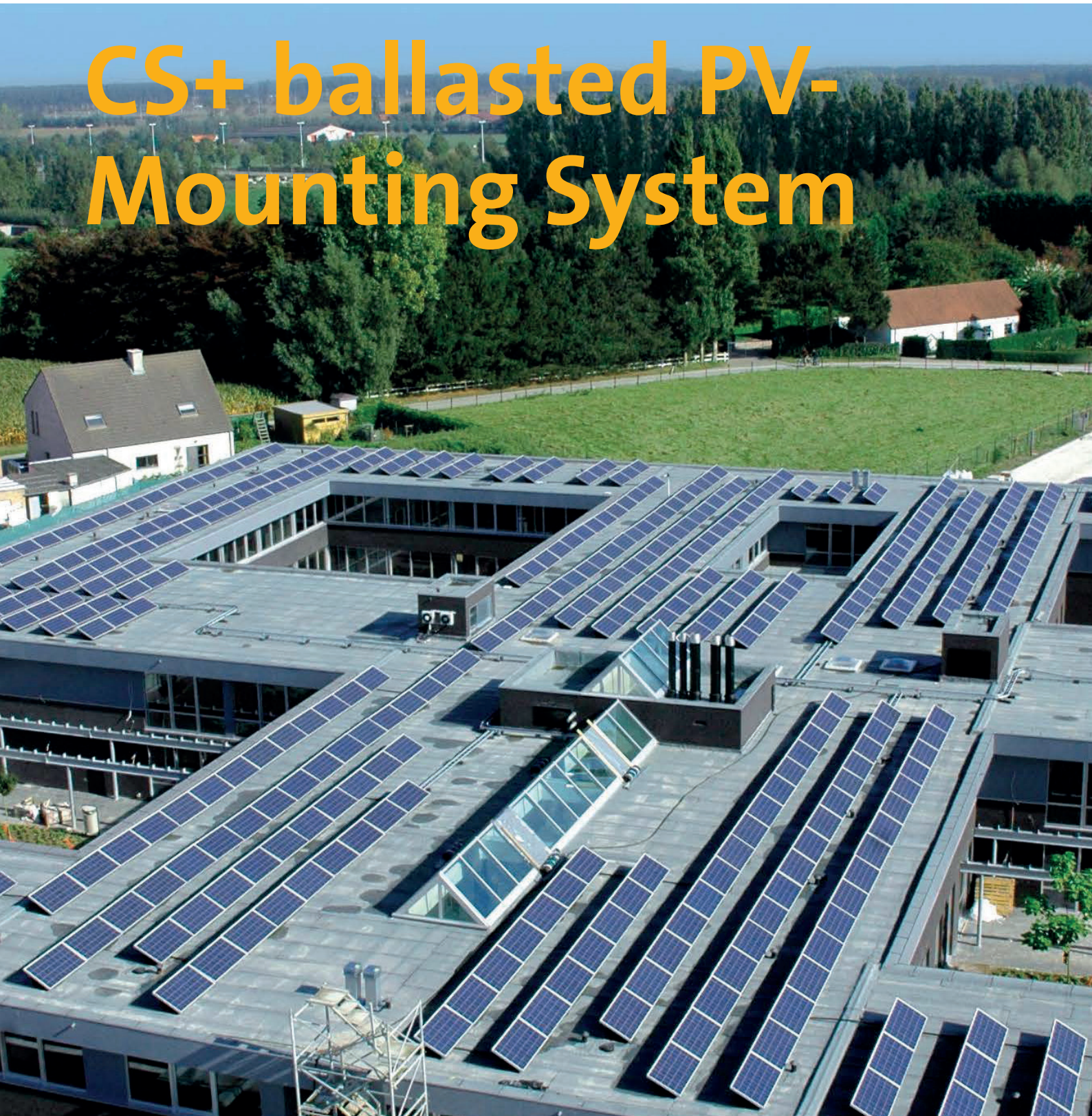

	D Streamliner FS18-S 2000mm (Set)	Item No. 520432	
	UK Streamliner FS18-S 2000mm (Set)		
	F Streamliner FS18-S 2000mm (Set)		
	I Streamliner FS18-S 2000mm (Set)		
	E Streamliner FS18-S 2000mm (Set)		
	D Potentialausgleichshaube FS-S	Item No. 900249	
	UK Potential equalisation cap FS-S		
	F Capot de mise à la terre FS-S		
	I Staffa collegamento equipotenziale FS-S		
	E Sujeción para cable de tierra FS-S		
	D Falzklemme mit geradem Anschluss aus nichtrostendem Stahl	Item No. 900251	
	UK Saddle clamp straight attachment stainless steel		
	F Pince/attache verticale en acier inox		
	I Morsetti a sella con attacco verticale in acciaio inossidabile		
	E Fijador en pliegue con conexión recto de acero inoxidable		
	D Steckbolzen 6x110	Item No. 900314	
	UK Socket Bolt 6x110		
	F Axe Débrochable 6x110		
	I Vite cilindrica a scatto rapido 6x110		
	E Perno Enchufable 6x110		
	D Bohrschraube 4,8x19 A2	Item No. 900229	
	UK Self Drilling Screw 4,8x19 A2		
	F Vis autoforeuse 4,8x19 A2		
	I Vite autoperforante 4,8x19 A2		
	E Tornillo autoperforante 4,8x19 A2		
	D Bohrschraube 5,5x35 A2	Item No. 900234	
	UK Self Drilling Screw 5,5x35 A2		
	F Vis autoforeuse 5,5x35 A2		
	I Vite autoperforante 5,5x35 A2		
	E Tornillo autoperforante 5,5x35 A2		
	D U-Scheibe DIN9021-6,4-A2	Item No. 900028	
	UK Plain washer DIN9021-6,4-A2		
	F Rondelle DIN9021-6,4-A2		
	I Rondella DIN9021-6,4-A2		
	E Arandela DIN9021-6,4-A2		

	D Falzklemme mit gewinkelt Anschluss aus Aluminium	Item No. 900252
	UK Saddle clamp with angle attachment aluminum	
	F Pince/attache angulaire en aluminium	
	I Morsetti a sella con attacco angolare in alluminio	
	E Fijador en pligüe von conexión en ángulo de aluminio	
	D Fangspitze Aluminium 1500 mm; Durchmesser 10 mm	Item No. 900253
	UK Air-termination Rod Aluminum 1500 mm; diameter 10 mm	
	F Paratonnerre aluminium 1500 mm ; diamètre 10 mm	
	I Asta di captazione in alluminio 1500 mm; diametro 10 mm	
	E Puntas captadoras de aluminio 1500 mm; diámetro 10 mm	
	D Ballastset FS10-EW (Set)	Item No. 520500
	UK Ballast set FS10-EW (Set)	
	F Set de remplissage FS10-EW (Set)	
	I Set di ballast per FS10-EW (Set)	
	E Juego por lastre para FS10-EW (Set)	
	D Ballastset FS10/18-S (Set)	Item No. 520510
	UK Ballast set FS10/18-S (Set)	
	F Set de remplissage FS10/18-S (Set)	
	I Set di ballast per FS10/18-S (Set)	
	E Juego por lastre para FS10/18-S (Set)	
	D ECO Ballast FS-EW (Set)	Item No. 520501
	UK ECO Ballast FS-EW (Set)	
	F Set de remplissage FS-EW (Set)	
	I Set di ballast per FS-EW (Set)	
	E Juego por lastre para FS-EW (Set)	
	D Aluminiumseil Durchmesser 9 mm; Querschnitt 50 mm ²	Item No. 900254
	UK Aluminum cable, diameter 9 mm; cross section 50 mm ²	
	F Câble alu, diamètre 9mm ; section 50mm ²	
	I Cavo in alluminio, diametro 9 mm; sezione 50 mm ²	
	E Cuerda de aluminio diámetro 9 mm; superficie útil 50 mm ²	
	D Aluminiumrunddraht; Durchmesser 8 mm	Item No. 900255
	UK Aluminum round wire; Diameter 8 mm	
	F Fil alu ; diamètre 8mm	
	I Filo rotondo in alluminio; diametro 8 mm	
	E Alambre redondo de aluminio; diámetro 8 mm	

CS+ ballasted PV-Mounting System



CS+







	D ConSole+ (inkl. Montagematerial und U-Profile)	Item No. 520075-K
	UK ConSole+ (incl. Mounting material and U-Profile)	
	F ConSole+ (incl. Material de montage e U-Profilé)	
	I ConSole+ (incl. Materiale di montaggio e U-Profilato)	
	E ConSole+ (incl. Material de montaje y U-perfil)	
	D Streamliner+	Item No. 520076
	UK Streamliner+	
	F Streamliner+	
	I Streamliner+	
	E Streamliner+	
	D Verlängerungsschienen für ConSole 4.1, 4.2, 5.2, 6.2	Item No. 460001
	UK Elongation rails for ConSole 4.1, 4.2, 5.2, 6.2	
	F Rails de rallonge pour ConSole 4.1, 4.2, 5.2, 6.2	
	I Set di prolunga per ConSole 4.1, 4.2, 5.2, 6.2	
	E Prolongación para ConSole 4.1, 4.2, 5.2, 6.2	
	D Montagematerial für ConSole 4.1, 4.2, 5.2, 6.2, CS+	Item No. 420022
	UK Mounting material for ConSole 4.1, 4.2, 5.2, 6.2, CS+	
	F Material de montage pour ConSole 4.1, 4.2, 5.2, 6.2, CS+	
	I Materiale di montaggio per ConSole 4.1, 4.2, 5.2, 6.2, CS+	
	E Material de montaje para ConSole 4.1, 4.2, 5.2, 6.2, CS+	
	D ConSole Clip	Item No. 920106
	UK ConSole Clip	
	F ConSole Clip	
	I ConSole Clip	
	E ConSole Clip	
	D Aluminium U-Profil 1035 mm ConSole 4.2, 5.2,6.2, CS+	Item No. 400005
	UK Aluminium U-Profile 1035 mm ConSole 4.2, 5.2,6.2, CS+	
	F Aluminium U-Profilé 1035 mm ConSole 4.2, 5.2,6.2, CS+	
	I Alluminio U-Profilato 1035 mm ConSole 4.2, 5.2,6.2, CS+	
	E Aluminio U-Perfil 1035 mm ConSole 4.2, 5.2,6.2, CS+	

Roof Integrated

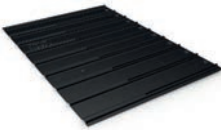



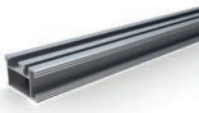
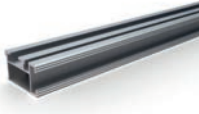



ISSE

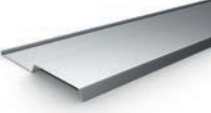

	D	Platte 1100 x 1600 mm	Item No.	500007
	UK	Plate 1100 x 1600 mm		
	F	Plaque 1100 x 1600 mm		
	I	Pannello 1100 x 1600 mm		
	E	Plancha 1100 x 1600 mm		
	D	InterSole Anker	Item No.	860004
	UK	InterSole Anchor		
	F	InterSole Ancre		
	I	InterSole Ancoraggio		
	E	InterSole Gancho		
	D	Winkel Standard	Item No.	860010
	UK	Bracket Standard		
	F	Equerre standard		
	I	Squadretta Standard		
	E	Escuadra de montaje estándar		
	D	Winkel Low	Item No.	860011
	UK	Bracket Low		
	F	Equerre basse		
	I	Squadretta Low		
	E	Escuadra de montaje baja		
	D	Montageschiene 3000 mm	Item No.	400018
	UK	Mounting rail 3000 mm		
	F	Profilé de montage 3000 mm		
	I	InterSole Guida in alluminio 3000 mm		
	E	InterSole Perfil 3000 mm		
	D	Montageschiene Zuschnitt/m	Item No.	460018
	UK	Mounting Rail custom cut /m		
	F	Profilé de montage coupe/m		
	I	InterSole Guida in alluminio su misura /m		
	E	Intersole Perfil a medida /m		
	D	InterSole Montageschiene 3000mm (schwarz)	Item No.	400018-B
	UK	InterSole Mounting rail 3000mm (black)		
	F	InterSole Profilé de montage 3000 mm (noir)		
	I	InterSole Guida in alluminio 3000 mm (nero)		
	E	InterSole Perfil 3000 mm (negro)		
	D	Montageschiene Zuschnitt /m (schwarz)	Item No.	460018-B
	UK	Mounting Rail custom cut /m (black)		
	F	Profilé de montage coupe/m (noir)		
	I	InterSole Guida in alluminio su misura /m (nero)		
	E	Intersole Perfil a medida /m (negro)		

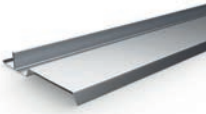

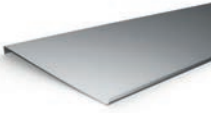
	D InterSole Schienenverbinder	Item No. 400025
	UK InterSole Rail connector	
	F InterSole Raccord de profilés de montage	
	I InterSole Connettore per guida	
	E InterSole Carril de unión	
	D InterSole Anschlußblech UNTEN	Item No. 700002
	UK InterSole Gutter LOWER	
	F InterSole Esthétivette INFÉRIEURE	
	I InterSole Scossalina INFÉRIORE	
	E InterSole Chapa de protección INFERIOR	
	D InterSole Anschlußblech UNTEN (schwarz)	Item No. 700002-B
	UK InterSole Gutter LOWER (black)	
	F InterSole Esthétivette INFÉRIEURE (noire)	
	I InterSole Scossalina INFÉRIORE (nera)	
	E InterSole Chapa de protección INFERIOR (negro)	
	D InterSole Anschlußblech SEITLICH	Item No. 700001
	UK InterSole Gutter SIDE	
	F InterSole Esthétivette LATÉRALE	
	I InterSole Scossalina LATÉRALE	
	E InterSole Chapa de protección LATERAL	
	D InterSole Anschlußblech SEITLICH (schwarz)	Item No. 700001-B
	UK InterSole Gutter SIDE (black)	
	F InterSole Esthétivette LATÉRALE (noire)	
	I InterSole Scossalina LATÉRALE (nera)	
	E InterSole Chapa de protección LATERAL (negro)	
	D InterSole Anschlussblech SEITLICH Flachziegel	Item No. 700103
	UK InterSole Gutter SIDE flat tiles	
	F Tôle de raccordement InterSole LATÉRALE tuiles plates	
	I Lamiera di giunzione LATÉRALE Intersole per tegole piane	
	E Intersole chapa de unión teja plana LATERAL	
	D InterSole Anschlussblech SEITLICH Flachziegel (schwarz)	Item No. 700103-B
	UK InterSole Gutter SIDE flat tiles (black)	
	F Tôle de raccordement InterSole LATÉRALE tuiles plates (noir)	
	I Lamiera di giunzione LATÉRALE Intersole per tegole piane (nera)	
	E Intersole chapa de unión teja plana LATERAL (negro)	
	D InterSole Anschlußblech OBEN	Item No. 700003
	UK InterSole Gutter UPPER	
	F InterSole Esthétivette SUPÉRIEURE	
	I InterSole Scossalina SUPÉRIORE	
	E InterSole Chapa de protección SUPERIOR	



	D InterSole Anschlussblech OBEN (schwarz)	Item No. 700003-B
	UK InterSole Gutter UPPER (black)	
	F InterSole Esthétivette SUPERIEURE (noire)	
	I InterSole Scossalina SUPERIORE (nera)	
	E InterSole Chapa de protección SUPERIOR (negro)	
	D Wasserfeste Schürze 400 x 6000 mm	Item No. 300002 schwarz
	UK Sealing strip 400 x 6000 mm	300003 rot
	F Tablier de protection 400 x 6000 mm	
	I Membrana impermeabile 400 x 6000 mm	
	E Faldon de estanqueidad 400 x 6000 mm	
	D Wasserfeste Schürze 400 x 12000 mm	Item No. 300004 schwarz
	UK Sealing strip 400 x 12000 mm	300005 rot
	F Tablier de protection 400 x 12000 mm	
	I Membrana impermeabile 400 x 12000 mm	
	E Faldon de estanqueidad 400 x 12000 mm	
	D Wasserfeste Schürze 500 x 6000 mm	Item No. 300006 schwarz
	UK Sealing strip 500 x 6000 mm	300009 rot
	F Tablier de protection 500 x 6000 mm	
	I Membrana impermeabile 500 x 6000 mm	
	E Faldon de estanqueidad 500 x 6000 mm	
	D Komtriband 20 x 4000 mm	Item No. 300100
	UK Sealing tape MPA 20 x 4000 mm	
	F Bande compressible 20 x 4000 mm	
	I Bandella di compressione 20 x 4000 mm	
	E Cinta de dilatación.20.x.4000.mm.....	
	D Kleber für wasserfeste Schürze 290 ml	Item No. 300000
	UK Sealing strip Glue 290 ml	
	F Adhésif pour tablier de protection 290 ml	
	I Colla per membrana impermeabile 290 ml	
	E Adesivo faldon de estanqueidad 290 ml	
	D Hafte	Item No. 720011
	UK Mounting clip	
	F Griffe	
	I Graffetta per scossaline	
	E Enganche	
	D Spenglerschraube 4,5 x 45	Item No. 900011
	UK Screw neoprene washer 4,5 x 45	
	F Vis autoforeuse 4,5 x 45	
	I Vite autoforante con rondella in neoprene 4,5 x 45	
	E Tornillo de rosca autocortante con arandela 4,5 x 45	



- D** Holzschraube Senkkopf 4,5 x 50
- UK** Wood screw countersunk 4,5 x 50
- F** Vis à bois avec tête fraisée 4,5 x 50
- I** Vite da legno testa piana 4,5 x 50
- E** Tornillo madera cabeza avellanada 4,5 x 50

Item No.

900021





- D** Servicepauschale InterSole Zeichnung
- UK** Service for InterSole layout
- F** Forfait de service de InterSole schémas
- I** Forfait de servizio InterSole disegno
- E** Servicio InterSole dibujo

Item No.

200007







ONE FOR ALL!









EINGEGANGEN 05. Sep. 2014		Zeichn. Nr.	420080
05.09.14 9237		RS1	
			
RS1		1	AL

RS1







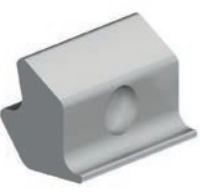
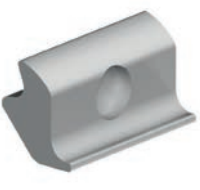



	D RS1	Item No. 420080
	UK RS1	
	F RS1	
	I RS1	
	E RS1	
	D RS1 (schwarz)	Item No. 420080-BE
	UK RS1 (black)	
	F RS1 (noire)	
	I RS1 (nero)	
	E RS1 (negro)	
	D Endklemme+	Item No. 420081
	UK End clamp+	
	F Bride simple+	
	I Morsetto terminale+	
	E Fijador lateral+	
	D Endklemme+ (schwarz)	Item No. 420081-BE
	UK End clamp+ (black)	
	F Bride simple+ (noire)	
	I Morsetto terminale+ (nero)	
	E Fijador lateral+ (negro)	
	D Mittelklemme+	Item No. 420082
	UK Middle clamp+	
	F Bride double+	
	I Morsetto intermedio+	
	E Fijador intermedio+	
	D Mittelklemme+ (schwarz)	Item No. 420082-BE
	UK Middle clamp+ (black)	
	F Bride double+ (noire)	
	I Morsetto intermedio+ (nero)	
	E Fijador intermedio+ (negro)	



	D S-5!® Stehfalzklemme E-Mini	Item No. 400254
	UK S-5!® Clamp for standing seam E-Mini	
	F S-5!® Bride pour couverture à joint debout E-Mini	
	I S-5!® Lamiera graffata E-Mini	
	E S-5!® Fijador E-Mini	
	D S-5!® Stehfalzklemme Z-Mini	Item No. 400255
	UK S-5!® Clamp for standing seam Z-Mini	
	F S-5!® Bride pour couverture à joint debout Z-Mini	
	I S-5!® Lamiera graffata Z-Mini	
	E S-5!® Fijador Z-Mini	
	D S-5!® Stehfalzklemme S-Mini	Item No. 400259
	UK S-5!® Clamp for standing seam S-Mini	
	F S-5!® Bride pour couverture à joint debout S-Mini	
	I S-5!® Lamiera graffata S-Mini	
	E S-5!® Fijador S-Mini	
	D S-5!® Stehfalzklemme R-465	Item No. 400252
	UK S-5!® Clamp for standing seam R-465	
	F S-5!® Bride pour couverture à joint debout R-465	
	I S-5!® Lamiera graffata R-465	
	E S-5!® Fijador R-465	
	D S-5!® Stehfalzklemme A-Mini	Item No. 400289
	UK S-5!® Clamp for standing seam A-Mini	
	F S-5!® Bride pour couverture à joint debout A-Mini	
	I S-5!® Lamiera graffata A-Mini	
	E S-5!® Fijador A-Mini	
	D S-5!® Stehfalzklemme K-Grip Mini	Item No. 400284
	UK S-5!® Clamp for standing seam K-Grip Mini	
	F S-5!® Bride pour couverture à joint debout K-Grip Mini	
	I S-5!® Lamiera graffata K-Grip Mini	
	E S-5!® Fijador K-Grip Mini	
	D S-5!® Einsatz für Stehfalzklemme K-Grip Mini (GXM10)	Item No. 400288
	UK S-5!® insert for Clamp for standing seam K-Grip Mini (GXM10)	
	F S-5!® Bride pour couverture à joint debout K-Grip Mini (GXM10)	
	I S-5!® Lamiera graffata K-Grip Mini (GXM10)	
	E S-5!® Fijador K-Grip Mini (GXM10)	
	D S-5!® Einsatz für Stehfalzklemme K-Grip Mini (GXM50)	Item No. 400285
	UK S-5!® insert for Clamp for standing seam K-Grip Mini (GXM50)	
	F S-5!® Bride pour couverture à joint debout K-Grip Mini (GXM50)	
	I S-5!® Lamiera graffata K-Grip Mini (GXM50)	
	E S-5!® Fijador K-Grip Mini (GXM50)	



	D S-5!® Stehfalzklemme R-465-Mini	Item No. 400563
	UK S-5!® Clamp for standing seam R-465-Mini	
	F S-5!® Bride pour couverture à joint debout R-465-Mini	
	I S-5!® Lamiera graffata R-465-Mini	
	E S-5!® Fijador R-465-Mini	
	D Kalzip Stehfalzklemme Typ FS	Item No. 400256
	UK Kalzip clamp for standing seam Typ FS	
	F Kalzip bride pour couverture à joint debout Typ FS	
	I Kalzip lamiera graffata Typ FS	
	E Kalzip fijador para junta alzada Typ FS	
	D Rib-Roof Stehfalzklemme 465	Item No. 400257
	UK Rib-Roof clamp for standing seam R-465	
	F Rib-Roof bride pour couverture à joint debout R-465	
	I Rib-Roof lamiera graffata R-465	
	E Rib-Roof fijador para junta alzada R-465	
	D Rib-Roof Stehfalzklemme 500	Item No. 400258
	UK Rib-Roof clamp for standing seam R-500	
	F Rib-Roof bride pour couverture à joint debout R-500	
	I Rib-Roof lamiera graffata R-500	
	E Rib-Roof fijador para junta alzada R-500	
	D LC1 Endklemme für Laminate	Item No. 420084
	UK LC1 End clamp for laminate	
	F LC1 Bride simple pour laminés	
	I LC1 Bride simple pour laminés	
	E LC1 Fijador lateral para laminados	
	D LC1 Endklemme (schwarz) für Laminate	Item No. 420084-B
	UK LC1 End clamp (black) for laminate	
	F LC1 Bride simple (noire) pour laminés	
	I LC1 Morsetto terminale (nero) per laminati	
	E LC1 Fijador lateral (negro) para laminados	
	D LC1 Mittelklemme für Laminate	Item No. 420085
	UK LC1 Middle clamp for laminate	
	F LC1 Bride double pour laminés	
	I LC1 Morsetto intermedio per laminato	
	E LC1 Fijador intermedio para laminados	
	D LC1 Mittelklemme (schwarz) für Laminate	Item No. 420085-B
	UK LC1 Middle clamp (black) for laminate	
	F LC1 Bride double (noire) pour laminés	
	I LC1 Morsetto intermedio (nero) per laminati	
	E LC1 Fijador intermedio (negro) para laminados	



[mm]

400254

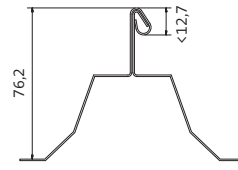
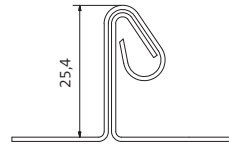
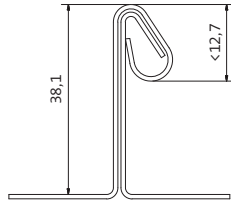

400255

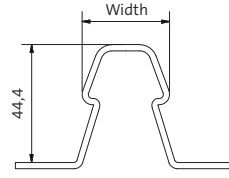
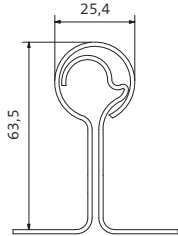

400259

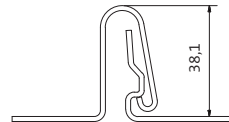
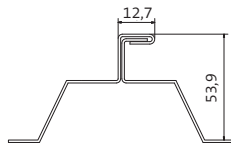
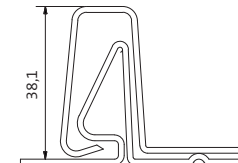
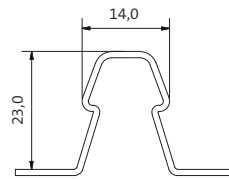
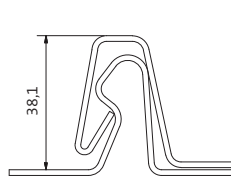
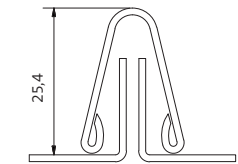
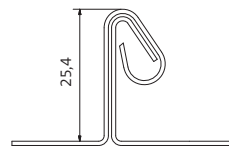
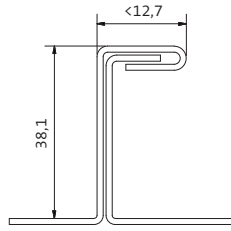

400252



400563

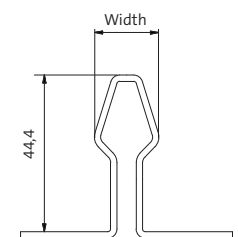

400284



400288

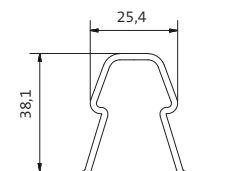

400284



400285

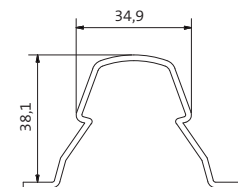
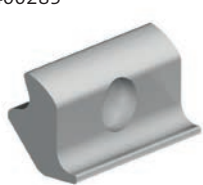









	D 6kt. Sperrzahnmutter mit Flansch M8	Item No. 900001
	UK Hexagon Nut w. serration M8	
	F Ecrou M8	
	I Dado flang. M8	
	E Tuerca dentada M8	
	D 6kt. Mutter ISO 4032 - M8 A2-70	Item No. 900036
	UK Hexagon nut ISO 4032 - M8 A2-70	
	F Ecrou ISO 4032 - M8 A2-70	
	I Dado esagonale ISO 4032-M8 A2-70	
	E Tuerca hexagonal ISO 4032 - M8 A2-70	
	D 6kt. Sperrzahnschraube M8 x 35 mit Flansch	Item No. 900025
	UK Hexag. bolt M8 x 35 with serration	
	F Vis tête hexagonale et embase crantée M8 x 35	
	I Vite flangiata M8 x 35 con sicura	
	E Tornillo M8 x 35 con corona autoblocante DIN 6921	
	D 6kt. Sperrzahnschraube M8 x 14 mit Flansch	Item No. 900016
	UK Hexag. Flange bolt with serration M8 x 14	
	F Vis tête hexagonale et embase crantée M8 x 14	
	I Vite flangiata con sicura M8 x 14	
	E Tornillo con bloqueo dentado con reborde M8 x 14	
	D Hammerkopfschraube M8 x 20	Item No. 900009
	UK Hammerhead bolt M8 x 20	
	F Vis tête marteau M8 x 20	
	I Vite testa a martello M8 x 20	
	E Tornillo con cabeza de martillo M8 x 20	
	D Hammerkopfschraube M8 x 25	Item No. 900007
	UK Hammerhead bolt M8 x 25	
	F Vis tête marteau M8 x 25	
	I Vite testa a martello M8 x 25	
	E Tornillo con cabeza de martillo M8 x 25	
	D 6kt. Schraube DIN931 u. Mutter DIN934	Item No. 900015
	UK Hexagon Bolt DIN931 and Hexagon Flange DIN934	
	F Vis tête hexagonale DIN931 avec écrou DIN 934	
	I Vite flangiata DIN931 e Dado flangiato DIN934	
	E Hexag. Bolt DIN931 y Tuerca DIN934	







	D Kabelclip 0,7-3mm mit Kabelbinder	Item No. 900035
	UK Edge Clip 0,7-3mm with cable strap	
	F Lanière assemblée pour bord de cadre 0,7-3 mm	
	I Clip di fissazione laterale 0,7-3 mm, con cavo	
	E Clip de fijación lateral 0,7-3 mm, con brida	
	D Kabelhalter 90°	Item No. 900260
	UK Wire clip 90°	
	F Porte-câble 90°	
	I Portacavo 90°	
	E Soporte de cables	
	D Kabelclip Omega	Item No. 900261
	UK Wire clip Omega	
	F Clip de fixation de câbles Omega	
	I Clip Omega	
	E Clip de cables Omega	
	D Diebstahlsicherung Flüssigmetall	Item No. 900230
	UK Anti theft liquid metal	
	F Protection antivol - Métal liquide	
	I Protezione antifurto - Metallo liquido	
	E Protección antirrobo - Metal líquido	
	D UNI-Falzklamme	Item No. 900240
	UK UNI- Frame L-foot clamp for grounding	
	F UNI-Bride de serrage	
	I UNI-Morsetto per coperture a giunto aggraffato	
	E UNI-Fijador para cubiertas plegadas	
	D UNI- Erdungsklemme	Item No. 900241
	UK UNI-Grounding clamp	
	F UNI-Borne de terre	
	I UNI-Morsetto di messa a terra	
	E UNI-Terminal de puesta a tierra	
	D Befestigungsset für SolarEdge Optimizer (Set)	Item No. 420271
	UK Attachmentset for SolarEdge Optimizer	
	F Set de fixation pour Solaredge Optimizer	
	I Set di montaggio per ottimizzatore di potenza SolarEdge	
	E Juego de fijación para SolarEdge Optimizer	









	D Winkel M10	Item No. 420014
	UK Bracket M10	
	F Equerre M10	
	I Squadretta M10	
	E Escuadra M10	
	D Winkel M12	Item No. 420012
	UK Bracket M12	
	F Equerre M12	
	I Squadretta M12	
	E Escuadra M12	
	D Winkel M10 (Anbindung versetzt)	Item No. 420131
	UK Bracket M10 (offset connection)	
	F Equerre M10 (fixation décentrée)	
	I Squadretta M10 (fissaggio decentrato)	
	E Escuadra M10 (orificio de fijación decentrado)	
	D Winkel M12 (Anbindung versetzt)	Item No. 420130
	UK Bracket M12 (offset connection)	
	F Equerre M12 (fixation décentrée)	
	I Squadretta M12 (fissaggio decentrato)	
	E Escuadra M12 (orificio de fijación decentrado)	
	D Winkel UK M8, (SET)	Item No. 420352
	UK UK M8 bracket, (SET)	
	F Équerre UK M8, (SET)	
	I Angolare UK M8, (SET)	
	E Escuadra UK M8, (SET)	
	D Microinverter Befestigungswinkel, Set	Item No. 400270
	UK Microinverter mounting bracket, Set	
	F Équerre de fixation micro-onduleur VS, set	
	I Piastra angolare per microinverter VS, set	
	E Microinversor escuadra de fijación, set	

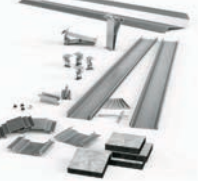

	D	Vorsatzgerät SFS DS-K 265 für Akkuschauber	Item No. 999900
	UK	Attachment SFS DS-K 265 for cordless screwdriver	
	F	Adaptateur SFS DS-K 265 pour visseuse électrique	
	I	Adattatore SFS DS-K 265 per avvitatore a batteria	
	E	Adaptator SFS DS-K 265 por atornilladora de acu	
	D	Bohrvolage MetaSole+ mit Nieten	Item No. 999924
	UK	Drill template MetaSole+ with rivets	
	F	Gabarit de perçage rivets MS+	
	I	Dima di foratura per rivetti MS+	
	E	Plantilla de taladrado MS+ remachado	
	D	Powerbird Solar für Niete	Item No. 999930
	UK	Powerbird Solar for rivet	
	F	Powerbird Solar pour rivet	
	I	Powerbird Solar per rivetti	
	E	Powerbird Solar para remanche	
	D	Bohrkrone Multiträger	Item No. 999921
	UK	Core drill bit multi support	
	F	Couronne de carottage multi-support	
	I	Seghe a tazza multiplo supporto	
	E	Broca de perforacion soporte multiple	
	D	Montage-Bit - Stehfalzklemme	Item No. 900250
	UK	Assembly bit - standing seam clamp	
	F	Embout de montage - Toiture à pincement verticale	
	I	Punta di montaggio - Morsetti per lamiera aggraffata	
	E	Punta para instalación - Junta alzada	



	D	RS1 Handmuster	Item No.	500108
	UK	RS1 sample		
	F	RS1 Echantillon		
	I	RS1 Campionatura		
	E	RS1 Muestra		
	D	VS+ Handmuster	Item No.	500106
	UK	VS+ sample		
	F	VS+ Echantillon		
	I	VS+ Campionatura		
	E	VS+ Muestra		
	D	MS+ Handmuster	Item No.	500107
	UK	MS+ sample		
	F	MS+ Echantillon		
	I	MS+ Campionatura		
	E	MS+ Muestra		
	D	FS10-S Handmuster	Item No.	500109
	UK	FS10-S sample		
	F	FS10-S Echantillon		
	I	FS10-S Campionatura		
	E	FS10-S Muestra		
	D	VS+ Systemmuster	Item No.	500065
	UK	VS+ system sample		
	F	VS+ Echantillon de système		
	I	VS+ Campionatura sistema		
	E	VS+ Muestra del sistema		
	D	InterSole Handmuster	Item No.	500018
	UK	InterSole SE sample		
	F	InterSole SE Echantillon		
	I	InterSole SE campionatura		
	E	InterSole SE Muestra		
	D	Display VS+ /MS+	Item No.	500113
	UK	Display VS+ /MS+		
	F	Affichage VS+ /MS+		
	I	Display VS+ /MS+		
	E	IPantalla VS+ /MS+		

Renusol Europe GmbH
Piccoloministrasse 2
51063 Cologne
Germany

Telephone: +49 221 788707-0
Fax: +49 221 788707-99
Email: info@renusol.com
www.renusol.com

Sales department
Telephone: +49 221 788707-19
Fax: +49 221 788707-97
Email: sales-support@renusol.com

Application technicians
Telephone: +49 221 788707-29
Fax: +49 221 788707-98
Email: technical-support@renusol.com

- DE | Abbildungen und Texte entsprechen dem aktuellen technischen Stand bei Drucklegung, Änderungen vorbehalten.
- GB | The images and texts in these instructions relate to the latest technology at the time of printing, subject to modifications.
- FR | Les illustrations et textes sont conformes à l'état de la technique au moment de mise sous presse. Sous toutes réserves de modifications.
- IT | Figure e testi corrispondono allo stato più attuale della tecnica al momento dell'ordine di stampa. Con riserva di modifiche.
- ES | Las imágenes y los textos se corresponden al estado actual de la técnica en el momento de la impresión, reservado el derecho a las modificaciones.
- NL | Afbeeldingen en teksten voldoen aan de actuele stand van de techniek op het moment van ter perse gaan. Wijzigingen voorbehouden.
- DK | Afbildninger og tekster overholder den tekniske stand ved trykningen, der tages forbehold for ændringer.
- SE | Bilder och texter motsvarar den nuvarande tekniska tillstånd vid tidpunkten för tryckning, med förbehåll för ändringar.
- CZ | Vyobrazení a texty odpovídají aktuálnímu technickému stavu při odevzdání do tisku. Změny vyhrazeny.
- PL | Ilustracje i teksty odpowiadają stanowi techniki aktualnemu w chwili oddania instrukcji do druku. Zastrzega się prawo do zmian.
- LT | Spausdinami paveikslėliai ir tekstas atitinka naujausią technikos lygį. Pasilieka me teisę į pakeitimus.
- HU | Az ábrák és a szövegek a nyomtatás időpontjában rendelkezésünkre álló legfrissebb műszaki ismereteknek felelnek meg; a módosítások jogát fenntartjuk.



Renusol Europe GmbH

Piccoloministr. 2
51063 Köln

+49 221 788707-0

+49 221 788707-99

info@renusol.com

www.renusol.com