

Connector

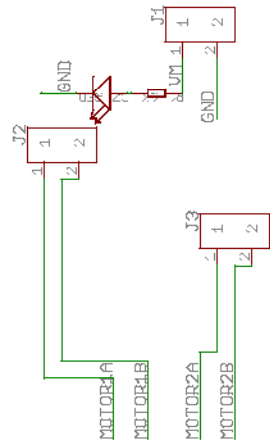

booster to 12V

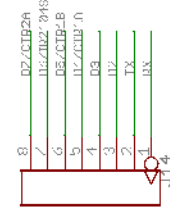
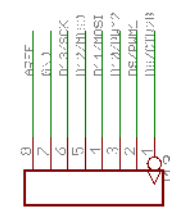
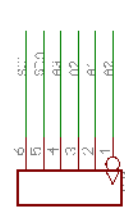
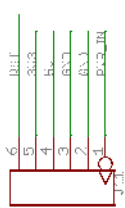
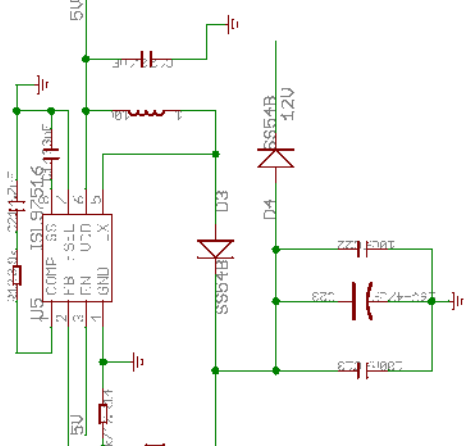

D8: Motor_1 speed control
 D4/D5: Rotation Control of Motor_1
 D10: Motor_2 speed control
 D7/D8: Rotation Control of Motor_2
 D6: System Enable

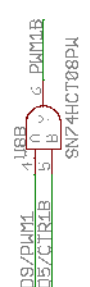
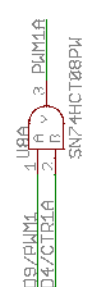
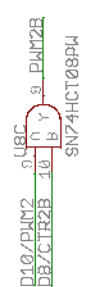
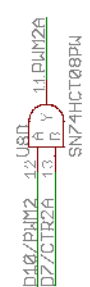

5V 1.4 VCC 8NC 2 GND

