

DS-2CD2F42FWD-I(W)(S)



Key Features

- Up to 4 megapixel 2688×1520 @ 20fps resolution
- Standard video compression with high compression ratio, ROI (region of interest) encoding
- Progressive scan CMOS, capture motion video without incised margin
- Support dual stream, and the sub-stream for mobile surveillance
- Built-in Micro SD / SDHC / SDXC card slot, up to 128GB
- Two-way audio (-S)
- Support 120dB wide dynamic range
- Audio I/O (-S)
- Support wifi (-W)
- Support pan and tilt
- High-performance and long service life Infrared LED, Approx. 10 meters IR range
- IR cut filter with auto switch
- PoE (Power over Ethernet)
- Electronic shutter for different surveillance environments
- Other functions: alarm, mirror, etc
- Support VCA, which is compatible with NVR for the second time of video searching and analysing

Specification

Model	DS-2CD2F42FWD-IWS
Parameter	4 Megapixel CMOS ICR Infrared Network Dome Camera
Camera	
Image Sensor	1/3" Progressive Scan CMOS
Min. Illumination	0.01Lux @ (F1.2, AGC ON) ,0 Lux with IR 0.028Lux @ (F2.0, AGC ON) ,0 Lux with IR
Shutter Speed	1/3 s to 1/10,000 s
Lens	2.8mm, 4mm, 6mm @ F2.0

Lens Mount	M12
Day & Night	IR cut filter with auto switch
Digital Noise Reduction	3D DNR
Wide Dynamic Range	120dB
Angle Adjustment	Motorized: Pan: -90° - 90°, Tilt: 0° - 75°
Compression Standard	
Video Compression	H.264/ MJPEG
H.264 Type	Main Profile
Video Bit Rate	256 Kbps – 16 Mbps
Dual Stream	Yes
Image	
Max. Resolution	2688×1520
Frame Rate	50Hz: 20fps (2688×1520), 25fps(1920×1080), 25fps(1280×720) 60Hz: 20fps (2688×1520), 30fps (1920×1080), 30fps(1280×720)
Image Settings	Rotate mode, Saturation, Brightness, Contrast adjustable by client software or web browser
Backlight compensation	Yes, zone optional
ROI	Support
Network	
Network Storage	NAS (Support NFS,SMB/CIFS)
Alarm Trigger	Intrusion Detection, Line Crossing detection, Motion detection, Dynamic analysis, Tampering alarm, Network disconnect , IP address conflict, Storage exception
Protocols	TCP/IP,ICMP,HTTP,HTTPS,FTP,DHCP,DNS,DDNS,RTP,RTSP,RTCP, PPPoE,NTP,UPnP,SMTP,SNMP,IGMP,802.1X,QoS,IPv6,Bonjour
Security	One-key reset, Flash-prevention, dual stream, heartbeat, mirror, password protection, privacy mask, watermark, IP address filtering, Anonymous access
Standard	ONVIF, PSIA, CGI, ISAPI
Interface	
Communication Interface	1 RJ45 10M/100M Ethernet interface
Alarm interface	1 alarm I/O (-S)
Audio interface	1 audio I/O (-S)
On-board storage	Built-in Micro SD / SDHC / SDXC slot, up to 128 GB
Reset Button	Yes
Wi-Fi Specification (-W)	
Wireless Standards	IEEE802.11b, 802.11g, 802.11n
Frequency Range	2.4 GHz ~ 2.4835 GHz

Channel Bandwidth	20/40MHz Support
Protocols	802.11b: CCK, QPSK, BPSK 802.11g/n: OFDM
Security	64/128-bit WEP, WPA/WPA2, WPA-PSK/WPA2-PSK, WPS
Transmit Output Power	11b: 17±1.5dBm @ 11Mbps 11g: 14±1.5dBm @ 54Mbps 11n: 12.5±1.5dBm
Receive Sensitivity	11b: -90dBm @ 11Mbps (Typical) 11g: -75dBm @ 54Mbps (Typical) 11n: -74dBm (Typical)
Transfer Rates	11b: 11Mbps 11g: 54Mbps 11n: up to 150Mbps
Wireless Range	50m (depend on environment)
General	
Operating Conditions	-10 °C – 40 °C (14 °F – 104 °F) Humidity 95% or less (non-condensing)
Power Supply	12 V DC ± 10% PoE (802.3af)
Power Consumption	Max. 5 W (Max. 7 W with IR cut filter on) Max. 9W with pan and tilt
IR Range	Approx. 10 meters
Dimensions	Φ 119.93×87.08 mm
Weight	500g (1.1 lbs)

Order Models

DS-2CD2F42FWD-I, DS-2CD2F42FWD-IW, DS-2CD2F42FWD-IS, DS-2CD2F42FWD-IWS

Dimensions

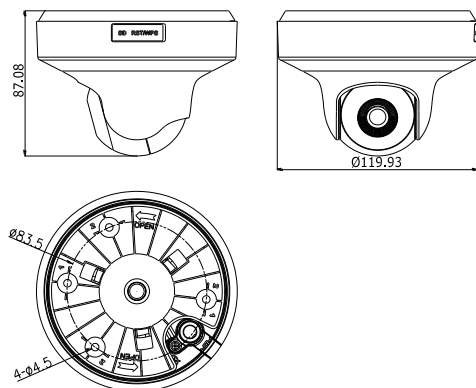

Accessory



DS-1294ZJ Wall Mount