



INSTRUCTION MANUAL
MT565
INSULATION TESTER &
BLUETOOTH MULTIMETER



Contents

Page no

| | |
|---|----|
| 1. Introduction..... | 4 |
| 2. Safety Symbols..... | 4 |
| 3. Safety Instructions..... | 5 |
| 4. Controls and Jacks..... | 6 |
| 5. Symbols and Annunciators..... | 7 |
| 6. Operating Instructions..... | 8 |
| 6.1. DC Voltage Measurements..... | 8 |
| 6.2. AC Voltage (Frequency, Duty Cycle) Measurement..... | 9 |
| 6.3. MV Voltage Measurements..... | 9 |
| 6.4. DC Current Measurements..... | 10 |
| 6.5. AC Current (Frequency, Duty Cycle) Measurement..... | 11 |
| 6.6. Resistance Measurements..... | 12 |
| 6.7. Continuity Check..... | 12 |
| 6.8. Diode Test..... | 13 |
| 6.9. Capacitance Measurements..... | 13 |
| 6.10. Temperature Measurements..... | 14 |
| 6.11. Frequency (Duty Cycle) Measurements (Electronic)..... | 14 |
| 6.12. Insulation Resistance Measurements..... | 15 |
| 6.13. Power Tools and Small Appliances..... | 15 |
| 6.14. DAR and PI Insulation Tests..... | 16 |
| 6.15. Mode/Bluetooth..... | 17 |
| 7. Auto Ranging/Manual Range Selection..... | 18 |
| 7.1. MIN/MAX..... | 18 |
| 7.2. Relative Mode..... | 18 |
| 7.3. Display Backlight..... | 18 |
| 7.4. Hold..... | 19 |
| 7.5. Peak Hold..... | 19 |
| 7.6. Data Record (Store/Recall)..... | 19 |
| 7.7. Low Battery Indication..... | 19 |
| 8. Maintenance..... | 20 |
| 8.1. Battery Installation..... | 20 |
| 8.2. Replacing the Fuses..... | 21 |
| 9. Specifications..... | 21 |
| 9.1. DC Voltage..... | 21 |
| 9.2. AC Voltage (50 to 1000Hz)..... | 21 |
| 9.3. DC Current..... | 22 |
| 9.4. AC Current..... | 22 |
| 9.5. Resistance..... | 22 |
| 9.6. Capacitance..... | 21 |
| 9.7. Frequency (Electronic)..... | 23 |
| 9.8. Frequency (Electrical)..... | 23 |
| 9.9. Duty Cycle..... | 23 |
| 9.10. Temperature Measurements - K-Type..... | 23 |
| 9.11. Meg OHMS..... | 24 |
| 9.12. Low OHMS..... | 24 |
| 9.13. General Specifications..... | 25 |

1. INTRODUCTION

This meter measures AC/DC Voltage, AC/DC Current, Resistance, Capacitance, Frequency (electrical & electronic), Duty Cycle, Diode Test, Insulation Test, and Continuity plus Thermocouple Temperature. It can store and recall data. It features a waterproof, rugged design for heavy duty use. Proper use and care of this meter will provide many years of reliable service.

2. SAFETY SYMBOLS



This symbol adjacent to another symbol, terminal or operating device indicates that the operator must refer to an explanation in the Operating Instructions to avoid personal injury or damage to the meter.

WARNING

This WARNING symbol indicates a potentially hazardous situation, which if not avoided, could result in death or serious injury.

CAUTION

This CAUTION symbol indicates a potentially hazardous situation, which if not avoided, may result in damage to the product.



This symbol advises the user that the terminal(s) so marked must not be connected to a circuit point at which the voltage with respect to earth ground exceeds (in this case) 1000 VAC or VDC.



This symbol adjacent to one or more terminals identifies them as being associated with ranges that may, in normal use, be subjected to particularly hazardous voltages. For maximum safety, the meter and its test leads should not be handled when these terminals are energized.



This symbol indicates that a device is protected throughout by double insulation or reinforced insulation.

PER IEC1010 OVERVOLTAGE INSTALLATION CATEGORY OVERVOLTAGE CATEGORY I

Equipment of OVERVOLTAGE CATEGORY I is equipment for connection to circuits in which measures are taken to limit the transient overvoltages to an appropriate low level.

Note – Examples include protected electronic circuits.

OVERVOLTAGE CATEGORY II

Equipment of OVERVOLTAGE CATEGORY II is energy-consuming equipment to be supplied from the fixed installation.

Note – Examples include household, office, and laboratory appliances.

OVERVOLTAGE CATEGORY III

Equipment of OVERVOLTAGE CATEGORY III is equipment in fixed installations.

Note – Examples include switches in the fixed installation and some equipment for industrial use with permanent connection to the fixed installation.

OVERVOLTAGE CATEGORY IV

Equipment of OVERVOLTAGE CATEGORY IV is for use at the origin of the installation.

Note – Examples include electricity meters and primary over-current protection equipment

3. SAFETY INSTRUCTIONS

This meter has been designed for safe use, but must be operated with caution. The rules listed below must be carefully followed for safe operation.

1. **NEVER** apply voltage or current to the meter that exceeds the specified maximum:

| Input Protection Limits | |
|--|------------------------------|
| Function | Maximum Input |
| V DC or V AC | 1000V DC/AC RMS |
| mA AC/DC | 500mA 1000V fast acting fuse |
| A AC/DC | 10A 1000V fast acting fuse |
| Frequency, Resistance, Capacitance, Duty Cycle, Diode Test, Continuity | 1000V DC/AC RMS |
| Temperature | 1000V DC/AC RMS |
| Surge Protection: | 8kV peak per IEC 61010 |

2. **USE EXTREME CAUTION** when working with high voltages.
3. **DO NOT** measure voltage if the voltage on the "COM" input jack exceeds 1000V above earth ground.
4. **NEVER** connect the meter leads across a voltage source while the function switch is in the current, resistance, or diode mode. Doing so can damage the meter.
5. **ALWAYS** discharge filter capacitors in power supplies and disconnect the power when making resistance or diode tests.
6. **ALWAYS** turn off the power and disconnect the test leads before opening the covers to replace the fuse or batteries.
7. **NEVER** operate the meter unless the back cover and the battery and fuse covers are in place and fastened securely.

If the equipment is used in a manner not specified by the manufacturer, the protection provided by the equipment may be impaired.





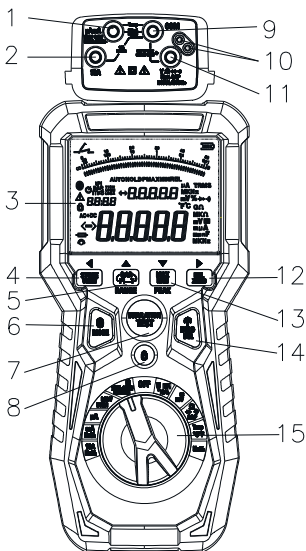

4. CONTROLS AND JACKS

- | | |
|---|---|
| 1 - mA, μ A, temp, INS and Rlow input jacks | 8 - INSULATION LOCK button |
| 2 - 10A input jacks | 9 - COM input jack |
| 3 - 50,000 count LCD display | 10 - Input Terminal to operate the switched probe |
| 4 - STORE(VIEW) button | 11 - Positive input jack |
| 5 - TIME/PI/DAR(RANGE/DOWN) button | 12 - REL button |
| 6 - MODE(BLUE) button | 13 - MAX/MIN(PEAK/DOWN) button |
| 7 - INSULATION TEST button | 14 - HOLD/Backlight/DEL button |
| | 15 - Function switch |

Note: Tilt stand and battery compartment are on rear of unit.



5. SYMBOLS AND ANNUNCIATORS

| | | | |
|---|--------------------------------------|---|--------------------|
|  | Continuity |  | Low pass filtering |
|  | Diode test | | Timing symbol |
|  | Battery status | | Backlight |
| n | nano (10^{-9}) (capacitance) | | bargraph |
| μ | micro (10^{-6}) (amps, cap) | | |
| m | milli (10^{-3}) (volts, amps) | | |
| A | Amps | | |
| k | kilo (10^3) (ohms) | | |
| F | Farads (capacitance) | | |
| M | mega (10^6) (ohms) | | |
| Ω | Ohms | | |
| PEAK | Peak Hold | | |
| Hz | Hz Hertz (frequency) | | |
| V | Volts | | |
| % | Percent (duty ratio) | | |
| REL | Relative | | |
| AC | Alternating current | | |
| DC | Direct current | | |
| $^{\circ}\text{F}$ | Degrees Fahrenheit | | |
| $^{\circ}\text{C}$ | Degrees Centigrade | | |
| AUTO | Auto Range Timing | | |
| HOLD | Display hold | | |
| MIN | Minimum | | |
| MAX | Maximum | | |
| AC + DC | Alternating current + Direct current | | |
| TRMS | True RMS | | |
| LOG | Store | | |
| VIEW | Recall | | |
| AUTO | Auto Range | | |
|  | Resistance low operator indication | | |
|  | Bluetooth | | |

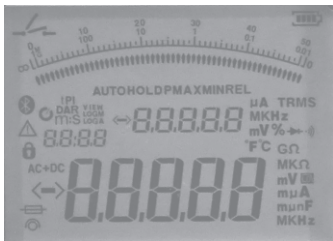

6. OPERATING INSTRUCTIONS

WARNING: Risk of electrocution. High-voltage circuits, both AC and DC, are very dangerous and should be measured with great care.

1. ALWAYS turn the function switch to the **OFF** position when the meter is not in use.
2. If "OL" appears in the display during a measurement, the value exceeds the range you have selected. Change to a higher range.

6.1. DC VOLTAGE MEASUREMENTS

CAUTION: Do not measure DC voltages if a motor on the circuit is being switched ON or OFF. Large voltage surges may occur that can damage the meter.

1. Set the function switch to the  position.
2. Press the MODE button to indicate "DC".
3. Insert the black test lead banana plug into the negative COM jack. Insert the red test lead banana plug into the positive V jack.
4. Touch the black test probe tip to the negative side of the circuit. Touch the red test probe tip to the positive side of the circuit.
5. Read the voltage on the display.



6.2. AC VOLTAGE (FREQUENCY, DUTY CYCLE) MEASUREMENT

CAUTION: Do not measure AC voltages if a motor on the circuit is being switched ON or OFF. Large voltage surges may occur that can damage the meter.

WARNING: Risk of Electrocution. The probe tips may not be long enough to contact the live parts inside some 240V outlets for appliances because the contacts are recessed deep in the outlets. As a result, the reading may show 0 volts when the outlet actually has voltage on it. Make sure the probe tips are touching the metal contacts inside the outlet before assuming that no voltage is present.

1. Set the function switch to the  position.
2. Press the **MODE** button to indicate "AC".
3. Insert the black test lead banana plug into the negative **COM** jack. Insert red test lead banana plug into the positive **V** jack.
4. Touch the black test probe tip to the neutral side of the circuit. Touch the red test probe tip to the "live" side of the circuit.
5. Read the voltage in the display.
6. Press the **MODE** button to indicate "Hz(%)".
7. Read the frequency on the main display and the duty on the auxiliary display.



6.3. MV VOLTAGE MEASUREMENTS

CAUTION: Do not measure mV voltages if a motor on the circuit is being switched ON or OFF. Large voltage surges may occur that can damage the meter.

1. Set the function switch to the mV position.
2. Press the **MODE** button to indicate "DC" or "AC".
3. Insert the black test lead banana plug into the negative **COM** jack. Insert the red test lead banana plug into the positive **V** jack.
4. Touch the black test probe tip to the negative side of the circuit. Touch the red test probe tip to the positive side of the circuit.
5. Read the mV voltage on the display.



6.4. DC CURRENT MEASUREMENTS

CAUTION: Do not make 20A current measurements for longer than 30 seconds. Exceeding 30 seconds may cause damage to the meter and/or the test leads.

1. Insert the black test lead banana plug into the negative **COM** jack.
2. For current measurements up to 5000 μ A DC, set the function switch to the **μ A** position and insert the red test lead banana plug into the **μ A/mA** jack.
3. For current measurements up to 400mA DC, set the function switch to the **mA** position and insert the red test lead banana plug into the **μ A/mA** jack.
4. For current measurements up to 20A DC, set the function switch to the **10A/HZ/%** position and insert the red test lead banana plug into the **10A** jack.
5. Press the **MODE** button to indicate "**DC**" on the display.
6. Remove power from the circuit under test, then open up the circuit at the point where you wish to measure current.
7. Connect the black test probe tip and the red test probe tip in series to the circuit under test.
8. Apply power to the circuit.
9. Read the current on the display.



6.5. AC CURRENT (FREQUENCY, DUTY CYCLE) MEASUREMENTS

CAUTION: Do not make 20A current measurements for longer than 30 seconds. Exceeding 30 seconds may cause damage to the meter and/or the test leads.

1. Insert the black test lead banana plug into the negative **COM** jack.
2. For current measurements up to 5000 μ A AC, set the function switch to the yellow **μ A** position and insert the red test lead banana plug into the **μ A/mA** jack.
3. For current measurements up to 500mA AC, set the function switch to the **mA** position and insert the red test lead banana plug into the **μ A/mA** jack.
4. For current measurements up to 20A AC, set the function switch to the yellow **10A/HZ/%** position and insert the red test lead banana plug into the **10A** jack.
5. Press the **MODE** button to indicate "AC" on the display.
6. Remove power from the circuit under test, then open up the circuit at the point where you wish to measure current.
7. Connect the black test probe tip and the red test probe tip in series to the circuit under test.
8. Apply power to the circuit.
9. Read the current on the display.
10. In the 10A and mA function, press the **MODE** button to indicate "Hz(%)".
11. Read the frequency on the main display and the duty on the auxiliary display.



6.6. RESISTANCE MEASUREMENTS

WARNING: To avoid electric shock, disconnect power to the unit under test and discharge all capacitors before taking any resistance measurements. Remove the batteries and unplug the line cords.

1. Set the function switch to the  position.
2. Insert the black test lead banana plug into the negative **COM** jack. Insert the red test lead banana plug into the positive Ω jack.
3. Press the **MODE** button to indicate " Ω " on the display.
4. Touch the test probe tips across the circuit or part under test. It is best to disconnect one side of the part under test so the rest of the circuit will not interfere with the resistance reading.
5. Read the resistance on the display.





6.7. CONTINUITY CHECK

WARNING: To avoid electric shock, never measure continuity on circuits or wires that have voltage on them.

1. Set the function switch to the  position.
2. Insert the black lead banana plug into the negative **COM** jack. Insert the red test lead banana plug into the positive Ω jack.
3. Press the **MODE** button to indicate " \bullet)])" and " Ω " on the display.
4. Touch the test probe tips to the circuit or wire you wish to check.
5. If the resistance is less than approximately 50Ω , the audible signal will sound. If the circuit is open, the display will indicate "**OL**".

6.8. DIODE TEST

1. Set the function switch to the  position.
2. Insert the black test lead banana plug into the negative **COM** jack and the red test lead banana plug into the positive Ω jack.
3. Press the **MODE** button to indicate "" and "**V**" on the display.
4. Touch the test probes to the diode under test. Forward voltage will typically indicate 0.400 to 0.700V. Reverse voltage will indicate "**OL**". Shorted devices will indicate near 0V and an open device will indicate "**OL**" in both polarities.



6.9. CAPACITANCE MEASUREMENTS

WARNING: To avoid electric shock, disconnect power to the unit under test and discharge all capacitors before taking any capacitance measurements. Remove the batteries and unplug the line cords.

1. Set the rotary function switch to the  position.
2. Insert the black test lead banana plug into the negative **COM** jack.
3. Insert the red test lead banana plug into the positive **V** jack.
4. Press the **MODE** button to indicate "**F**" on the display.
5. Touch the test leads to the capacitor to be tested. Read the capacitance value on the display.



6.10. TEMPERATURE MEASUREMENTS

1. Set the function switch to the Temp position.
2. Insert the Temperature Probe into the input jacks, making sure to observe the correct polarity.
3. Press the **MODE** button to indicate "°C" or "°F"
4. Touch the Temperature Probe head to the part whose temperature you wish to measure. Keep the probe touching the part under test until the reading stabilizes (about 30 seconds).
5. Read the temperature on the display.

Note: The temperature probe is fitted with a type K mini connector. A mini connector to banana connector adaptor is supplied for connection to the input banana jacks.



6.11. FREQUENCY (DUTY CYCLE) MEASUREMENTS (ELECTRONIC)

1. Set the rotary function switch to the **Hz/%** position.
2. Insert the black lead banana plug into the negative **COM** jack and the red test lead banana plug into the positive **Hz** jack.
3. Touch the test probe tips to the circuit under test.
4. Read the frequency on the display.
5. Press the **MODE** button to indicate "%".
6. Read the % duty cycle on the display.



6.12. INSULATION RESISTANCE MEASUREMENTS

1. Set the rotary function switch to the **INSULATION** position ,and Press the **RANGE** button to chose one of the voltage which display on the left .
2. Connect two testing lines to the tested.
3. Push down and hold the "**TEST**" button to be test. If there is voltage (AC/DC) over 30V, the insulation test will not work. If there is no voltage or charge and the voltage is lower than 30V, the insulation test will proceed and the voltage injected will be on the primary display, the insulation resistance in $M\Omega$ is indicated in-phase with analog bar; on the auxiliary display, the tested insulation voltage in V (DC) is indicated, the symbol " \triangle " flashes and the buzzer beeps frequently
4. Releasing the "TEST" button or pushing down the "TEST" button in the "LOCK " status will exit from the "LOCK" status and stop the insulation test.
5. The meter will subsequently discharge the balance insulation voltage of the tested through the inner switch of the meter.

6.13. POWER TOOLS AND SMALL APPLIANCES

This test would also apply to other similar equipment that has a line cord. For double insulated power tools, the megohmmeter lead shown connected to the housing would be connected to some metal part of the tool (e.g. chuck, blade).

Note:The switch of the device must be in the "ON"position and the main power should be disconnected.

MOTORS

AC-Disconnect the motor from the line by disconnecting the wires at the motor terminals or by opening the main switch. If the main switch is used and the motor also has a starter then the starter must be held, by some means, in the "ON" position. In the latter case, the measured resistance will include the resistance of the motor, wire and all other components between the motor and the main switch. If Low Ohms is indicated, the motor and other components should be checked individually. If the motor is disconnected at the motor terminals, connect one megohmmeter lead to the grounded motor housing and the other lead to One of the motor leads. DC-Disconnect the motor from the line. To test the brush rigging, field coils and armature connect one megohmmeter lead to the grounded motor housing and the other lead to the brush on the commutator. If the resistance measurement indicates a low reading, raise the brushes off the commutator and separately test the armature, field coils and brush

rigging by connecting one megohmmeter lead to each of them individually, leaving the other connected to the grounded motor housing. The above also applies to DC Generators.

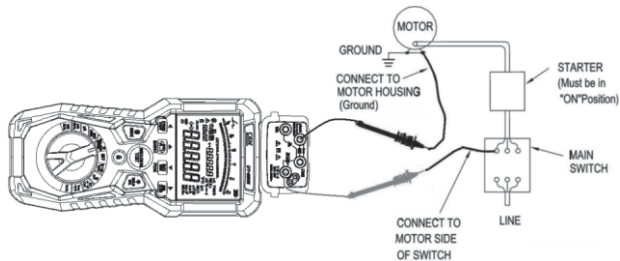

CABLES

Disconnect the cable from the line. Also disconnect opposite end to avoid errors due to leakage from other equipment. Check each conductor to ground and /or lead sheath by connecting one megohmmeter lead to a ground and /or lead sheath and the other megohmmeter lead to each of the conductors in turn. Check insulation resistance between conductors by connecting megohmmeter leads to conductors in pairs.

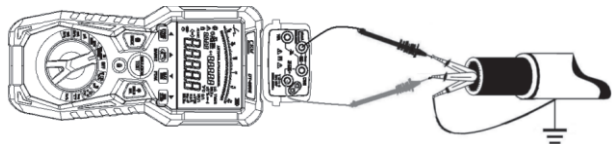

6.14. DAR AND PI INSULATION TESTS

DAR and PI tests are measurements of resistance over time expressed as a ratio of resistance at time t_2 divided by resistance at time t_1 . The assumption is that insulation temperature does not vary widely over the duration of the test so the resulting DAR and/or PI value are temperature independent. Testing should be done at or below 40°C, 104°F for this assumption to hold.

1. Set the rotary function to the **INSULATION** position.
2. Press the **MODE** button to select the voltage (50/100/250/500/1000V)
3. Press the **T-PI-DAR** button to select **PI**, **DAR** or **t**, when the **PI OR**

DAR is selected, the lock function will be active.

4. Connect the two testing line to be tested.
5. When the **PI OR DAR** functional test is complete, the instrument will automatically exit the test and display the result on the left side of the LCD display.

DAR = IR60s/IR15s



| Insulation Condition | DAR Result |
|-----------------------------|-------------------|
| Poor | <1 |
| Acceptable | 1 - 1.4 |
| Excellent | 1.4 - 1.6 |

PI = IR 10min/IR 1 min

| Insulation Condition | PI Result |
|-----------------------------|------------------|
| Poor | <1 |
| Questionable | 1 - 2 |
| Acceptable | 2 - 4 |
| Excellent | <4 |

6.15. MODE/BLUETOOTH

Press the **MODE**  button to select AC or DC, Frequency or Duty Cycle, Resistance, Continuity or Diode Test and °C or °F.

Bluetooth® allows readings to be displayed and stored on mobile devices. To activate Bluetooth®, press and hold the **MODE**  button until the "📶" symbol appears on the LCD display. Bluetooth® should be disabled when not connected to a mobile device in order to conserve battery power. To turn off Bluetooth®, press and hold the **MODE**  button until the "📶" symbol no longer appears on the display.

Note: Bluetooth Connect:

1. Turn on the Bluetooth function on the instrument using Menu Button
2. Turn on the Bluetooth of the Smartphone, press the **Meterbox Pro** icon and enter into the home interface. Then press **Connect Device** icon on the home interface, Bluetooth device name will appear.
3. Touch the device name listed in Bluetooth devices list to connect the meter.

Detailed information about **Meterbox Pro** available on the APP help file.

Meterbox Pro for Android: Please search in Google Play with keyword Meterbox Pro, download and run.

Meterbox Pro for iOS: Please search in the Apple Store with keyword Meterbox Pro, download and run.

7. AUTORANGING/MANUAL RANGE SELECTION

When the meter is first turned on, it automatically goes into AutoRanging. This automatically selects the best range for the measurements being made and is generally the best mode for most measurements. For measurement situations requiring that a range be manually selected, perform the following:

1. Press the **RANGE** key. The "AUTO" display indicator will turn off.
2. Press the **RANGE** key to step through the available ranges until you select the range you want.
3. To exit the Manual Ranging mode and return to Autoranging, press and hold RANGE button.

7.1. MAX/MIN



1. Press the **MAX/MIN** key to activate the MAX/MIN recording mode. The display icon "**MAX**" will appear. The meter auxiliary display will display and hold the maximum reading and will update only when a new "max" occurs at the same time the minimum values are calculated as well, press the **MAX/MIN** button to alternately display the maximum or minimum values.
2. To exit MAX/MIN mode press **and hold** the **MAX/MIN** button for about two seconds.

7.2. RELATIVE MODE

The relative measurement feature allows you to make measurements relative to a stored reference value. A reference voltage, current, etc. can be stored and measurements made in comparison to that value. The displayed value is the difference between the reference value and the measured value. **Note:** Relative mode operated in the Rlow function is zero.

1. Perform the measurement as described in the operating instructions.
2. Press the **REL** button to store the reading in the display and the "REL" indicator will appear on the display.
3. The auxiliary display show **REL TEST** value and Main display show the current value.
4. Press the **REL** button to exit the relative mode.

7.3. DISPLAY BACKLIGHT

Press the  button to turn the backlight on or off. The backlight will automatically turn off after 30 SECONDS. Press and hold the  button to switch backlight mode.

7.4. HOLD

The hold function freezes the reading in the display. Press the **HOLD** key momentarily to activate or to exit the **HOLD** function.

7.5. PEAK HOLD

The Peak Hold function captures the peak voltage or current. The meter can capture negative or positive peaks as fast as 1 millisecond in duration. Press and hold for about two seconds the **PEAK** button, "**PEAK**" and "**MAX**" will display. Press it again, "**MIN**" will display but "**MAX**" will disappear. The meter will update the display each time a lower negative peak and a higher positive **voltage** occurs. **Press and hold the button to exit the PEAK HOLD mode.** Auto Power Off feature will be disabled automatically in this mode.

7.6. DATA RECORD (STORE/RECALL)

1. LOG/VIEW function

In the normal testing mode, press and hold STORE/VIEW button for about two seconds into STORE OR VIEW function sequence, such as, manual LOG->TIME SET FOR auto LOG->auto LOG->VIEW
IN manual LOG function, press the STORE/VIEW button once to store one data.

2. IN TIME SET function

Press the ▲ button once can increase the recording interval, press the ▼ button once to decrease the recording interval. In auto LOG function, press the STORE/VIEW button once to active au to LOG function, at the same time, "LOG A" flashes, press it once again to s top auto log.

3. IN VIEW function

Press the ▲ button once to view next data, press the ▼ button once to view last data press the  button once to delete all the log data.

7.7. LOW BATTERY INDICATION

When the  icon flashes in the display, the battery should be replaced.

8. MAINTENANCE

WARNING: To avoid electric shock, disconnect the test leads from any source of voltage before removing the back cover or the battery or fuse covers.

WARNING: To avoid electric shock, do not operate your meter until the battery and fuse covers are in place and fastened securely.

This MultiMeter is designed to provide years of dependable service, if the following care instructions are performed:

1. **KEEP THE METER DRY.** If it gets wet, wipe it off.
2. **USE AND STORE THE METER IN NORMAL TEMPERATURES.** Temperature extremes can shorten the life of the electronic parts and distort or melt plastic parts.
3. **HANDLE THE METER GENTLY AND CAREFULLY.** Dropping it can damage the electronic parts or the case.
4. **KEEP THE METER CLEAN.** Wipe the case occasionally with a damp cloth. DO NOT use chemicals, cleaning solvents, or detergents.
5. **USE ONLY FRESH BATTERIES OF THE RECOMMENDED SIZE AND TYPE.** Remove old or weak batteries so they do not leak and damage the unit.

8.1. BATTERY INSTALLATION

WARNING: To avoid electric shock, disconnect the test leads from any source of voltage before removing the battery cover.

1. Turn power off and disconnect the test leads from the meter.
2. Open the rear battery cover by removing two screws (B) using a Phillips head screwdriver.
3. Insert the battery into the battery holder, observing the correct polarity.
4. Put the battery cover back in place. Secure with the screws.

WARNING: To avoid electric shock, do not operate the meter until the battery cover is in place and fastened securely.

NOTE: If your meter does not work properly, check the fuses and batteries to make sure that they are still good and that they are properly inserted.

8.2. REPLACING THE FUSES

WARNING: To avoid electric shock, disconnect the test leads from any source of voltage before removing the meter cover.

1. Disconnect the test leads from the meter.
2. Remove the battery cover (two "B" screws) and the battery.
3. Remove the six "A" screws securing the rear cover.
4. Gently remove the old fuse and install the new fuse into the holder.
5. Always use a fuse of the proper size and value (0.5A/1000V fast blow for the 400mA range [SIBA 70-172-40], 10A/1000V fast blow for the 20A range [SIBA 50-199-06]).
6. Replace and secure the rear cover, battery and battery cover.

WARNING: To avoid electric shock, do not operate your meter until the fuse cover is in place and fastened securely.

9. SPECIFICATIONS

9.1. DC VOLTAGE

| Range | Resolution | Accuracy |
|-------|------------|----------------------------|
| 500mV | 0.01mV | ±(0.1% reading + 4 digits) |
| 5V | 0.0001V | |
| 50V | 0.001V | |
| 500V | 0.01V | |
| 1000V | 0.1V | |

9.2. AC VOLTAGE (50 to 1000Hz)

| Range | Resolution | Accuracy |
|-------|------------|----------------------------|
| 500mV | 0.01mV | ±(1.0% reading + 5 digits) |
| 5V | 0.0001V | |
| 50V | 0.001V | |
| 500V | 0.01V | |
| 1000V | 0.1V | |

All AC voltage ranges are specified from 5% of range to 100% of range

NOTE: All AC current ranges are specified from 5% of range to 100% of range. Accuracy is stated at 18°C to 28°C (65°F to 83°F) and less than 75% RH.

Low Pass Filter: 50/60HZ, ±(1%+20)
60-400HZ, ±(3%+20) >3KHZ (-3dB)

AC switch according to the calibration of sine wave. It generally increase ±(2% reading + 2% full scale) if non sine wave in the wave crest less than 3.0.

9.3. DC CURRENT

| Range | Resolution | Accuracy |
|--------------|--------------|---------------------------------|
| 500 μ A | 0.01 μ A | $\pm(1.0\%$ reading + 3 digits) |
| 5000 μ A | 0.1 μ A | |
| 50mA | 0.001mA | |
| 500mA | 0.01mA | |
| 10A | 0.001A | |

9.4. AC CURRENT

| Range | Resolution | Accuracy |
|--------------|--------------|---|
| 500 μ A | 0.01 μ A | $\pm(1.5\%$ reading + 3digits) (50 to1000Hz) |
| 5000 μ A | 0.1 μ A | |
| 50mA | 0.001mA | |
| 500mA | 0.01mA | |
| 10A | 0.001A | |

All AC current ranges are specified from 5% of range to 100% of range

9.5. RESISTANCE

| Range | Resolution | Accuracy |
|---------------|------------------|---------------------------------|
| 500 Ω | 0.01 Ω | $\pm(1\%$ reading + 9 digits) |
| 5k Ω | 0.0001k Ω | $\pm(1\%$ reading + 4 digits) |
| 50k Ω | 0.001k Ω | |
| 500k Ω | 0.01k Ω | |
| 5M Ω | 0.001M Ω | $\pm(2.0\%$ reading + 9 digits) |
| 50M Ω | 0.001M Ω | $\pm(3.0\%$ reading + 9 digits) |

9.6. CAPACITANCE

| Range | Resolution | Accuracy |
|-------------|----------------|----------------------------------|
| 500nF | 0.01nF | $\pm(3.5\%$ reading + 40 digits) |
| 5 μ F | 0.0001 μ F | $\pm(3.5\%$ reading + 9 digits) |
| 50 μ F | 0.001 μ F | |
| 500 μ F | 0.01 μ F | |
| 5.000mF | 0.0001mF | $\pm(5\%$ reading + 9 digits) |

9.7. FREQUENCY (ELECTRONIC)

| Range | Resolution | Accuracy |
|--------|------------|----------------------------|
| 50Hz | 0.001Hz | ±(0.3% reading + 2 digits) |
| 500Hz | 0.01Hz | |
| 5kHz | 0.0001kHz | |
| 50kHz | 0.001kHz | |
| 500kHz | 0.01kHz | |
| 5MHz | 0.0001MHz | |
| 50MHz | 0.001MHz | |

Sensitivity: 0.8V rms min. @ 20% to 80% duty cycle and <100kHz;
5Vrms min @ 20% to 80% duty cycle and >100kHz.

9.8. FREQUENCY (ELECTRICAL)

| Range | Resolution | Accuracy |
|---------------|-------------------|------------------|
| 40.00Hz-10KHz | 0.01Hz - 0.001KHz | ± (0.5% reading) |

Sensitivity: 1Vrms

9.9. DUTY CYCLE

| Range | Resolution | Accuracy |
|----------|------------|---------------------------|
| 5 to 95% | 0.01% | ± (1% reading + 2 digits) |

Pulse width: 100µs - 100ms, Frequency: 5Hz to 150kHz

9.10. TEMPERATURE - K-TYPE

| Range | Resolution | Accuracy |
|---------------|------------|---|
| -50 to 1200°C | 0.1°C | ±(1.0% reading + 2.5°C) |
| -58 to 2192°F | 0.1°F | ±(1.0% reading +4.5°F) (probe accuracy not included) |

9.11. MEG OHMS

| Terminal Voltage | Range | Resolution | Accuracy | Test Current |
|------------------------|---------------|------------|----------|--------------|
| 50V (0%~ +20%) | 0.050~5.000MΩ | 0.001MΩ | ±(2%+10) | 1mA |
| | 5.000~50.00MΩ | 0.01MΩ | ±(3%+10) | @load |
| | 50.00~500.0MΩ | 0.1MΩ | ±(4%+5) | 50kΩ |
| | 500~2000MΩ | 1MΩ | ±(5%+5) | |
| 100V (0%~ +20%) | 0.100~5.000MΩ | 0.001MΩ | ±(2%+10) | 1mA |
| | 5.000~50.00MΩ | 0.01MΩ | ±(3%+10) | @load |
| | 50.00~500.0MΩ | 0.1MΩ | ±(4%+5) | 250kΩ |
| | 500~5000MΩ | 1MΩ | ±(5%+5) | |
| 250V (0%~ +10%) | 0.250~5.000MΩ | 0.001MΩ | ±(2%+10) | 1mA |
| | 5.000~50.00MΩ | 0.01MΩ | ±(3%+10) | @load |
| | 50.00~500.0MΩ | 0.1MΩ | ±(3%+5) | 250kΩ |
| | 500~5000MΩ | 1MΩ | ±(4%+5) | |
| 500V (0%~ +10%) | 0.500~5.000MΩ | 0.001MΩ | ±(2%+10) | 1mA |
| | 5.000~50.00MΩ | 0.01MΩ | ±(3%+10) | @load |
| | 50.00~500.0MΩ | 0.1MΩ | ±(3%+5) | 500KΩ |
| | 500~5000MΩ | 1MΩ | ±(4%+5) | |
| 1000V (0%~ +10%) | 1.000~5.000MΩ | 0.001MΩ | ±(2%+10) | 1mA |
| | 5.000~50.00MΩ | 0.01MΩ | ±(3%+10) | @load |
| | 50.00~500.0MΩ | 0.1MΩ | ±(4%+5) | 1MΩ |
| | 500~5000MΩ | 1MΩ | ±(5%+5) | |

9.12. LOW OHMS

| Range | Resolution | Accuracy | Open Circuit Voltage | Overload Protection |
|--------------|------------|------------|----------------------|---------------------|
| 0.000~5.000Ω | 0.001Ω | ±(1.5%+30) | 5.0±1V | 250V RMS |
| 5.00~50.00Ω | 0.01Ω | ±(2.0%+5) | | |
| 50.0~500.0Ω | 0.1Ω | ±(2.5%+5) | | |
| 500~2000Ω | 1Ω | ±(3.0%+5) | | |

Note: Accuracy specifications consist of two elements:

- (% reading) – This is the accuracy of the measurement circuit.
- (+ digits) – This is the accuracy of the analogue to digital converter.

9.13. GENERAL SPECIFICATIONS

| Function | Range |
|---------------------------|---|
| Enclosure | Double molded, waterproof IP65 |
| Shock (Drop Test) | 3.2 feet (1 meters) |
| Diode Test | Test current of 0.9mA maximum, open circuit voltage 2.8V DC typical |
| Continuity Check | Audible signal will sound if the resistance is less than 50Ω (approx.), test current <0.35mA |
| PEAK | Captures peaks >1ms |
| Temperature Sensor | Requires type K thermocouple |
| Input Impedance | >10MΩ VDC & >9MΩ VAC |
| AC Response | True RMS |
| AC True RMS | The term stands for "Root-Mean-Square," which represents the method of calculation of the voltage or current value. Average responding multimeters are calibrated to read correctly only on sine waves and they will read inaccurately on non-sine wave or distorted signals. True RMS meters read accurately on either type of signal. |
| ACV Bandwidth | 50Hz to 1000Hz |
| Crest Factor | ≤3 at full scale up to 500V, decreasing linearly to ≤1.5 at 1000V |
| Display | 50,000 count backlit liquid crystal with bargraph |
| Overrange indication | "OL" is displayed |
| Auto Power Off | 15 minutes (approximately) with disable feature |
| Polarity | Automatic (no indication for positive); Minus (-) sign for negative |
| Measurement Rate | 3 times per second, nominal |
| Low Battery Indication | "  " flashes if battery voltage drops below operating voltage |
| Battery | 6 x AA NEDA 15A IEC LR6 |
| Fuses | mA, μA ranges; 0.5A/1000V ceramic fast blow A range; 10A/1000V ceramic fast blow |
| Operating Temperature | 5°C to 40°C (41°F to 104°F) |
| Storage Temperature | -20°C to 60°C (-4°F to 140°F) |
| Operating Humidity | Max 80% up to 31°C (87°F) decreasing linearly to 50% at 40°C (104°F) |
| Storage Humidity | <80% |
| Operating Altitude Safety | 7000ft. (2000 meters) maximum. This meter is intended for origin of installation use and protected, against the users, by double insulation per EN61010-1 and IEC61010-1 2nd Edition (2001) to Category IV 600V and Category III 1000V; Pollution Degree 2. The meter also meets UL 61010-1, 2nd Edition (2004), CAN/CSA C22.2 No. 61010-1 2nd Edition (2004), and UL 61010B-2-031, 1st Edition (2003) |



MAJOR TECH (PTY) LTD

South Africa

 www.major-tech.com

 sales@major-tech.com

Australia

 www.majortech.com.au

 info@majortech.com.au

