

USR-DR302 User Manual

File Version: V1.0.0



Contents

1.	Quick Start	4
1.1.	Hardware Testing Environment	5
1.1.1.	Hardware Prepare	5
1.1.2.	Hardware Connection	6
1.2.	Network Test Environment	6
1.3.	Default Parameter	7
1.4.	Data Transmission Test	7
2.	Overview	9
2.1.	Brief Introduction	9
2.2.	Features	9
2.3.	Basic Parameter	10
3.	Hardware Parameters	11
4.	Product Function	12
4.1.	Network Basic Function	12
4.1.1.	Static IP/DHCP/Subnet Masks/Gateway	12
4.1.2.	DNS Server Address	13
4.1.3.	Webserver	14
4.1.4.	Restore to Factory Set	15
4.1.5.	Firmware Upgrade	15
4.2.	Socket Communication	16
4.2.1.	TCP Client Mode	18
4.2.2.	TCP Server Mode	20
4.2.3.	UDP Client Mode	23
4.2.4.	UDP Server Mode	25
4.2.5.	HTTPD Client	26
4.3.	Impersistent Connection	28
4.4.	Clean the buffer data	29
4.5.	USR-VCOM Application	29
4.6.	Modbus Gateway	30
4.7.	USR-Cloud Function	31
4.8.	Other functions	33
4.8.1.	Heartbeat Packet Function	33
4.8.2.	Registration Package Packet Function	34
4.8.3.	Customized Webpage	35
4.8.4.	Link	36
4.8.5.	Index	36
4.8.6.	The number of the client connected	38
4.8.7.	Serial Port Packaging Mechanism	39
4.8.8.	Flow Calculation	39
4.8.9.	Synchronous baud rate (RFC2217)	40
5.	Setting Protocol	42

5.1.	Network Setting Protocol.....	42
5.1.1.	Set Parameter Process	42
5.1.2.	Setting Command Content	43
5.1.3.	Commands' Return Content	48
5.1.4.	Listening Report Method	50
5.2.	Serial Setting Protocol.....	50
5.2.1.	AT Command Overview.....	50
5.2.2.	Error Code	52
5.2.3.	AT Command	52
6.	Parameter Configuration	54
6.1.	Software Configuration.....	54
6.2.	Webpage Configuration.....	56
6.3	AT Command Details.....	58
7.	Contact	70
8.	Disclaimer	70
9.	Update History.....	70

1. Quick Start

Module USR-DR302 is used to realize data transparent transmission between Ethernet interface and the serial port and the protocol converter. The serial port is the RS485 data and in the Ethernet interface, it is the net data package. Users can configure the parameters via the webpage or set-up software, set one time and save forever

The character is aimed at USR-DR302 quick introduce. The users are recommend to operating one time according to this character, and will have a system realize to the N520. Also you can choose the character which you are interested in. As to the details, please refer to the later characters.

Product link:

<https://www.usriot.com/products/din-rail-rs485-serial-to-ethernet-converter.html>

Related software:

Setup software: <https://www.usriot.com/support/downloads/usr-m0-setup-software-v224288.html>

Test software: <https://www.usriot.com/support/downloads/usr-tcp-test-testing-software.html>

Any question during testing, please submit it on our technical support center: <http://h.usriot.com>



USR-DR302

DIN-rail RS485 Serial to Ethernet Converter

USR-DR302 Modbus RS485 to Ethernet converter can realize bidirectional transparent transmission between RS485 and Ethernet. Via web-page or software, rs485 to Ethernet Converter can realize serial data and TCP/IP data package transparent transmission.

- RS485 Port, Industrial Grade
- Standard DIN-rail mounting
- Modbus RTU to Modbus TCP

Certifications



GET A QUOTE

BUY NOW

General Details

Specifications

Downloads

How to Buy

Models

Diagram 1-1 Product Webpage

1.1. Hardware Testing Environment

1.1.1. Hardware Prepare

- DC5V 1A power adapter*1
- USB to 485 cable *1
- Network cable *1
- USR-DR302*1
- PC*1



Diagram 1.1.1-1 Hardware Prepare

1. Testing Aim

- Have a quick recognize to the DR302 and have a basic recognition
- Testing is there is any issue in the product.

2. Data Direction

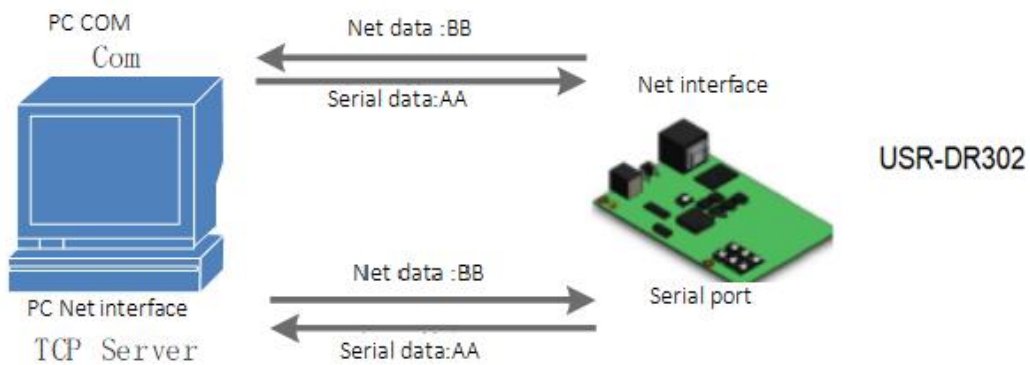

Diagram 1.1.1-2 Data Direction

1.1.2. Hardware Connection



Diagram 1.1.2-1 Hardware Connection

USR-DR302 connects to PC by serial port and RJ45 Port. Then power on USR-DR302 with our AC adapter. The above picture will show you the connection.

Notes:

- Power adapter (5V) and connection cable are provided by USR IOT.
- RS485 is involved.
- PCs in above picture is the same one.

1.2. Network Test Environment

Please check PC setting after hardware connection.

- 1) Disable PC Firewall and anti-virus software.
- 2) Disable the network card nothing to do with testing and just leave one local connection.
- 3) As for USR-DR302 connect with PC directly, should set static IP for PC, which in the same network segment with USR-DR302, like 192.168.0.201.

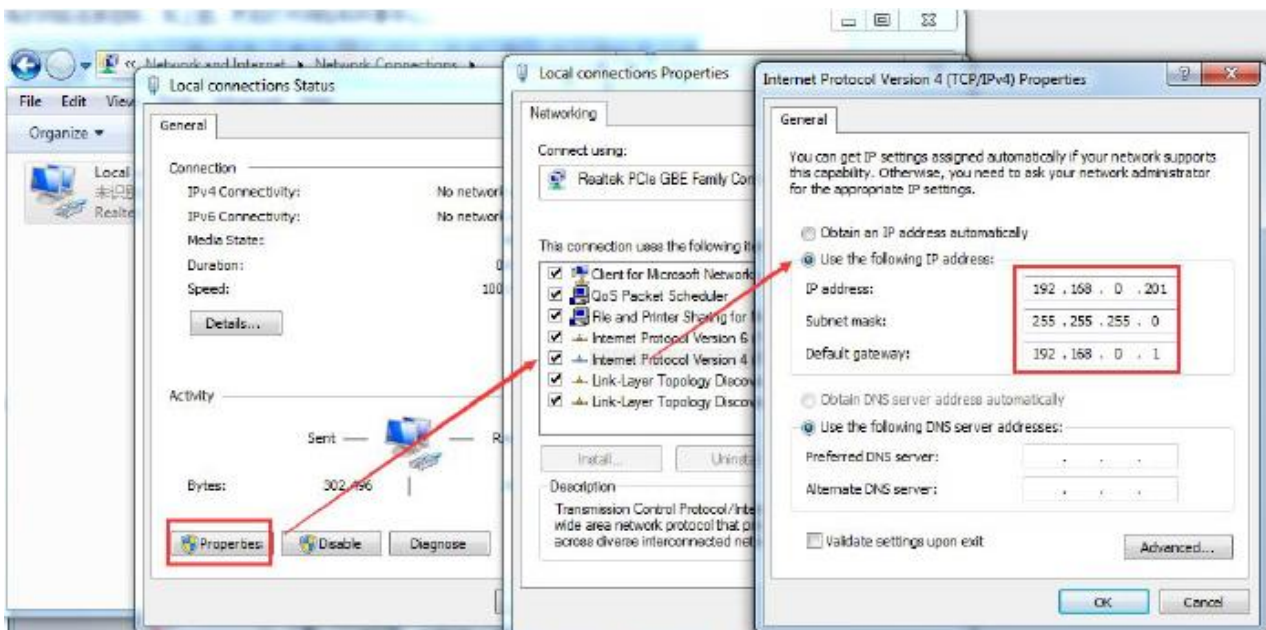

Diagram 1.2-1 PC Local Connection Configuration

1.3. Default Parameter

Default parameter is as below:

Item	Content
User name	admin
Password	admin
IP address	192.168.0.7
Subnet mask	255.255.255.0
Default gateway	192.168.0.1
Default work mode of port	TCP Client
Default remote port	8324
Default local port of port	0
Remote IP address	192.168.0.201
Baud Rate	115200
Parity bit/Data bit/Stop bit	None/8/1

Form 1.3-1 Default Parameters

1.4. Data Transmission Test

Data transmission test is based on the default parameters, please refer to the following steps:

- 1) Open test software "USR-TCP232-Test.exe", and do hardware connection according to Chapter 1.1 Hardware Testing Environment.
- 2) The right side is Network Settings: TCP Server, IP address: 192.168.0.201, port number: 8324, click "Connect" to build TCP connection.
The left side is Serial Settings: Baud Rate: 115200, Parity/Data bit/Stop bit: None/8/1, Click "Open" to enable the COM.

Then we can test data transmission between COM and network.

Data from serial to network is: PC' COM->USR-DR302' COM->USR-DR302 Ethernet port->PC Network;

Data from network to serial is: PC Network->DR302' Ethernet port->DR302 COM-> PC's COM.

The below picture is for your reference:

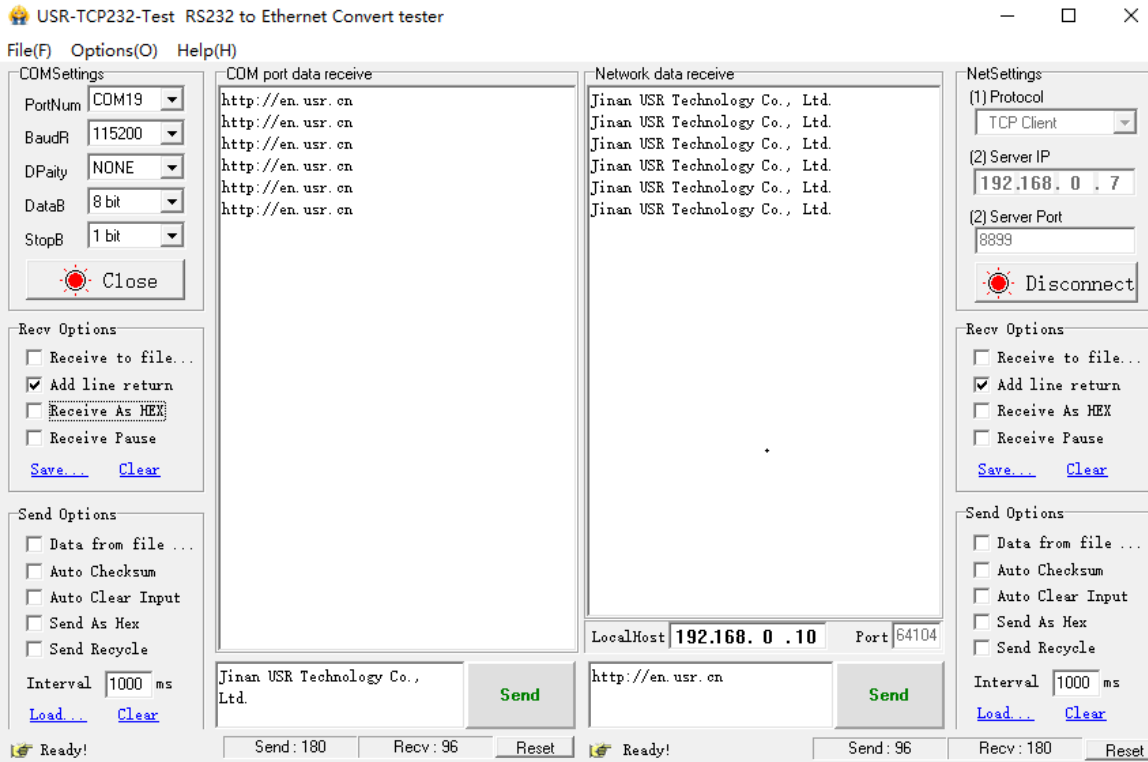

Diagram 1.4-1 Default Parameter Test

2. Overview

2.1. Brief Introduction

USR-DR302 Modbus RS485 to Ethernet converter can realize bidirectional transparent transmission between RS485 and Ethernet. It carries ARM processor, low power, fast speed, high stability. Via web-page or software, rs485 to Ethernet Converter can realize serial data and TCP/IP data package transparent transmission.

2.2. Features

- ARM base on Cortex-M0 kernel, and reliable TCP/IP protocol stack
- Industrial working temperature range from -40C ~85C
- Auto-MDI/MDIX, RJ45 port with 10/100Mbps
- Support TCP server, TCP client, UDP server, UDP client, HTTPD client and modbus TCP work mode
- Serial port baud rate can be set from 600bps to 460.8Kbps, parity: None, Odd, Even, Mark, Space
- Supports self-defined heartbeat package, keep the connection can never crash
- Supports self-defined registration package, check the station of the connection, which also can used as the self-defined package head. Users can use the MAC as the registration package.
- Under the TCP server mode, the number of the client connected to the server can be set from 1-8, default 4. the IP of the client connected can be dispaly. Each connection calculates the data received/transmitted.
- Under the TCP server mode, if the number of the clients number is 8, kick the old one or not can be set.
- Configure the parameters via the webpage, AT command, serial protocol and net protocol, provides setting protocol, and users can put into their software.
- Supports TCP client short connection, the disconnection interval can be set.
- Supports timeout restart(no data and restart), the restart time can be set.
- Before the TCP connection build, client the buffer data or not can be set
- Supports DHCP, obtain the IP automatically.
- The global unique MAC address bought from IEEE, also users can define MAC address
- Supports DNS function, and analyze the domain name. The DNS server address can be set.
- Upgrade firmware via network.
- Support USR-VCOM
- Supports hardware and software restore default settings
- Running across the gateway, converter and the router
- Running in LAN or in access the external net.

2.3. Basic Parameter

Classify	Parameter	Value
Hardware Parameters	Input Voltage	DC5~36V
	Working Current	130mA@5V
	Net interface format	RH45,10/1000Mbps
	Serial baud rate	600~460.8K(bps)
	Serial port	RS485*1
Software parameters	Net protocol	IPV4, TCP/UDP, ARP, ICMP, IPV4
	IP access way	Static IP, DHCP
	DDNS	supports
	User Configuring	Software configuring and webpage configuring AT command
	Transmit way	TCP server, TCP client, UDP server, UDP client
	Similar RFC2217	support
	HTTPD client	support
	TCP server	At most support 8 TCP client to connection
	Net buffer	Send:16Kbyte; receive:4Kbyte
	Serial buffer	receive:1Kbyte
	Average delay	<10ms
	Related software	USR-VCOM, USR-cloud, set-up software
	Packaging mechanism	4 bytes packaging time, 1024 bytes packaging length.
Others	Certification	CE, FCC, ROHS
	Protection	1.5KV electromagnetic isolation
	Dimension	71.0*60.0*25.0mm(L*W*H)
	Operating Temp.	-40~+85°C
	Storage Temp	-40~105°C
	Operating Humidity	5~95%RH
	Storage Humidity	5~95%RH
	Packaging	Electrostatic bubble

Diagram 2.3-1 Basic Parameters

3. Hardware Parameters

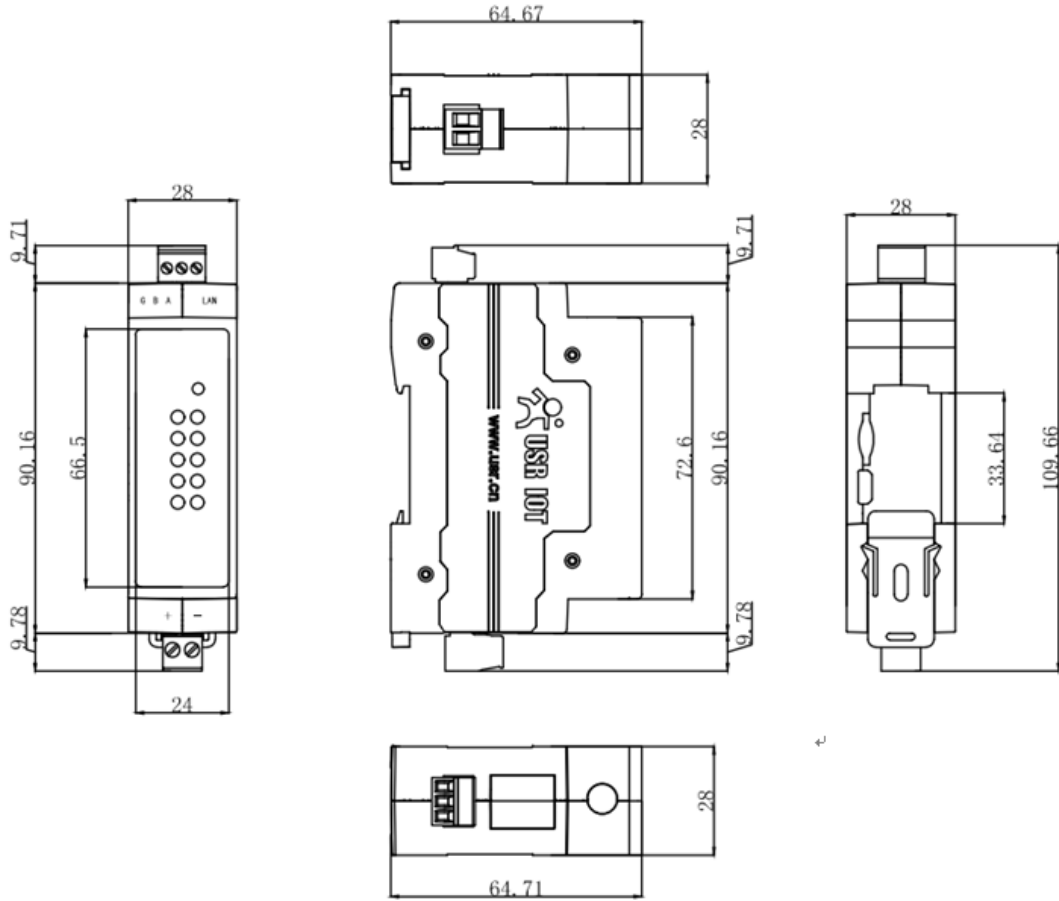

Diagram 3-1 Dimension

4. Product Function

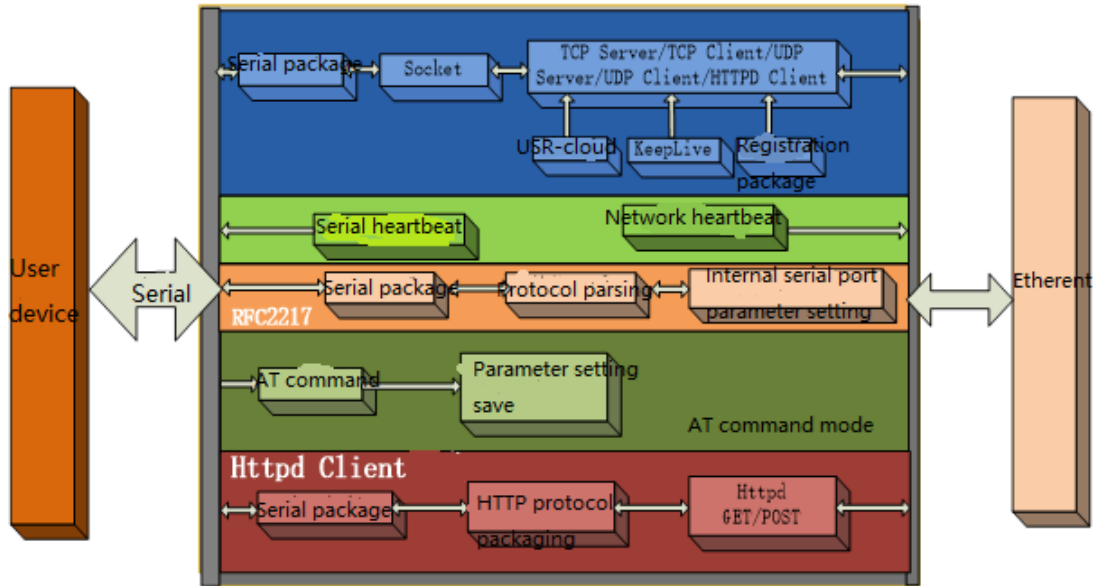

Diagram 4-1 USR-DR302 Function Diagram

4.1. Network Basic Function

4.1.1. Static IP/DHCP/Subnet Masks/Gateway

1. The IP of the module is the symbol in the LAN, which can be distinguish from the other device.

➤ Static IP

Manual setting the static IP, meanwhile please writing the IP, subnet and gateway. Static IP adjust to the scenario that IP and the device correspond.

Advantage: the device access to the IP that can not distribute can searched by the broadcast

Disadvantage: different segment of the different LAN need to configuring.

➤ DHCP

The DHCP is to obtain the IP, gateway and DNS from the gateway automatically to reduce the tedious step for setting the IP. Adjust to the scenario there is no requirement to the IP.

Advantage: communicate directly when access router which can distribute the DHCP to reduce the tedious step to set the IP and the subnet masks.

Disadvantage: access the net without DHCP, just like connect the PC directly, the module can not work normally.

Related AT command:

Command name	Instr
AT+WANN	Setting and query the IP access way, subnet and the gateway parameters of the DR302

Form 4.1.1-1 Related AT Command

2. Subnet masks: to mark which subnet is the host in from the IP address bites and which bites mark the host masks.

3. Gateway: IP address of the router in the LAN, if there is something wrong with the setting, user will can not access the external net. If user do not use the router and so on device, keep default and do not set.

4. Setting software.

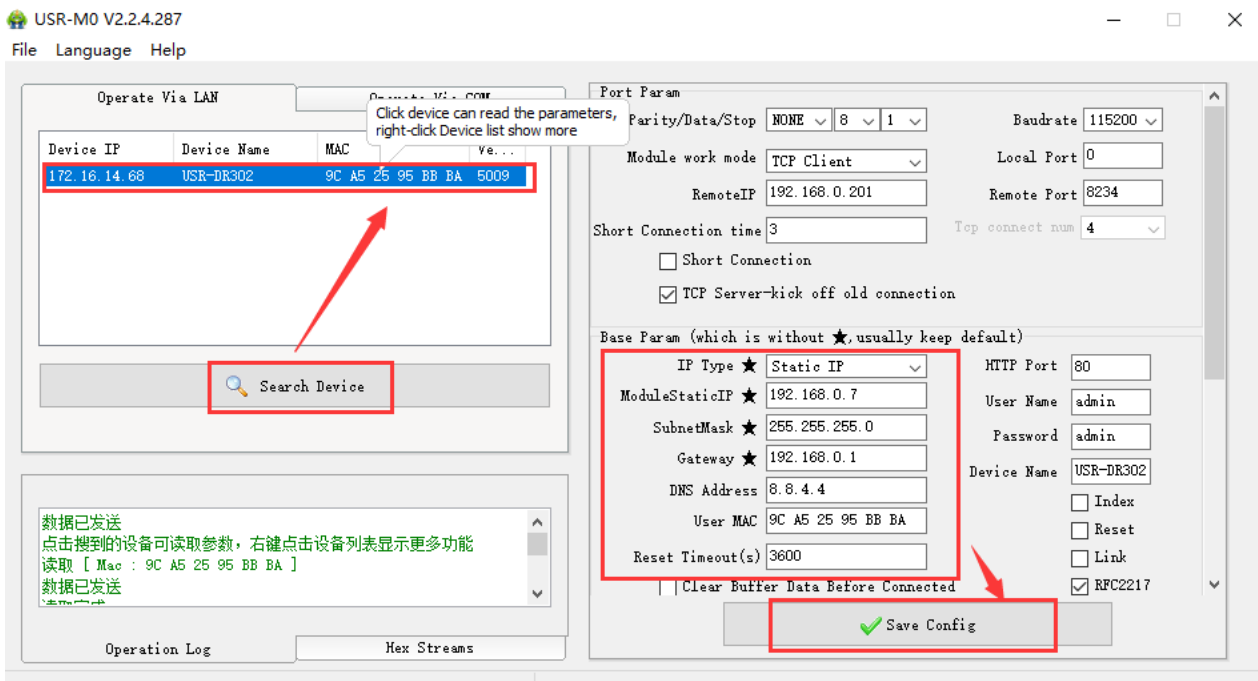

Diagram 4.1.1-1 Setting Software

4.1.2. DNS Server Address

DNS server is used to converter the domain name in to the IP address that net can recognized. The server address of the DR302 can be configured. After setting, all the questing will be sent to this address when the DR302 need to DDNS.

Under the static IP mode, DNS server address default is 8.8.8.8. and under the DHCP mode, DHCP server address can be acquire automatically.

Current Status	parameter
Local IP Config	
Serial Port	
Expand Function	
Misc Config	
Reboot	

IP type :

DNS type :

Static IP : . . .

Submask : . . .

Gateway : . . .

DNS Server : . . .

Diagram 4.1.2-1 Local IP Config

Related AT command:

Command name	Instr
AT+DNS	Setting and query the DNS server address of the DR302

Form 4.1.2-1 Related AT Command

4.1.3. Webserver

DR302 supports build-in webserver, same as the normal webserver. User can setting the parameters via the webpage also can check the related status. Default port of the webserver is 80, and this port can be modified/ after modify, user also can access the build-in webpage to access via the other port.

The default home page is the current state interface, refreshed every 10s, showing DR302 working status:

Total number of data sent by the network: Can judge how much data is sent to the external network.

Total data received by the network: Can determine how much data is sent from the network to the module.

Connected remote IP/network send/receive: Through this item, you can see which device is connected to DR302.

How much data is sent and received by this connection. Currently, only 4 connection status displays are supported.

In UDP Server mode, only the send/receive data is displayed, and the connection IP is not displayed.

 USR -IOT Experts-	Be Honest, Do Best!	
Current Status	Status	Help
Local IP Config	Module Name : USR-DR302 Current IP Address : 192.168.0.7 MAC Address : 9c-a5-25-95-bb-ba TX Count/RX Count : 0/ 0 bytes Remote IP/TX/RX : 0: 192.168.0.201/ 0 byte / 0 byte	<ul style="list-style-type: none"> Current IP Address : default IP of module Remote IP/TX/RX : IP of server or device connecting with module;reset for disconnect TX/RX data volume
Serial Port		
Expand Function		
Misc Config		
Reboot		

Diagram4.1.3-1 Current Status

4.1.4. Restore to Factory Set

1) Hardware restore:

Press the Reload button for 5s to 15s to restore the factory settings. If it is less than 5s or exceeds 15s, the factory reset will not be performed. When the module is configured with incorrect parameters, or if you have forgotten the previously set password, you can restore the factory settings.

2) Software restore:

Restore the factory settings by setup software setting function or send the factory reset command via the network protocol.

3) AT command restore:

Enter the AT command mode, restore via the command.

Related AT command:

Command name	Instr
AT+RELD	Restore to factory setting

Form 4.1.4-1 Related AT Command

4.1.5. Firmware Upgrade

The way to upgrade the DR302 firmware is to upgrade through the network. It is simple and convenient to upgrade the firmware through the network. By upgrading the firmware, you can get more cutting-edge applications. The specific upgrade method is as follows.

1) Upgrade the firmware with a wired network. Before upgrading, turn off the wireless and virtual machine network cards to ensure that the computer only keeps one wired network card. The module and the computer can be connected to the router at the same time or the module can be directly connected to the computer.

2) After the hardware is connected, upgrade the firmware by setup software, do not change the IP and MAC addresses, set the firmware path (it is recommended not to have a Chinese path), and then click to upgrade the firmware.

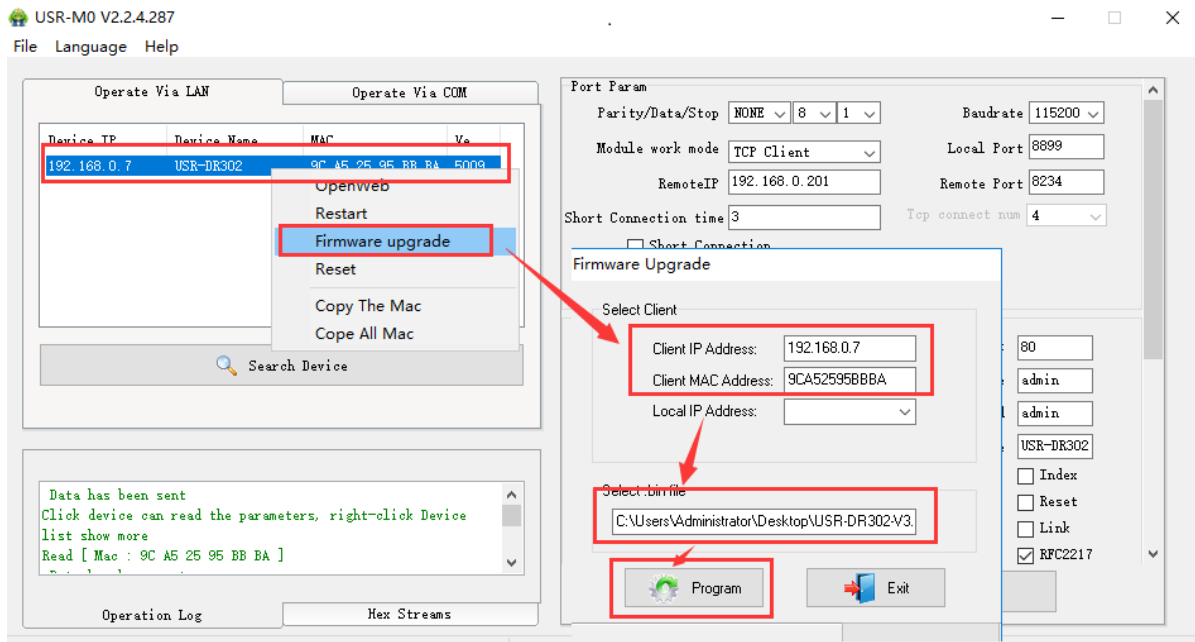

- 3) There is a progress bar during the upgrade. When the progress bar reaches 100%, the setup software will prompt that the upgrade is successful and the upgrade is complete. Re-search the module after the upgrade is complete.

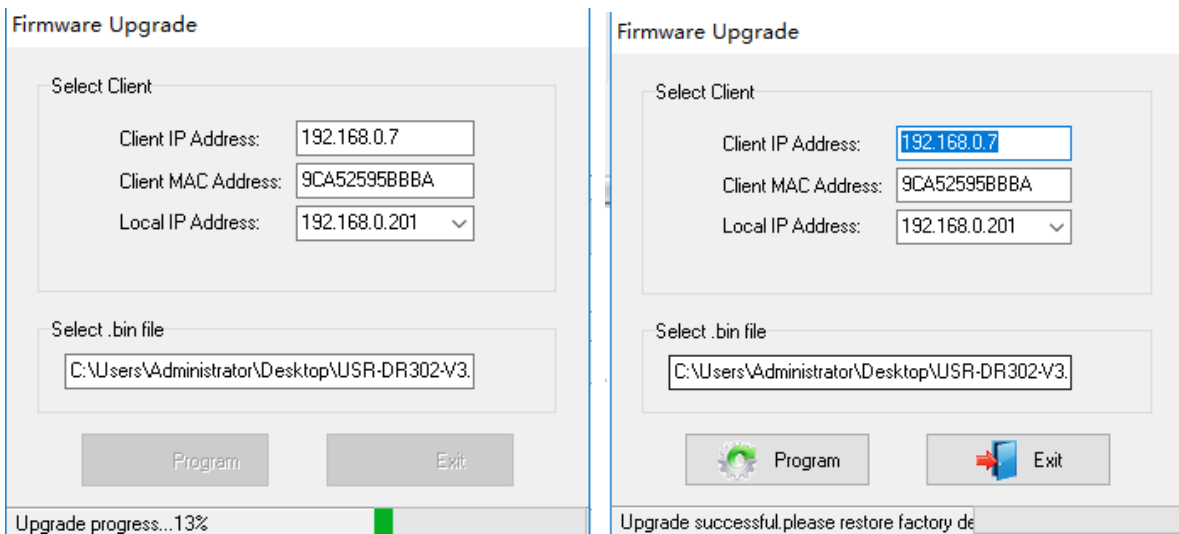

4.2. Socket Communication

There are five work modes for the socket of the DR302: TCP Client, TCP Server, UDP Client, UDP Server, Httpd Client.

Set via the webpage or the set-up software

The webpage are as follows:

Current Status	parameter
Local IP Config	
Serial Port	
Expand Function	
Misc Config	
Reboot	

Baud Rate : bps(600~460.8K)

Data Size : bit

Parity :

Stop Bits : bit

Local Port Number : (0~65535)

Remote Port Number : (1~65535)

Work Mode :

Remote Server Addr :
[192.168.0.201]

RESET :

LINK :

INDEX :

Similar RFC2217 :

USR-M0 V2.2.4.287

File Language Help

Device IP	Device Name	MAC	Ve...
192.168.0.7	USR-DR302	9C A5 25 95 BB BA	5009

Data has been sent
Click device can read the parameters, right-click Device list show more
Read [Mac : 9C A5 25 95 BB BA]

Operation Log Hex Streams

Operate Via LAN Operate Via COM

Parity/Data/Stop Baudrate

Module work mode Local Port

RemoteIP Remote Port

Short Connection time Top connect num

Short Connection

TCP Server-kick off old connection

Base Param (which is without ★, usually keep default)

IP Type ★ HTTP Port

ModuleStaticIP ★ User Name

SubnetMask ★ Password

Gateway ★ Device Name

DNS Address Index

User MAC Reset

Reset Timeout(s) Link

Clear Buffer Data Before Connected RFC2217

Related AT command

Command name	Instr
AT+SOCK	Setup DR302 Socket working mode / target IP / target port

4.2.1. TCP Client Mode

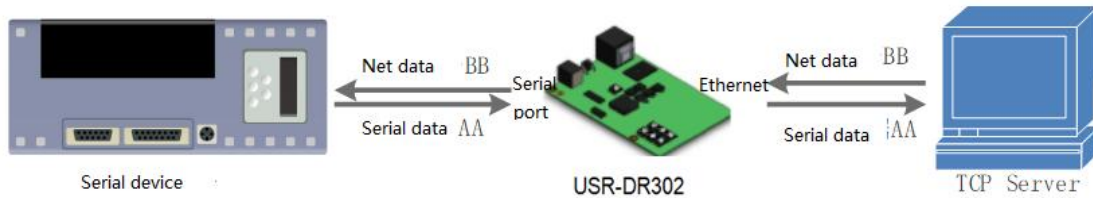

Diagram 4.2.1-1 TCP Client

- 1) TCP client provides the client connection for TCP net server. Query the server automatically can build the connection to realize the data transmission. Different from UDP mode, in this mode, connection has status of disconnection and remaining to make sure the data transmission reliable.
- 2) Identify disconnects. After connection built, it sends keepalive searching packet every 15 seconds. Once there is an interrupt, it can be detected rapidly then make USR-DR302 disconnect from former connection and reconnect.
- 3) Please notice the remote IP/domain name and the remote port when connecting the TCP server. Remote IP can be the device in the same LAN or the device in other LAN. If user want to connect the server across the net, there must be a public IP or the domain name for the server.
- 4) It supports USR Synchronous baud rate (Similar RCF2217), USR-cloud, also supports short connection function.
- 5) Under the same LAN, if 302 is set to static IP, keep the IP and gateway of 302 in the same network segment, and set the gateway IP correctly. Otherwise, communication will not be possible.
- 6) USR-DR302 work as TCP Client, It connects to the target IP/Port automatically, will not accept other connection request.
- 7) When 302 is used as the TCP Client, it is recommended to set the local port number of 302 to 0. In this way, 302 can access the server with a random port number, which can solve the problem of reconnection failure caused by the server determining that the connection state is abnormal.
- 8) Test Example
 - ① Open "USR-TCP232-M0_E45 setup" software.
Set USR-DR302 as TCP Client, Destination IP: 192.168.0.201. Destination port:8234.
Save the parameters and then research again to check if the parameters are correct . Also users can set the work mode ,remote IP and the remote port via the webpage.

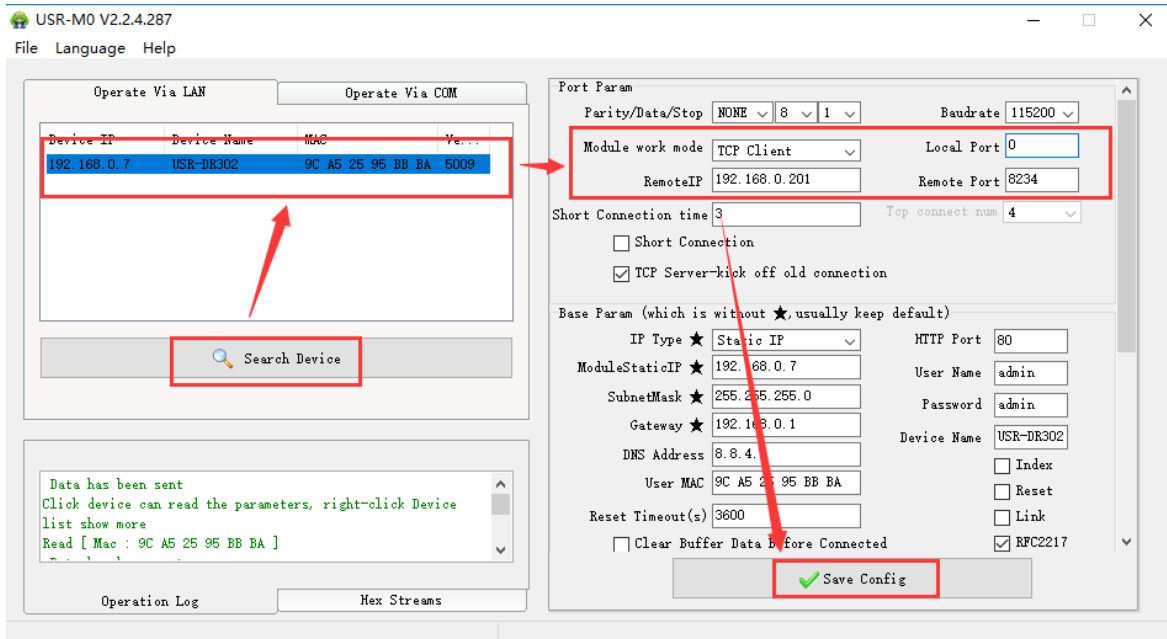

Diagram 4.2.1-2 Configuration

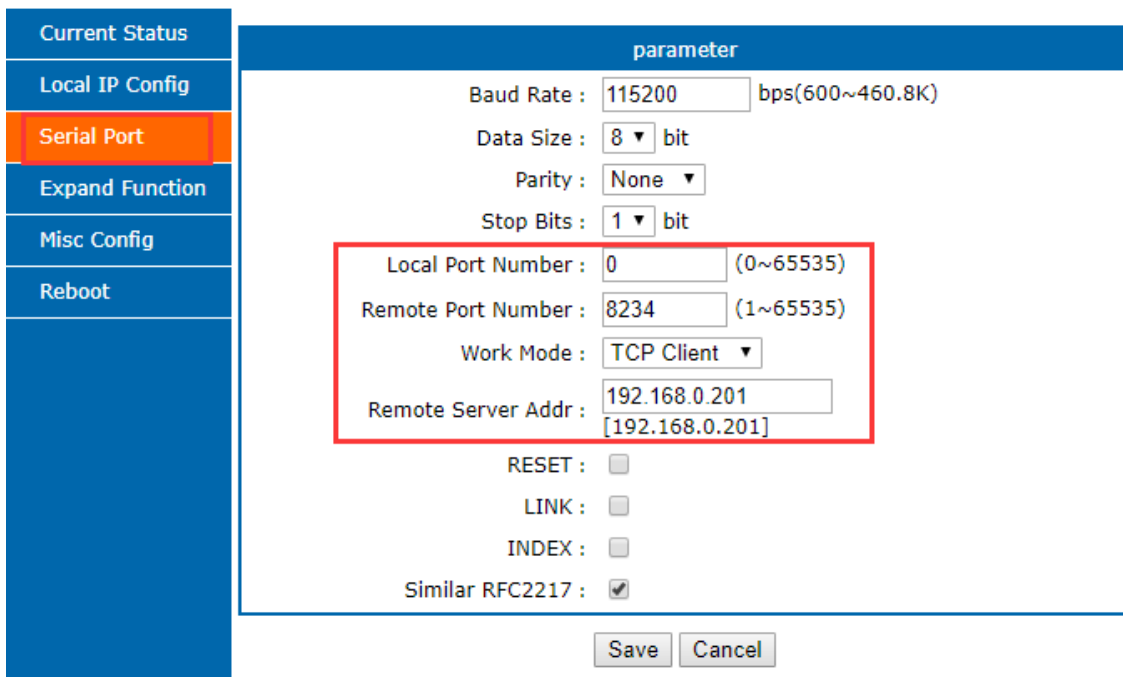

Diagram 4.2.1-3 Serial Port

- ② Open "USR-TCP232-TEST" software:
 Set the USR-TCP232-TEST as TCP Server, its IP: 192.168.0.201, Port number: 8234, Click "Listening"
 Net port display connection information:192.168.0.7:8899(random port distributed). set the right serial port parameters and click to open the serial port.
- ③ Click sent and receive the bi-direction transmitted data

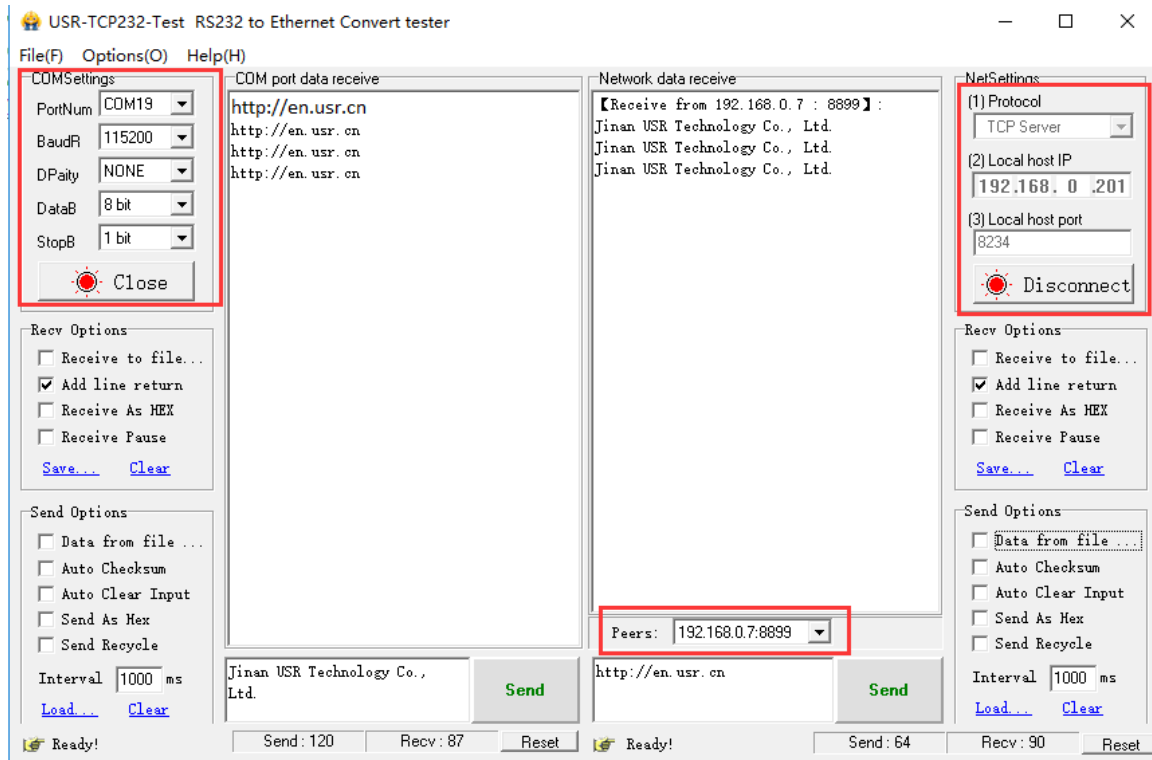

Diagram 4.2.1-4 TCP Client Test

4.2.2. TCP Server Mode

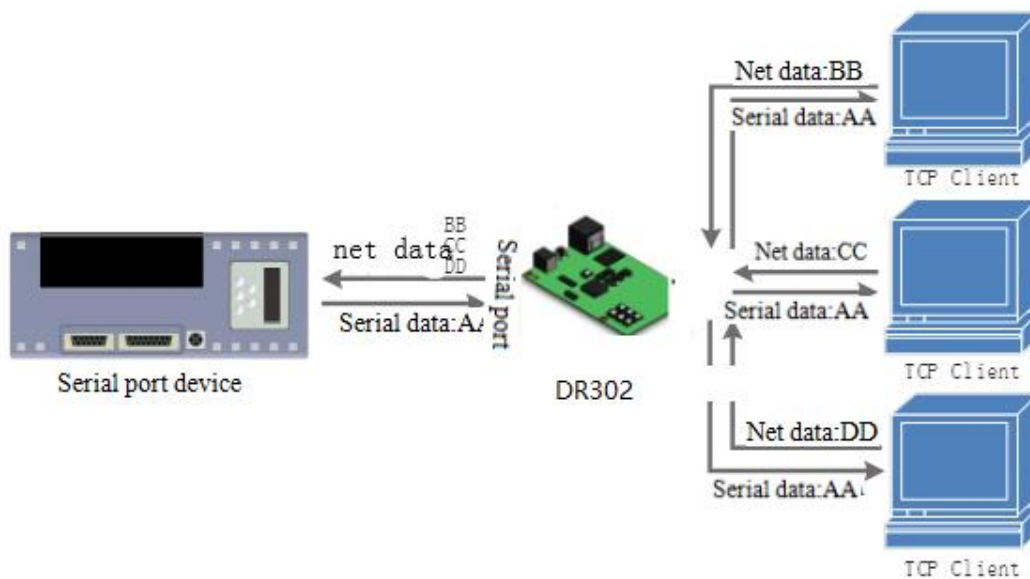
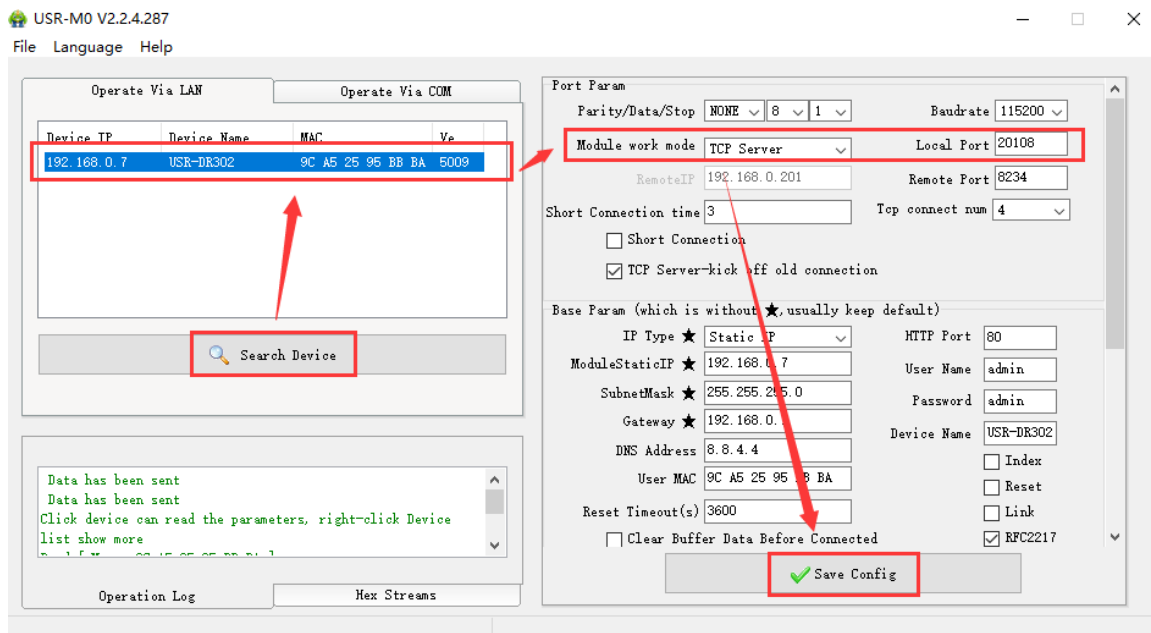

Diagram 4.2.2-1 TCP Server Mode

- 1) DR302 In the TCP Server mode, there is also a KeepAlive function for real-time monitoring of the integrity of the connection.
 - 2) Usually used for communication with TCP clients in the LAN. It is suitable for scenarios where there is no server in the LAN and there are multiple computers or mobile phones requesting data from the server. As with TCP Client, there is a difference between connection and disconnection to ensure reliable exchange of data.
 - 3) This mode supports USR's independent synchronous baud rate function (RFC2217) function.
 - 4) In TCP Server mode, the DR302 actively listens to the local port and responds with a connection request and creates a connection. When the serial port of the DR302 receives the data, it also sends it to all devices that establish a connection with the DR302 server. If you access the DR302's TCP server across the public network, you need to do port mapping on the router.
 - 5) It support 8 clients connections at max. (the number can be set.) the local port is fixed, can not be "0"
 - 6) Under TCP Server mode, when the number of connected clients exceeds the set maximum value, the default is to replace the old connection with a new one, can modify this function in the web page.
 - 7) Test Example
- ① Set USR-DR302 as TCP Server Mode, local port 20108, same as default. Also can set in the webpage.

Diagram 4.2.2-2 TCP server mode (software)

Current Status	parameter
Local IP Config	
Serial Port	
Expand Function	
Misc Config	
Reboot	

Baud Rate : bps(600~460.8K)

Data Size : bit

Parity :

Stop Bits : bit

Local Port Number : (1~65535)

Remote Port Number : (1~65535)

Work Mode :

Remote Server Addr :
[192.168.0.201]

RESET :

LINK :

INDEX :

Similar RFC2217 :

Diagram 4.2.2-3 TCP server mode (webpage)

- ② Open "USR-TCP232-TEST" Software, on the side of NetSettings:
 Protocol: TCP Client
 Server IP/Port: the same value as the default parameter of USR-DR302
 Click "Connect", local host IP is: 192.168.1.201. Set the correct serial port parameters and click to open the serial port.
- ③ Click "Connect" to test data transmission.

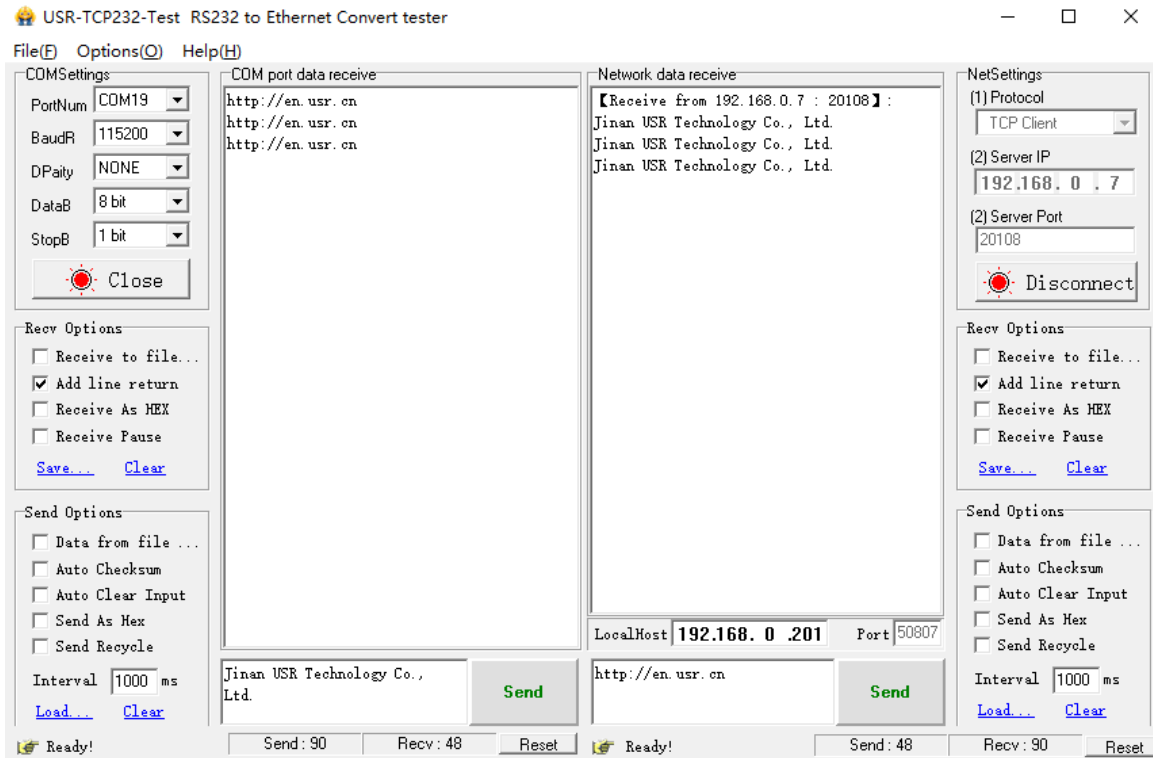

Diagram 4.2.2-2 TCP Server Test

4.2.3. UDP Client Mode

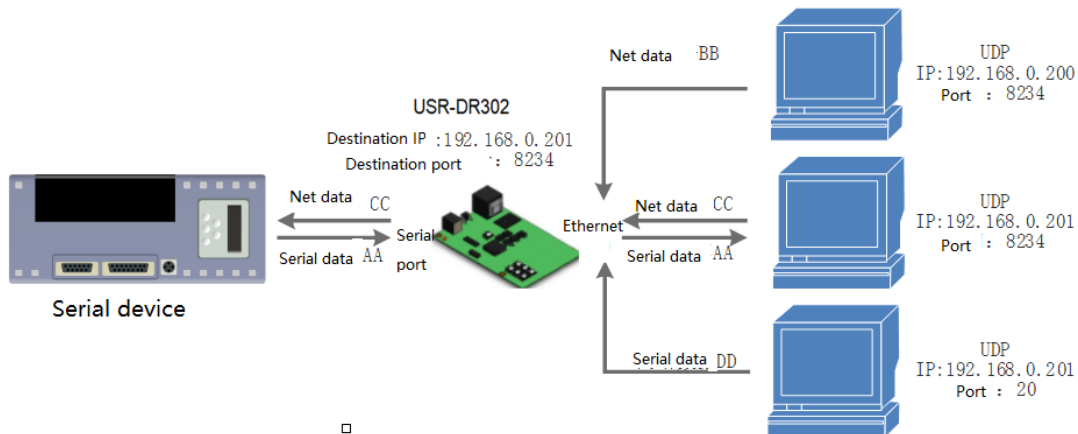

Diagram 4.2.3-1 UDP Client

- 1) It subjects to UDP protocol, no connection, just only sending data. No difference of the connection and disconnection, no requirement with the packet loss, small data package and quick frequency and the data sent to the appointed IP.
- 2) USR-DR302 only communicate with destination port of IP. Otherwise, the data cannot be received.
- 3) Under this mode, destination Address is 255.255.255.255, then it can make UDP broadcast and receive broadcast data. The firmware in the 4015 and later firmware supports the broadcast in the network segment,

such as the broadcast mode of xxx.xxx.xxx.255.

4) Multicast is not supported in UDP mode.

5) Test Example:

- ① Open USR-TCP232-M0, E45 Setup Software: Set DR302 to UDP client mode and the target port is 8234.

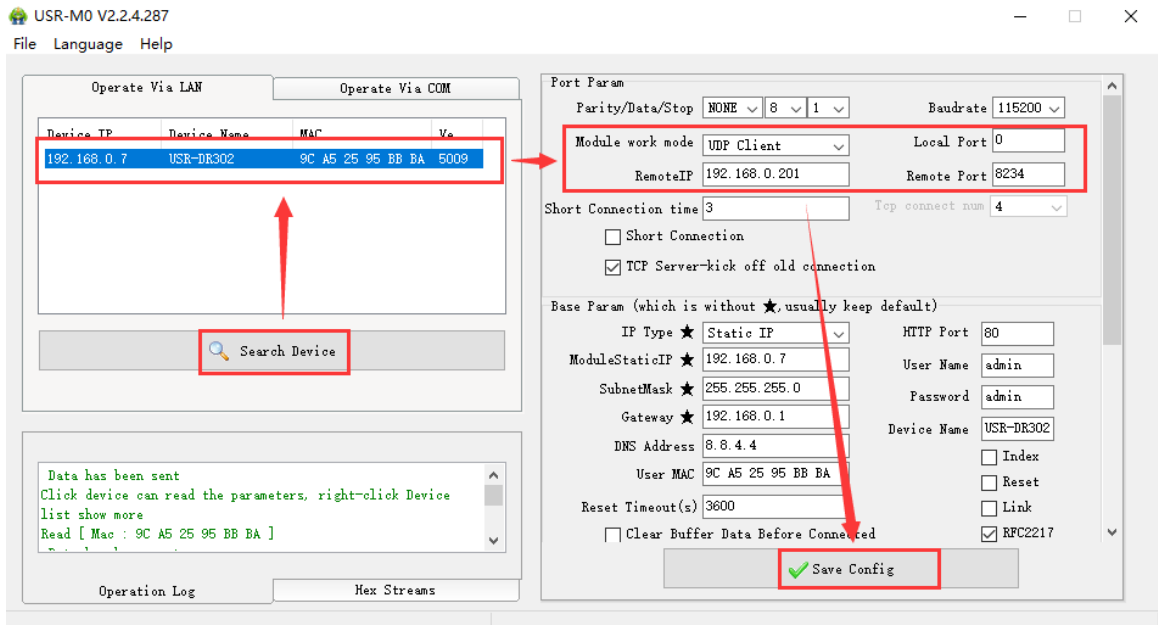

Diagram 4.2.3-2 UDP Client(software)

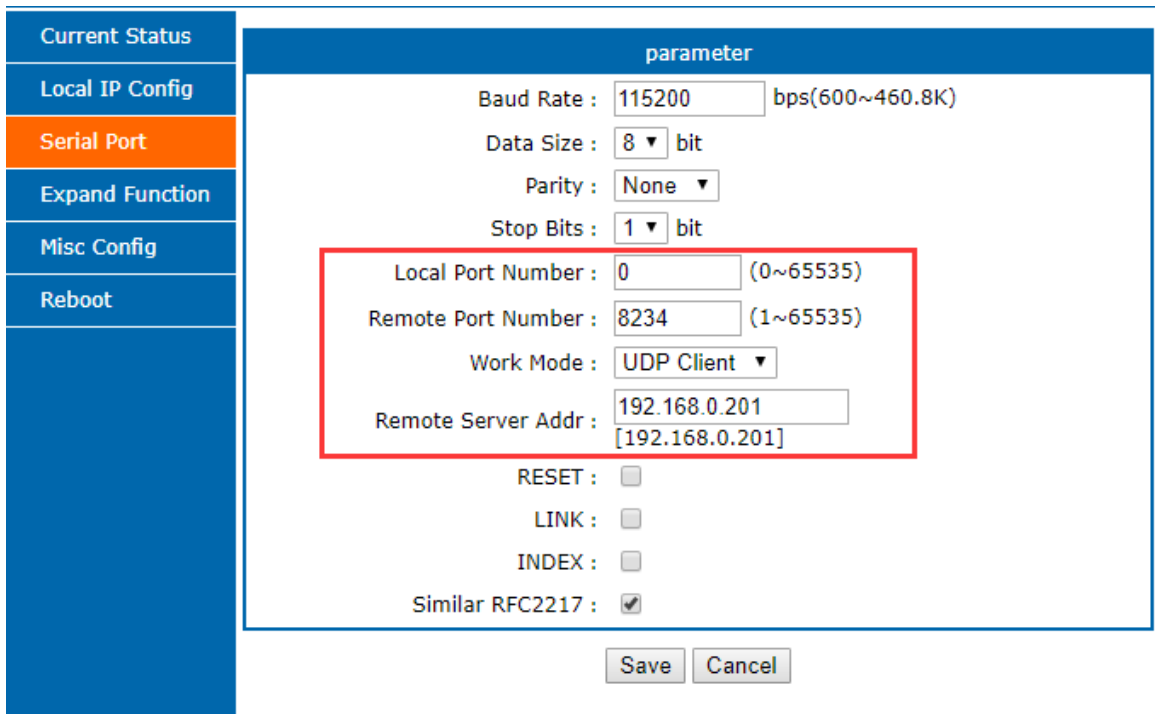

Diagram 4.2.3-3 UDP Client(webpage)

- ② Open USR-TCP232-TEST Software: set protocol to UDP, the local IP is the IP of the PC, and the local port number is the target port number of 302. Click Connect. Set the correct serial port parameters, click to open the serial port

- ③ Click “Send” at serial side. Remote IP and port becomes USR-DR302’s after receiving the data. Then click “Send” in network part and send data to COM.

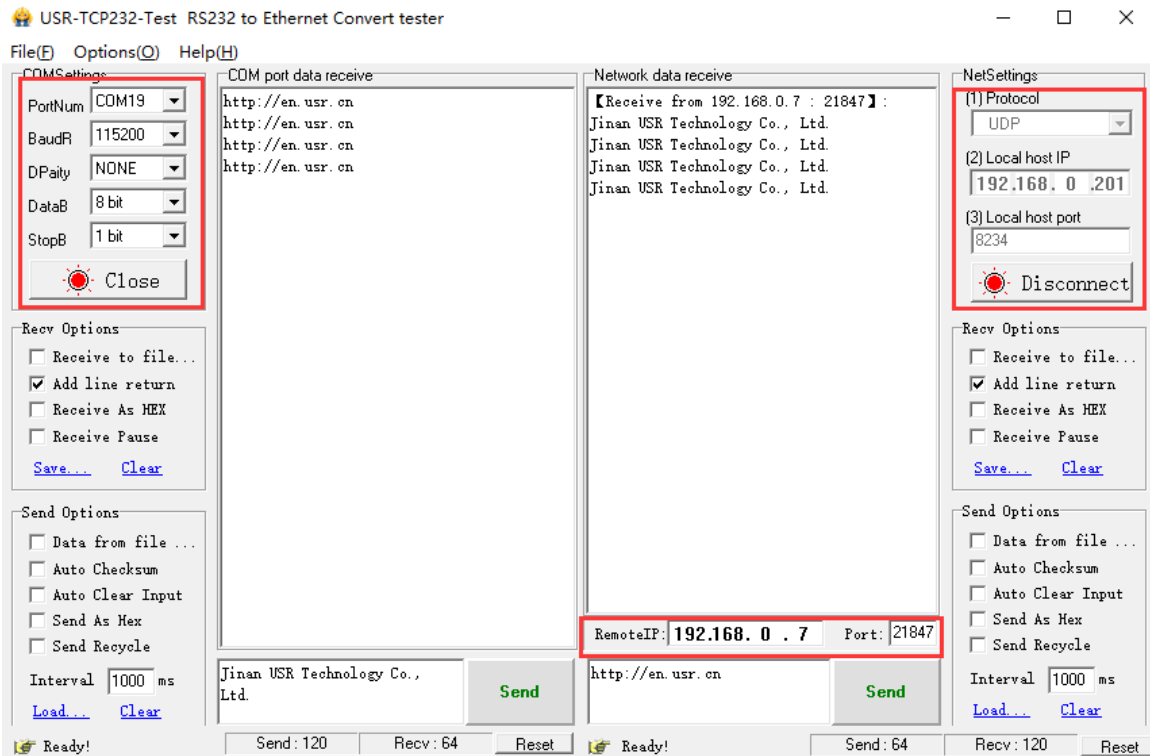

Diagram 4.2.3-4 UDP Client Test

4.2.4. UDP Server Mode

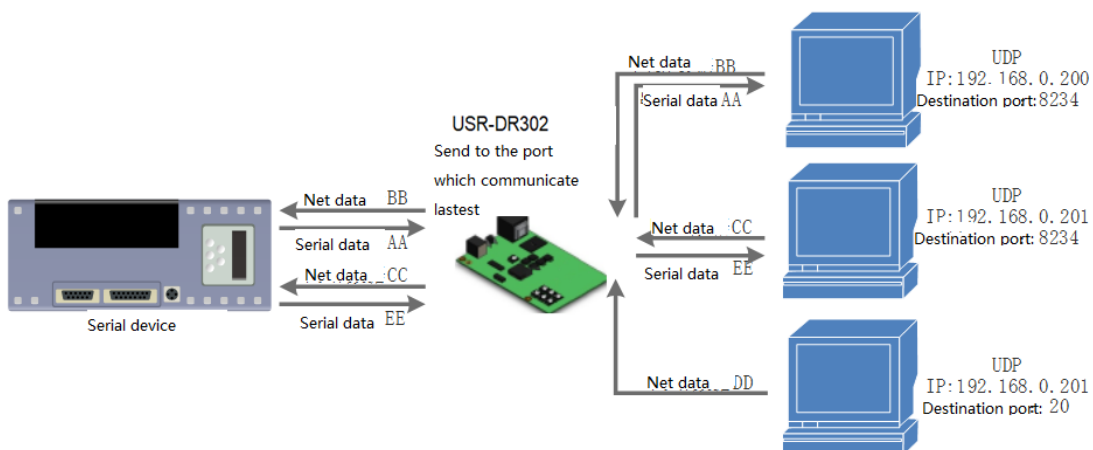

Diagram 4.2.4-1 UDP Server Mode

- 1) Base on normal UDP, it doesn't verify source IP address. Every time USR-DR302 receive one UDP data packet,

it changes destination IP to where data comes and it sends the data to the IP and port which communicate latest.

2) Used in the scenario several net device want to communication with the module with high speed and do not want to use the TCP mode.

3) Test Example:

① Open "USR-TCP232-MO_E45 Setup" Software: Set USR-DR302 as UDP Server, local port: 23.

② Open "USR-TCP232-TEST" Software twice. Set work mode as UDP, local host IP is the IP of PC.

The port numbers are set to two different port numbers. In this paper, 23 and 8234 are used as examples. Click" connect". On the network side, the target host all fill in the IP of DR302, and the port all fill in the local port number of DR302. Set the correct serial port parameters on one of the "USR-TCP232-TEST" software, click to open the serial port, and another serial port of "USR-TCP232-TEST" is ignored.

③ Click send at network side, serial port will receive all the data; click send at serial side, only one "USR-TCP232-TEST"software that communicate latest with DR302 can receive the data.

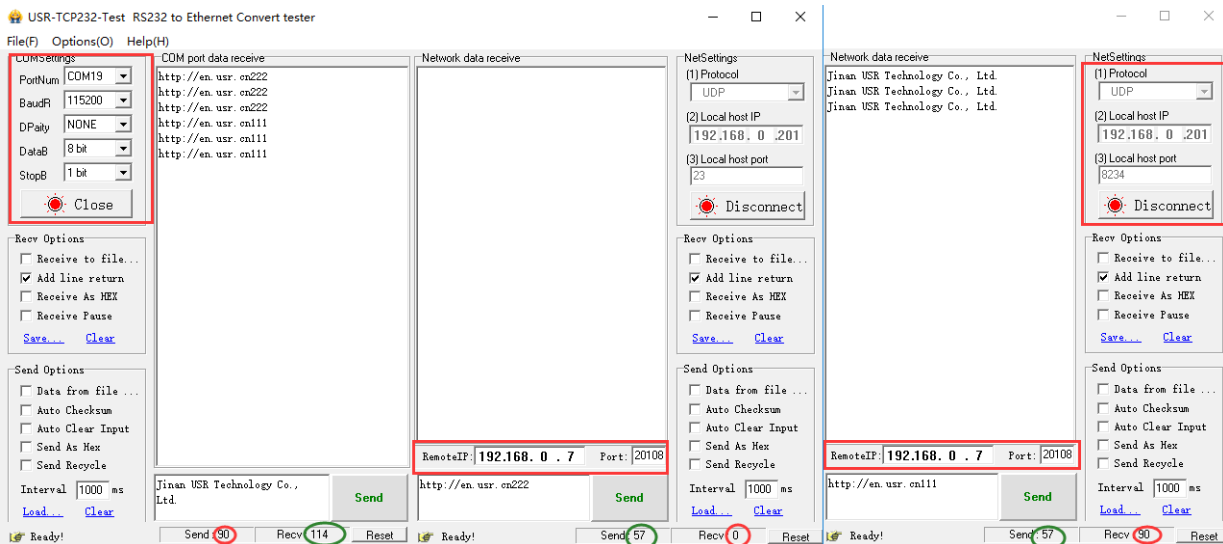

Diagram 4.2.4-2 UDP Server Test 1

4.2.5. HTTPD Client

1) In this mode, the user's terminal device can send request data to the specified HTTP server through DR302, and then DR302 receives the data from the HTTP server, parses the data and sends the result to the serial device.

2) User do not need to pay attention to the data conversion process between the serial port data and the network data packet, and the data request of the serial port device to the HTTP server can be realized by simple parameter setting.

3) When USR-DR302 sends data to HTTP server via serial port, set the URL, header remote domain name, IP and port and save, then it only needs to send the header of requested data; DR302 will automatically add information such as URL and header. The returned data, user can choose whether to remove the header.

4) Test example:

Current Status	parameter
Local IP Config	
Serial Port	
Expand Function	
Misc Config	
Reboot	
<div style="border: 1px solid #0056b3; padding: 10px;"> <p>Baud Rate : <input type="text" value="115200"/> bps(600~460.8K)</p> <p>Data Size : <input type="text" value="8"/> bit</p> <p>Parity : <input type="text" value="None"/></p> <p>Stop Bits : <input type="text" value="1"/> bit</p> <div style="border: 2px solid red; padding: 5px; margin: 5px 0;"> <p>Local Port Number : <input type="text" value="0"/> (0~65535)</p> <p>Remote Port Number : <input type="text" value="80"/> (1~65535)</p> <p>Work Mode : <input type="text" value="Httpd Client"/></p> <p>Remote Server Addr : <input type="text" value="test.usr.cn"/> [192.168.0.201]</p> <p>Httpd Chose : <input type="text" value="GET"/></p> <p>Httpd URL(<100byte) : <input type="text" value="/1.php?"/></p> <p>Httpd Header(<200byte) : <input type="text" value="User_Agent: Mozilla/4.0"/> Connection: close</p> <p>Remove Httpd Head : <input type="checkbox"/></p> </div> <p>RESET : <input type="checkbox"/></p> <p>LINK : <input type="checkbox"/></p> <p>INDEX : <input type="checkbox"/></p> <p>Similar RFC2217 : <input checked="" type="checkbox"/></p> <p style="text-align: center;"> <input type="button" value="Save"/> <input type="button" value="Cancel"/> </p> </div>	

Diagram 4.2.5-1 Httpd Client web page settings

1. Set USR-DR302 as HTTPD Client in webpage, and set the corresponding target port number and destination IP/domain name.
2. Set the Httpd request method and the URL and header information of the request packet at the web page.
3. Whether the header of the information replied by the Httpd server is removed can also be set in the web page.
4. After the setting is completed, click Save and restart DR302 to take effect.
5. Open the serial port to send data, then the serial port data will be submitted to the web server, and the serial port will also receive the information replied by the server.
6. For details on sending a request, refer to the "Httpd Client Mode Description" diagram, as shown below:

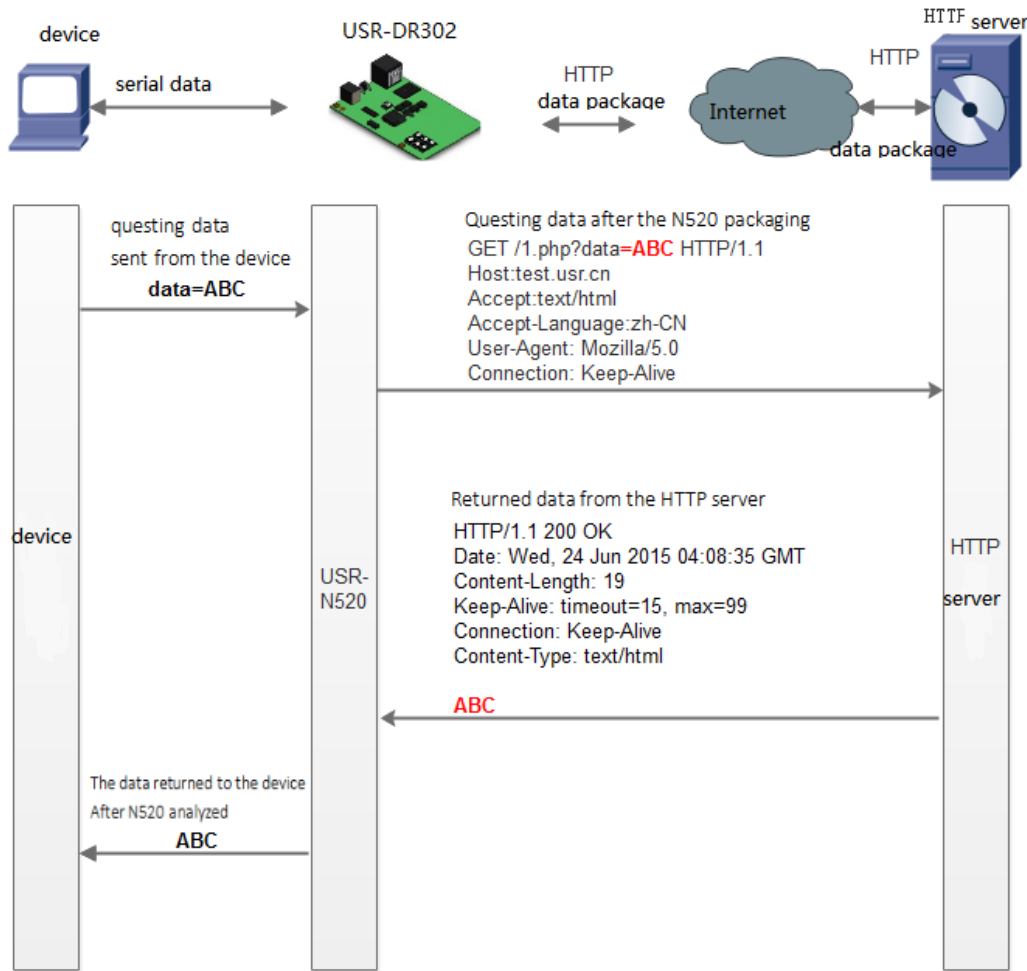

Diagram 4.2.5-2 HTTPD Client Mode

4.3. Impersistent Connection (TCP Short Link)

The use of TCP impersistent connections is mainly to save server resources, and is generally applied to a multi-point scenario. With short connections, you can ensure that the existing connections are useful connections and do not require additional controls for filtering.

The TCP impersistent connection function is applied to the TCP Client mode. After the short connection function is enabled, the message is sent. If there is no data reception in the serial port or network port within the set time, the connection will be automatically disconnected.

This function default disable, the time disconnection can be set from 2~255s, default is 3s.

Current Status	<div style="border: 1px solid #0070C0; padding: 5px;"> <p style="text-align: center; margin: 0;">parameter</p> <p>Heartbeat Packet Type : <input type="text" value="None"/> <input type="text" value="ASCII"/></p> <p>Register Packet Type : <input type="text" value="None"/></p> <div style="border: 2px solid red; padding: 2px;"> <p>Impersistent Connection : <input checked="" type="checkbox"/></p> <p>Disconnect Time : <input type="text" value="3"/> (s)(2~255)</p> </div> <p>TCP Server-kick off old connection : <input checked="" type="checkbox"/></p> <p>Buffer Data Before Connected : <input type="checkbox"/></p> <p>UART Set Parameter : <input type="checkbox"/></p> <p style="text-align: center; margin-top: 10px;"> <input type="button" value="Save"/> <input type="button" value="Cancel"/> </p> </div>
Local IP Config	
Serial Port	
Expand Function	
Misc Config	
Reboot	

Diagram 4.3-1 Short Link

4.4. Clean the buffer data

If the TCP have not built, the data that serial received will be placed in the cache, and the USR-DR302 serial port can receive 2Kbyte, after the TCP built, you can select whether to clear the cached data.

The default is not. Under the Httpd client mode or the TCP client mode, when enable the impersistent connection, this function has no power.

Current Status	<div style="border: 1px solid #0070C0; padding: 5px;"> <p style="text-align: center; margin: 0;">parameter</p> <p>Heartbeat Packet Type: <input type="text" value="None"/> <input type="text" value="ASCII"/></p> <p>Register Packet Type: <input type="text" value="None"/></p> <p>Impersistent Connection: <input type="checkbox"/></p> <p>TCP Server-kick off old connection: <input checked="" type="checkbox"/></p> <div style="border: 2px solid red; padding: 2px;"> <p>Buffer Data Before Connected: <input type="checkbox"/></p> </div> <p>UART Set Parameter: <input type="checkbox"/></p> <p>Modbus TCP: <input type="checkbox"/></p> <p style="text-align: center; margin-top: 10px;"> <input type="button" value="Save"/> <input type="button" value="Cancel"/> </p> </div>
Local IP Config	
Serial Port	
Expand Function	
Misc Config	
Reboot	

Diagram 4.4-1 clear buffer data Configuration

4.5. USR-VCOM Application

By using the supporting software VCOM (virtual serial port), receive the data from the specified virtual serial port, and then the data is sent out in the form of network data, thereby solving the problem that the PC end software cannot

communicate with the networked device for the serial port mode, and is convenient for the user to use. .

How to connect USR-DR302 with Virtual COM:

1. Set USR-DR302 as TCP server(DR302 works as server, It is convenient for users to change the computer and still be able to connect to the device.)
2. Open USR-VCOM software, click "Add COM" and select COM2 (Avoid existed COM).

Net Protocol: TCP Client

Remote IP and port is the IP and port of USR-DR302

Remarks: Can write the name of device

3. Click "OK" to check whether connection is built. "Connected" means ready for data transmission.

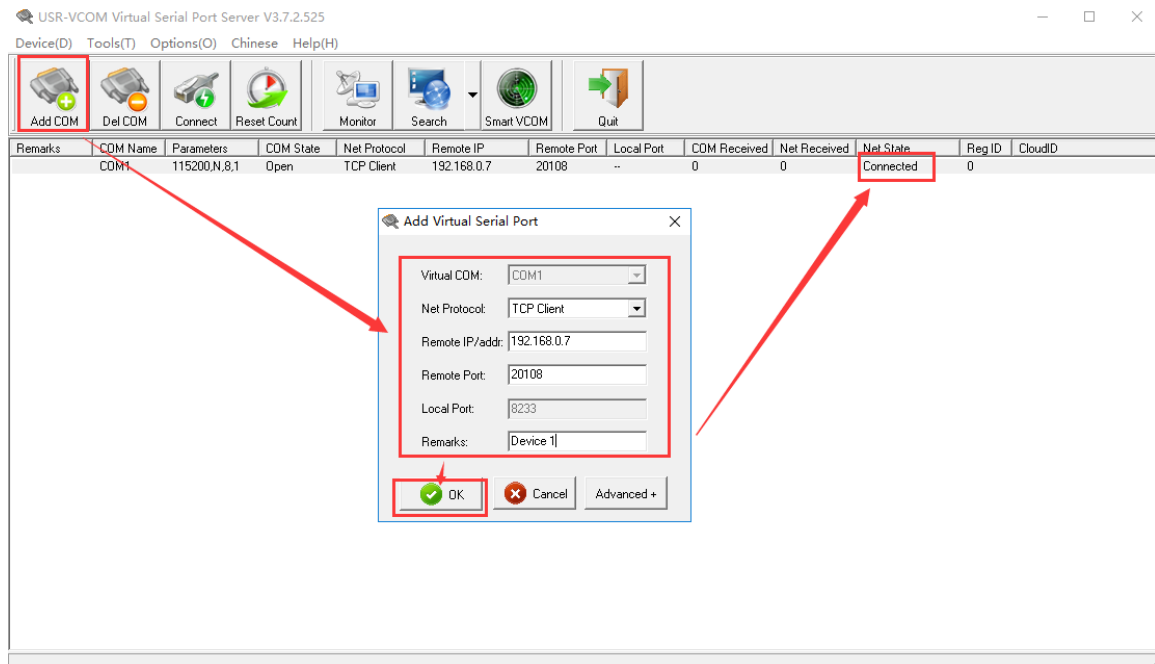

Diagram 4.5-1 USR-VCOM

4.6. Modbus Gateway

Modbus gateways include: Modbus RTU and Modbus TCP protocol conversion.

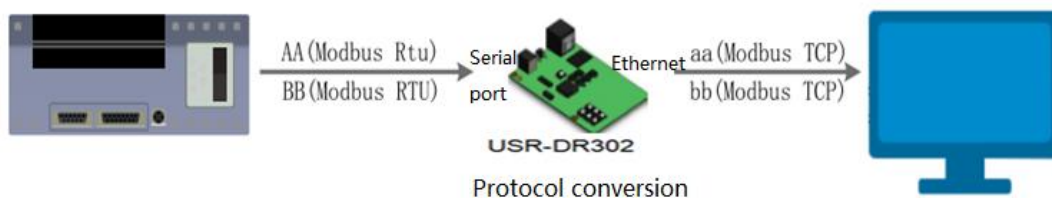

Diagram 4.6-1 MODBUS TCP

Modbus RTU and Modbus TCP: Modbus serial protocol to Modbus network protocol can be converted by Opening the Modbus TCP to Modbus RTU function in the web page.

Make the module work in the TCP server or the TCP client mode

Current Status	<table border="1"> <thead> <tr> <th colspan="2">parameter</th> </tr> </thead> <tbody> <tr> <td>Baud Rate :</td> <td>115200 bps(600~460.8K)</td> </tr> <tr> <td>Data Size :</td> <td>8 bit</td> </tr> <tr> <td>Parity :</td> <td>None</td> </tr> <tr> <td>Stop Bits :</td> <td>1 bit</td> </tr> <tr> <td>Local Port Number :</td> <td>502 (1~65535)</td> </tr> <tr> <td>Remote Port Number :</td> <td>8234 (1~65535)</td> </tr> <tr> <td>Work Mode :</td> <td>TCP Server</td> </tr> <tr> <td>Remote Server Addr :</td> <td>192.168.0.201 [192.168.0.201]</td> </tr> <tr> <td>RESET :</td> <td><input type="checkbox"/></td> </tr> <tr> <td>LINK :</td> <td><input type="checkbox"/></td> </tr> <tr> <td>INDEX :</td> <td><input type="checkbox"/></td> </tr> <tr> <td>Similar RFC2217 :</td> <td><input checked="" type="checkbox"/></td> </tr> <tr> <td colspan="2" style="text-align: center;"> <input type="button" value="Save"/> <input type="button" value="Cancel"/> </td> </tr> </tbody> </table>	parameter		Baud Rate :	115200 bps(600~460.8K)	Data Size :	8 bit	Parity :	None	Stop Bits :	1 bit	Local Port Number :	502 (1~65535)	Remote Port Number :	8234 (1~65535)	Work Mode :	TCP Server	Remote Server Addr :	192.168.0.201 [192.168.0.201]	RESET :	<input type="checkbox"/>	LINK :	<input type="checkbox"/>	INDEX :	<input type="checkbox"/>	Similar RFC2217 :	<input checked="" type="checkbox"/>	<input type="button" value="Save"/> <input type="button" value="Cancel"/>	
parameter																													
Baud Rate :		115200 bps(600~460.8K)																											
Data Size :		8 bit																											
Parity :		None																											
Stop Bits :		1 bit																											
Local Port Number :	502 (1~65535)																												
Remote Port Number :	8234 (1~65535)																												
Work Mode :	TCP Server																												
Remote Server Addr :	192.168.0.201 [192.168.0.201]																												
RESET :	<input type="checkbox"/>																												
LINK :	<input type="checkbox"/>																												
INDEX :	<input type="checkbox"/>																												
Similar RFC2217 :	<input checked="" type="checkbox"/>																												
<input type="button" value="Save"/> <input type="button" value="Cancel"/>																													
Local IP Config																													
Serial Port																													
Expand Function																													
Misc Config																													
Reboot																													

Diagram 4.6-2 Working mode

Webpage enable the modbus TCP to RTU function

Current Status	<table border="1"> <thead> <tr> <th colspan="2">parameter</th> </tr> </thead> <tbody> <tr> <td>Heartbeat Packet Type :</td> <td>None ASCII</td> </tr> <tr> <td>Register Packet Type :</td> <td>None</td> </tr> <tr> <td>Impersistent Connection :</td> <td><input type="checkbox"/></td> </tr> <tr> <td>TCP Server-kick off old connection :</td> <td><input checked="" type="checkbox"/></td> </tr> <tr> <td>Buffer Data Before Connected :</td> <td><input type="checkbox"/></td> </tr> <tr> <td>UART Set Parameter :</td> <td><input type="checkbox"/></td> </tr> <tr> <td>Modbus TCP :</td> <td><input type="checkbox"/></td> </tr> <tr> <td colspan="2" style="text-align: center;"> <input type="button" value="Save"/> <input type="button" value="Cancel"/> </td> </tr> </tbody> </table>	parameter		Heartbeat Packet Type :	None ASCII	Register Packet Type :	None	Impersistent Connection :	<input type="checkbox"/>	TCP Server-kick off old connection :	<input checked="" type="checkbox"/>	Buffer Data Before Connected :	<input type="checkbox"/>	UART Set Parameter :	<input type="checkbox"/>	Modbus TCP :	<input type="checkbox"/>	<input type="button" value="Save"/> <input type="button" value="Cancel"/>	
parameter																			
Heartbeat Packet Type :		None ASCII																	
Register Packet Type :		None																	
Impersistent Connection :		<input type="checkbox"/>																	
TCP Server-kick off old connection :		<input checked="" type="checkbox"/>																	
Buffer Data Before Connected :		<input type="checkbox"/>																	
UART Set Parameter :	<input type="checkbox"/>																		
Modbus TCP :	<input type="checkbox"/>																		
<input type="button" value="Save"/> <input type="button" value="Cancel"/>																			
Local IP Config																			
Serial Port																			
Expand Function																			
Misc Config																			
Reboot																			

Diagram 4.6-3 MODBUS TCP mode

Modbus TCP: click to enable the function or disable the function.

4.7. USR-Cloud Function

USR-Cloud software is a platform for communication between devices and PC software. The cloud software is mainly used for data transmission or monitoring remotely. This function only works in TCP client mode.

- Login link of USRIOT Cloud: <http://console.usriot.com>
- Remote server address: clouddata.usriot.com
- Local port: The port of device, Remote port: Cloud software's port

- Device ID: It is assigned to device by cloud software
- Communications Code: Pass word generated after adding the device to cloud software

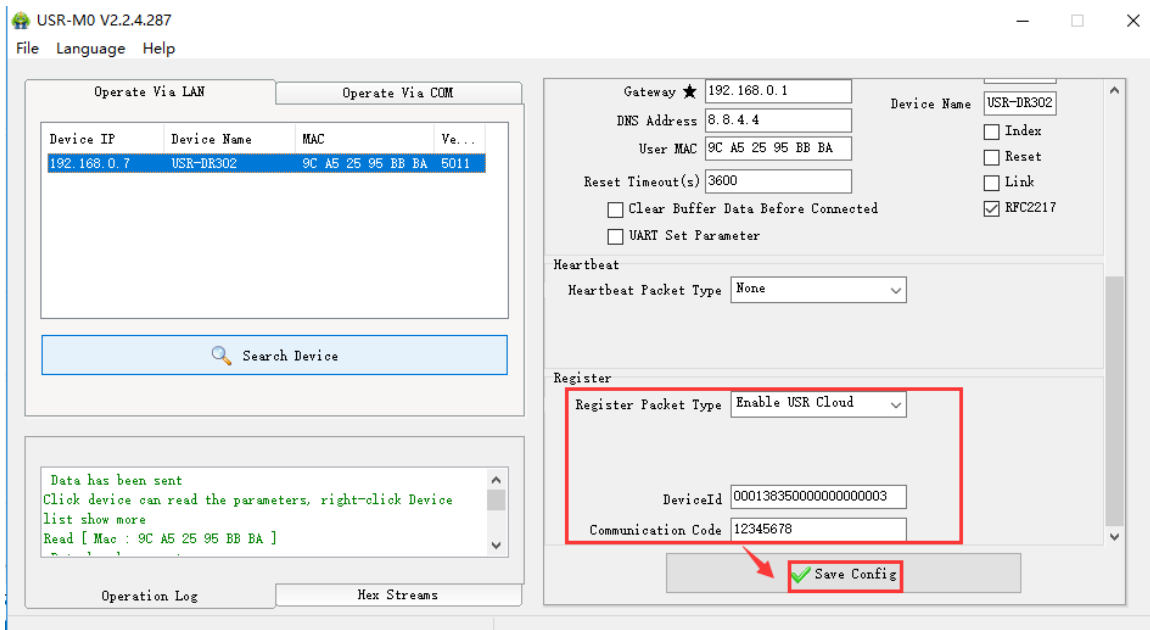
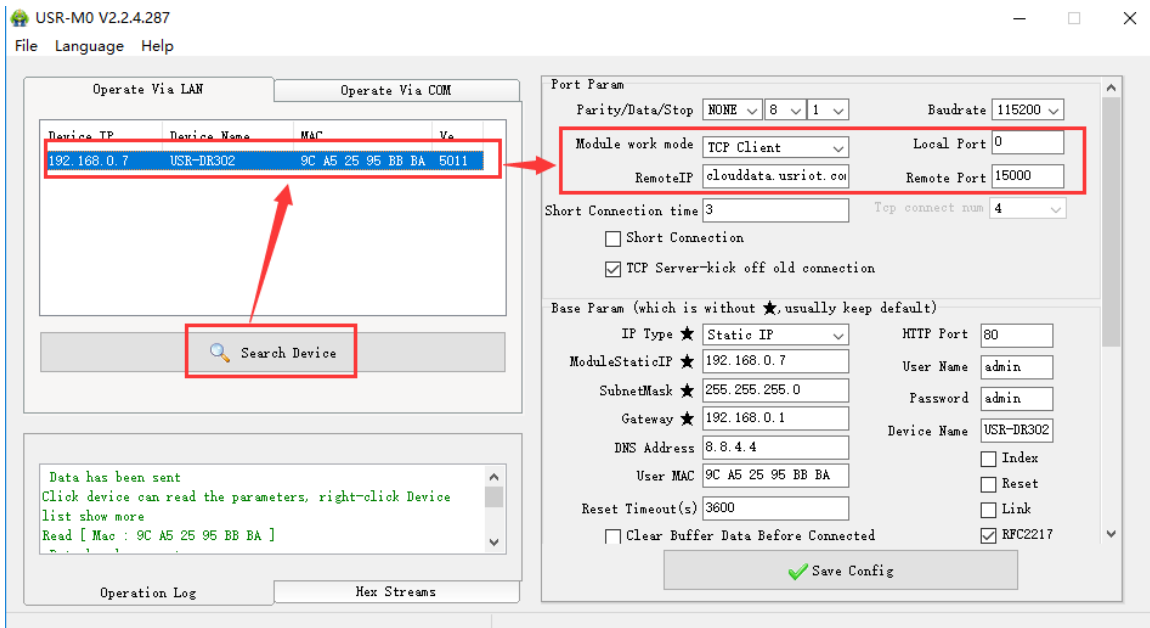

Diagram 4.7-1 USR-cloud (software)

Current Status	parameter	Current Status	parameter
Local IP Config	Baud Rate: <input type="text" value="115200"/> bps(600~460.8K)	Local IP Config	Heartbeat Packet Type: <input type="text" value="None"/> ASCII
Serial Port	Data Size: <input type="text" value="8"/> bit	Serial Port	Register Packet Type: <input type="text" value="Enable USR Clou"/>
Expand Function	Parity: <input type="text" value="None"/>	Expand Function	DeviceId: <input type="text" value="00013835000000000003"/>
Misc Config	Stop Bits: <input type="text" value="1"/> bit	Misc Config	Communication Code: <input type="text" value="12345678"/>
Reboot	Local Port Number: <input type="text" value="0"/> (0~65535)	Reboot	Impersistent Connection: <input type="checkbox"/>
	Remote Port Number: <input type="text" value="15000"/> (1~65535)		TCP Server-kick off old connection: <input checked="" type="checkbox"/>
	Work Mode: <input type="text" value="TCP Client"/>		Buffer Data Before Connected: <input type="checkbox"/>
	Remote Server Addr: <input type="text" value="clouddata.usriot.com"/> <input type="text" value="[192.168.0.201]"/>		UART Set Parameter: <input type="checkbox"/>
	RESET: <input type="checkbox"/>		Modbus TCP: <input type="checkbox"/>
	LINK: <input type="checkbox"/>		
	INDEX: <input type="checkbox"/>		
	Similar RFC2217: <input checked="" type="checkbox"/>		

Diagram 4.7-2 USR-cloud (webpage)

4.8. Other functions

4.8.1. Heartbeat Packet Function

Heartbeat packet is divided into network heartbeat and serial port heartbeat. It can send heartbeat packet to serial port or to network, can not send together.

Serial heartbeat packet: It can be sent to the serial port as a fixed query command. To reduce the communication flow, user can choose to send heartbeat package instead of the send query command from server. When there is data send from the serial port, serial heartbeat do not stop.

Network heartbeat packet: It used for maintaining connection. Only valid at the mode of TCP client and UDP client. When there is data transmission send from network interface, the net heartbeat packet stop.

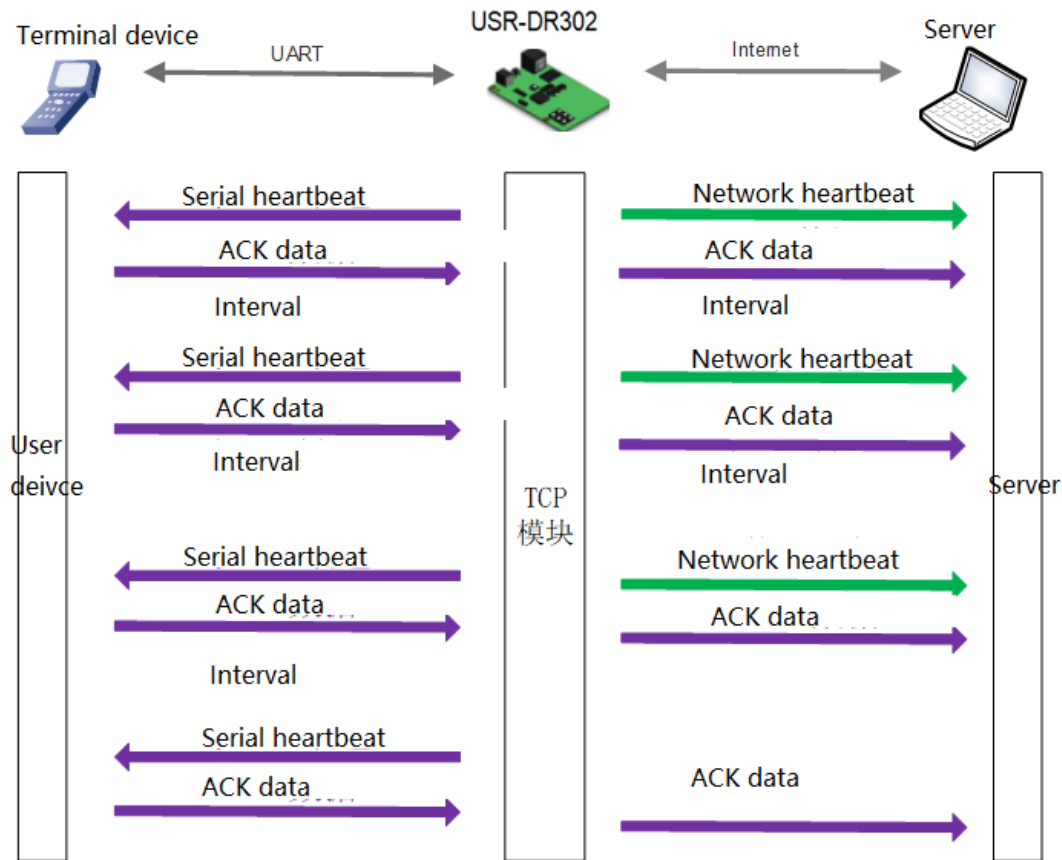

Diagram 4.8.1-1 Heartbeat packet function diagram

The heartbeat package feature is turned off by default. Set in the web page, the settings interface is as follows:

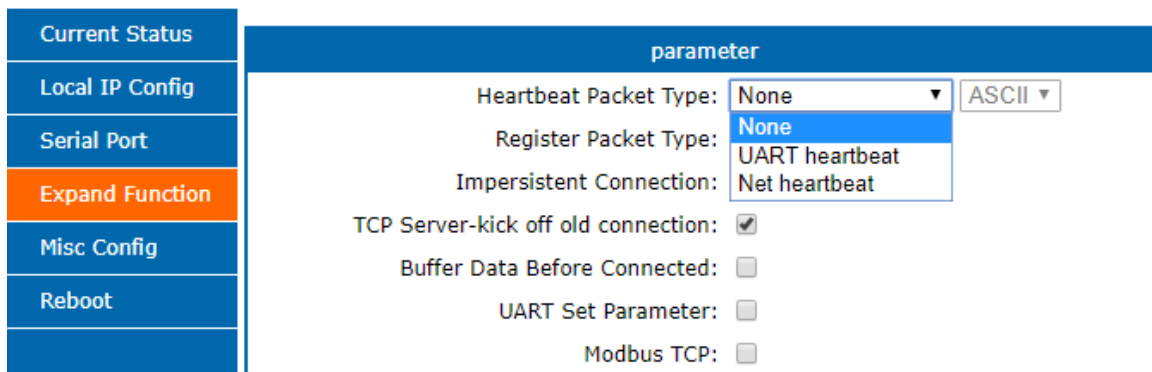

Diagram 4.8.1-2 Heartbeat Package

4.8.2. Registration Package Packet Function

USR-DR302 supports self-defined registration package function and also supports to send self-defined registration package after connection establishment, meanwhile, it supports to send registration package when sending data. There are three register package: USR-cloud, MAC register and self defined register.

Network registration packet includes: Establish a connection to send the registry packet, data carrying or both. The self-defined register content can be set according the requirement, at most for 40 bytes, supports HEX, MAC register package default is HEX, modify via change the MAC address.

Establish a connection to send the registry packet: Send the registration packet immediately after the connection is established. The main purpose is to allow the server to identify the data source device or to obtain a password for the server function authorization.



Diagram 4.8.2-1 Sending when establishing a connection

Data carrying: The packet header is carried uniformly when sending data. It used for protocol transmission.

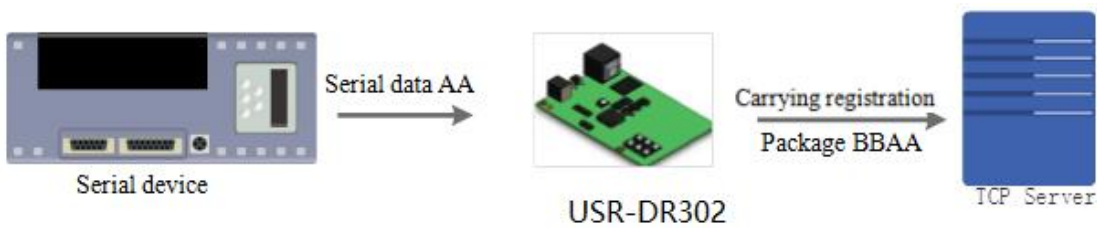

Diagram 4.8.2-2 Data carrying

Configure the relevant parameters via web page:

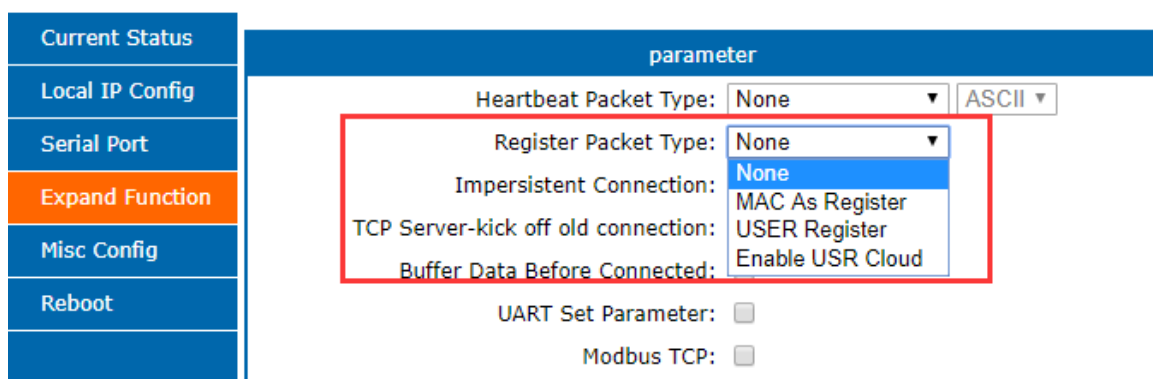

Diagram 4.8.2-3 Registration Package

4.8.3. Customized Webpage

DR302 supports custom webpage functions. By customizing webpages, customers can upgrade their webpage code (such as modifying logo or name) to DR302, which is more convenient for customers. Note that when upgrading a

custom web page, the Destination IP is set to the IP address of DR302, and the final web page file name must be "fs".

Steps:

1. **Download the software needed to upgrade . (Contact Sales@usriot.com)**
2. After editing the page code, open “USR-UpgradeHtml For Test V1.0.0.exe”, destination Ip is USR_DR302’ IP, port (1501), start address(8023000) and maxsize(1B000) fill as the below picture and do not change. The select path should be the file named “fs” then click upgrade.

Then upgrade.

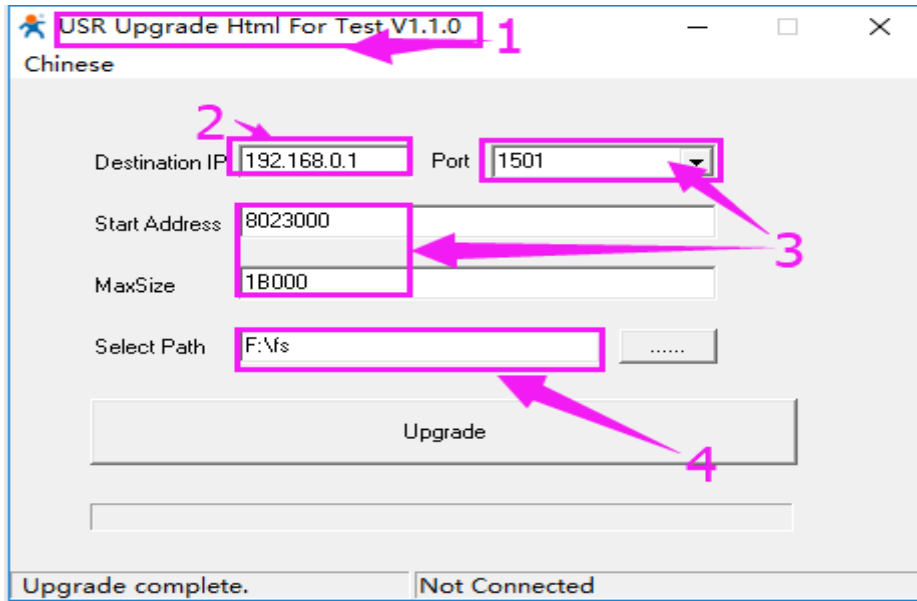

Diagram 4.8.3-1 Customized Webpage Upgrade

4.8.4. Link

Link pin is the status indicator pin for USR-DR302 to built communication. Link pin can be used as indication pin for TCP connection status.

When connected, it output low level; When unconnected, high level.

When USR-DR302 is under TCP model, Link pin will pull down. otherwise, it stays in high level.

When USR-DR302 is under DUP model, Link pin will always pull down. The "Link" alternate pin in the USR-DR302 can be used as a Link indication.

Note: for the link pin is in the shell, this function only can used on the USR-DR302 PCBA.

4.8.5. Index

At most there can be 8 links when the USR-DR302 in the TCP server mode. The max number can set from 1to 8 as you want. Here we take the default number is 8 as example. Server send data to 8 clients, or the server receive the data from 8 clients, open the Index, mark to divide the different clients and user can recognize the data sources according to the mark, meanwhile send different data to special clients.Index function can be set by software or web-page.

Enable the Index function and display the corresponding device number of the client before the communication data. The specific parameters are as follows:

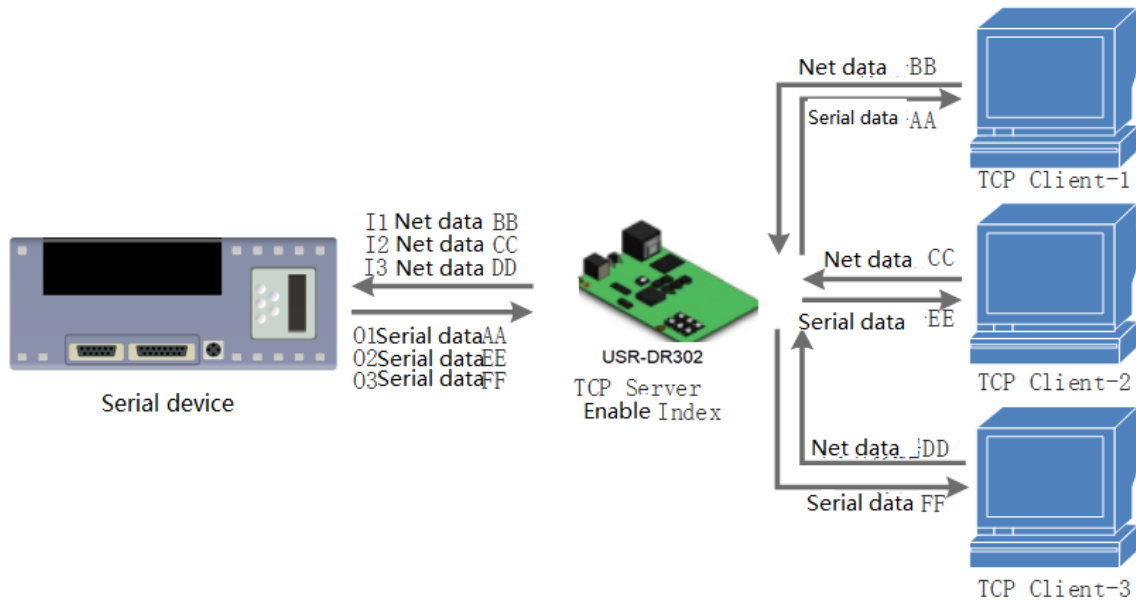

Diagram 4.8.5-1 Index Function

1. Server receive the data, Output 'I' 'N' data to the user MCU through the server serial port, "I" means receive and "N" means from which one Index. "N" from 31 to 40 in the HEX.
2. MCU fill the 'O' 'N' data..... into the server via the serial port of the serer. "O" means output, "N" means using which INDEX to send data.DR 302 send the data from the serial port to the net client.(plaease notice: 'o' is the code O in the ASCII, same as N, for example:'1','2' and so on) .
3. When there is new TCP connected to the server, DR 302 transports to the 'C' 'N' 'M'. Which means this connection is the N one and on total there is M.
4. If the number of the connections is up to 16, transports 'F' 'F' to the MCU if there is new connecion questing.
5. When disconnecting, DR302 send 'D' 'N' 'M' to MCU, the N means delete which one, and M means how many connection remaind.
6. The tansmission as below diagram

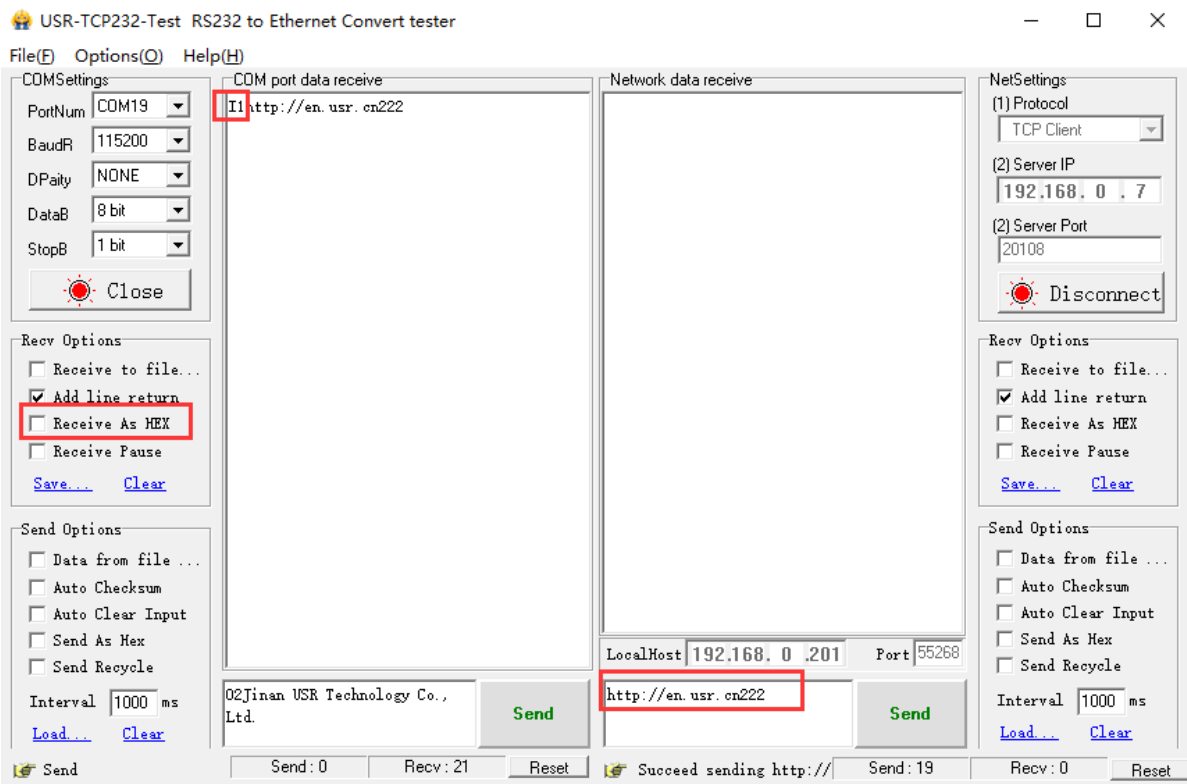
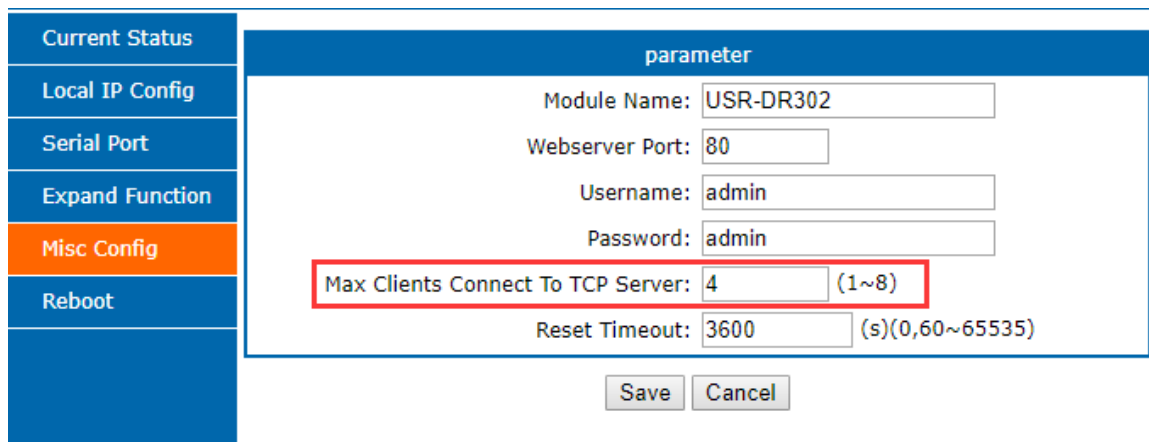

Diagram 4.8.5-2 Index data transmission

4.8.6. The number of the client connected

Then the USR-DR302 work in the TCP server mode, the max number of client to connect is 8, default is 4, the max number can be configuring as you want, which is be convenient for use. When the the number connecting clients more than 4, we should control the total data flow in 2.5KB/s if we need to send and receive meanwhile(not more than 200 bite/s).

If the number is 8 now, default use the new link instead of the oldest one, also you can set to use the older one. The webpage are as follow.



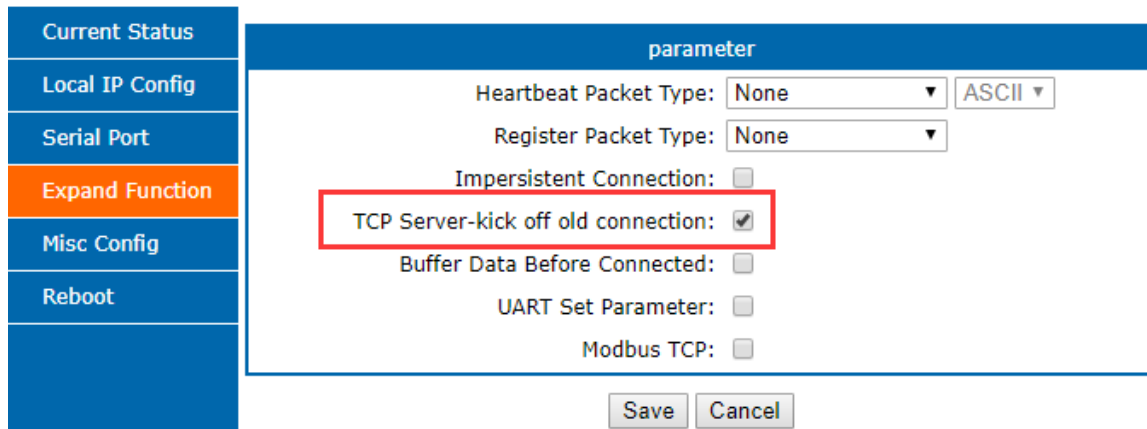

Diagram 4.8.6-1 max client connect to TCP server

4.8.7. Serial Port Packaging Mechanism

USR-DR302 can configure serial port packaging time and serial port packaging length. USR-DR302 will make packaging for the data of serial port according to the packaging length and packaging time in the transparent transmission mode. Default packaging time is 4 bytes and the length is 1024 bytes.

Example for judgment of packaging time and packaging length:

- ① Set packaging time as 10ms, packaging length as 512 bytes

When serial port received data, USR-DR302 will package and send it to network if the interval time of receiving data is over than 10ms or data length is more than 512.

- ② If the value of packaging time or packaging length is 0, the packaging rule is effective for non-zero one.

③ Set packaging time and length as 0. USR-DR302 will conduct default packaging time when packaging time is set as 0ms. Namely, when serial port receiving data, USR-DR302 will package and send the data to network if interval time more than packaging time of sending 4 bytes. For example, baud rate 115200, packaging time for 4 bytes is $T=0.4\text{ms}$, when the calculated value is smaller than 0.1ms, packaging time can be calculated as 0.1ms.

$$T = 1/\text{baud rate} * 10 * 4$$

4.8.8. Flow Calculation

When USR-DR302 receives data from network and then send to serial port, as the limit of serial port speed, user have to control the flow, if not the problem of data overflow on serial port side will occur. So data flow is required to calculated when sending data from network to serial port.

Example:

Network sends data in m bytes every n seconds. Method of checking if there is overflow: (Supposed network condition is good and network data transmission time is negligible)

① If there is no overflow, m bytes data must be transmitted within n seconds, then the transmitting time of M bytes data:

$$T = \frac{1}{\text{Baud Rate}} * 10 * m$$

If $n > 2T$, then data will not overflow, USR-DR302 can work normally. Just need keep $n > T$ under baud rate 9600.

4.8.9. Synchronous baud rate (RFC2217)

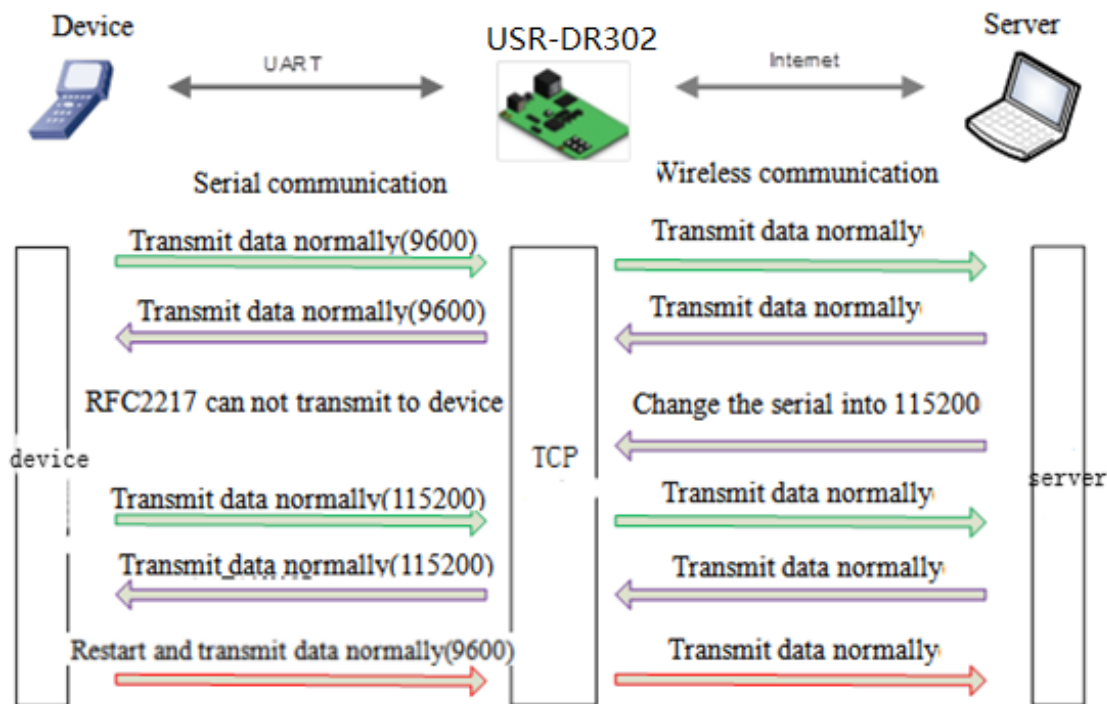

Diagram 4.8.9-1 RFC2217

For encryption during data transmission, devices change data bytes, baud rate, parity and so on. USR-DR302 supports revise serial parameter accordingly.

Synchronous baud rate is named RFC2217. USR Similar RFC2217 make adjustments on the basis of RFC2217 protocol to improve accuracy of transmission.

Protocol length is 8 bytes. And values taken for example is in HEX:

Name	Packet Header	Baud Rate	Bytes parameter	Parity
Bytes	3	3	1	1
Explanation	reduce misjudgment	High is in front, smallest is 600(00 02 58)	data bytes, baud rate, parity	Remove 4 bits of header and ignore the high bit
(115200,N,8,1)	55 AA 55	01 C2 00	03	C6

(9600,N,8,1)	55 AA 55	00 25 80	03	A8
--------------	----------	----------	----	----

Form 4.8.9-1 Example

Serial parameter bit:

Bit #	Explanation	Value	Description
1:0	Data bit selection	00	5 bits
		01	6 bits
		10	7 bits
		11	8bits
2	Stop Bit	00	1 bit
		01	2bits
3	Parity Enable	00	Disable Parity
		01	Enable Parity
5:4	Parity Type	00	ODD
		01	EVEN
		10	Mark
		11	Clear
7:6	NC	000	0

Form 4.8.9-2 Serial Parameters

Using methods:

1. [USR-TCP232-M0,E45](#) Setup software, click “Synchronous baud rate (RFC2217)”.
2. When serial parameter changes is needed, it send RFC 2217 packet. USR-DR302 receive the command from network and revise serial parameter accordingly, RFC2217 command do not transmit transparently
3. Application:

Protocol command

55AA5501C2008346 set the serial port parameters into 115200 N,8,1

55AA550025808328 set the serial port parameters into 9600 N,8,1

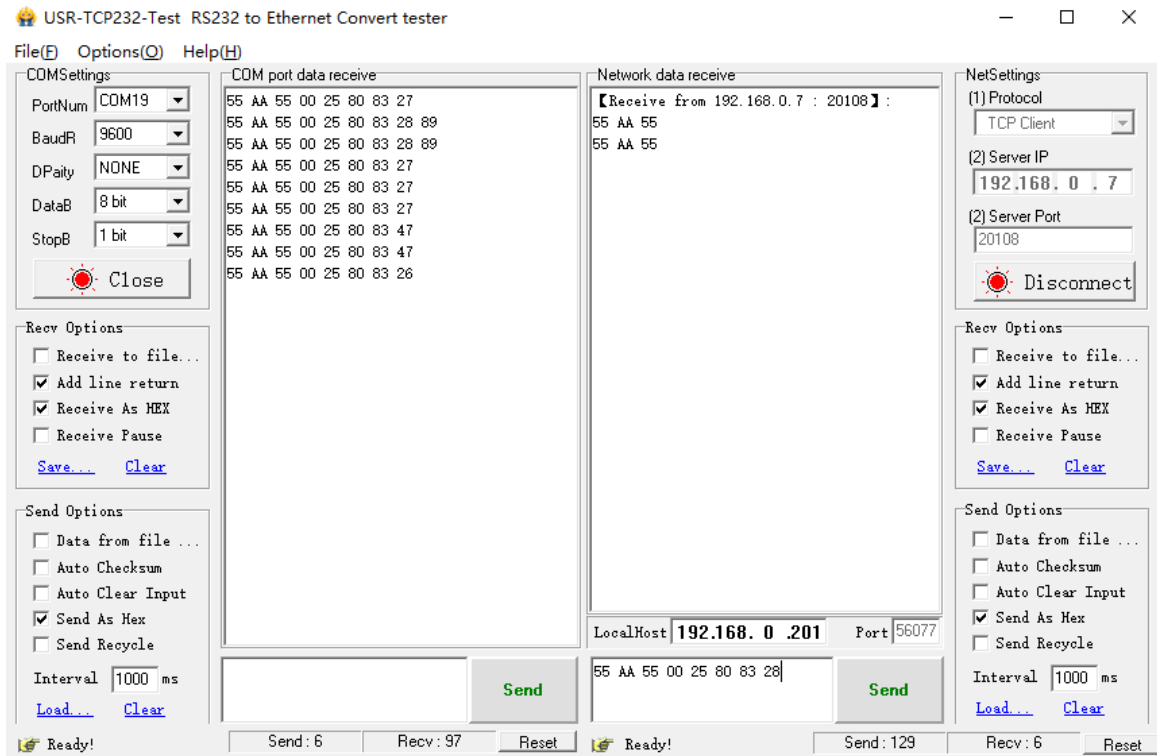

Diagram 4.8.9-2 RFC2217 Test

5. Setting Protocol

USR-DR302 includes two protocol: network setting protocol and serial port setting protocol.

5.1. Network Setting Protocol

To configure across the net, all the communication protocol using the UDP, lower one is in front. When user are configuring, please keep the remote port is 1500, and local port can be random.

5.1.1. Set Parameter Process

1. Build SOCKET:
Build UDP SOCKET, destination IP: 255.255.255.255, destination port: 1500. Low is in front.
2. Setting command process:
 - ① The network send searching command
 - ② USR-DR302 returns IP address and MAC
 - ③ The network read USR-DR302's parameter
 - ④ Organize setting command according to MAC, known user name/password and parameter to be configured.
 - ⑤ Send setting command
 - ⑥ USR-DR302 returns "correct setting"

- ⑦ Host PC send “save setting” command
- ⑧ USR-DR302 returns “correct”
- ⑨ Restart command
- ⑩ USE-DR302 returns “correct setting”

5.1.2. Setting Command Content

Command Look-up List:

Function	Header	Length	command	MAC (6 bytes)	User name /password (12bytes)	Parameter	Parity (sum)
search	FF	01	01	-	-	-	02
reset	FF	xx	02	[MAC]	[username] [password]	-	xx
read settings	FF	xx	03	[MAC]	[username] [password]	-	xx
Basic settings	FF	xx	05	[MAC]	[username] [password]	Basic parameter	xx
Com 0 settings	FF	xx	06	[MAC]	[username] [password]	COM parameter	xx
Restore to factory set	FF	xx	0b	[MAC]	[username] [password]	-	xx
USR Cloud	FF	xx	0c	[MAC]	[username] [password]	Serial parameters	xx
Heartbeat and register package setting			21		[username] [password]	Serial parameters	xx
Extend setting	-	-	-	-	-	-	-

Form 5.1.2-1 Command

Notice: Check bit is sum check, starts from length byte (including length) to adding before checking (not including checking), result is check value, only low byte is remained.

1. Command examples

① Search command example

Search command is set to:

FF 01 01 02

Sum check: 02 = 01 + 01

② Reset command example

Send bytes: FF 13 02 00 71 77 7c 42 2F 61 64 6d 69 6e 00 61 64 6d 69 6e 00 Fc

Sum check:

$Fc = 13 + 02 + \dots + 6E + 00$

From 4th to 9th is the MAC of the DR302, the last 12 bytes before the sum check is the username and password
User name and password both are 6 byte, bits 0 for the lack. (the last one of the username and password must be

0)

③ Read settings command example

Send (22 bytes): FF 13 03 00 71 77 7c 42 2F 61 64 6d 69 6e 00 61 64 6d 69 6e 00 Fd

Sum check:

$Fd = 13 + 03 + \dots + 6E + 00$

From 4th to 9th is the MAC of the DR302, the last 12 bytes before the sum check is the username and password
User name and password both are 6 byte, bits 0 for the lack. (the last one of the username and password must be

0)

2. Some commands detailed annotation

① Basic setting parameter command

On totally, there are 67 basic setting command, here we take an example for the better setting and using:

Send: FF 56 05 00 71 77 7c 42 2F 61 64 6d 69 6e 00 61 64 6d 69 6e 00 95 63 03 00 00 00 50 00 00 07 00 a8 c0 c9
00 a8 c0 00 FF FF FF 55 6c 6c 2d 66 32 00 00 00 00 00 00 00 00 61 64 6d 69 6e 00 61 64 6d 69 6e 00 00 01
00 00 00 00 00 00 00 00 00 00 00 00 00 00 00 00 00 00 04

Sum check: $04 = 56 + 05 + 00 + \dots + 01$

From 4th to 9th is the MAC of the DR302, from 10th to 22nd is username and password, later bytes is the basic parameters for fix the length, last one is sum check.

Basic Parameter:

Name	Byte	Example	Explanation
ucSequenceNum	1	00	Write the read values
ucCRC	1	00	Write the read values
ucVersion	1	00	Write the read values
ucFlags	1	C0	IP address type: 0 in 8 th bit: DHCP;1 in 8 th bit: Static IP
usLocationURLPort	2	00 00	Write the read values
usHTTPServerPort	2	50 00	HTTP server port
ucUserFlag	1	00	Write the read values
ulStaticIP	4	07 00 A8 C0	Static IP
ulGatewayIP	4	C9 00 A8 C0	Gateway
ulSubnetMask	4	00 FF FF FF	Subnet Mask
ucModName	16	55 53 52 2D 4B 32 00 00 00 00 00 00 00 00 00	USR-DR302 name
Reserve protocol	2	00 00	Please set to be 0
username	6	61 64 6D 69 6E 00	username
password	6	61 64 6D 69 6E 00	password
ucNetSendTime	1	00	Disable and reserve protocol
uild	2	01 00	Device ID
ucldType	1	00	Device ID type (0~3) 0:no use 1st 1:send id when connect; 0; disable 2nd 1:send id when send data; 0; disable 5th 1: reset enable; 0: disable 6th 1: link enable; 0: link disable 7th 1: index enable; 0: close 8th 1:RFC2217 enable; 0: disable
MAC_addr	6	D8 B0 4C 11 22 33	MAC
DNSGatewayIP	4	01 00 A8 C0	DNS server address
TC_sh_time	1	03	Disconnection time for short link
ucReserved	3	00 00 00	Unused

Form 5.1.2-2 Basic Parameters

② Port settings parameter command

Port parameter:

Name	bytes	example	Explanation
ulBaudRate	4	00 C2 01 00	Baud Rate
ucDataSize	1	08	COM data bits (0x05/0x06/0x07/0x08)
ucParity	1	01	COM parity 1: no, 2: odd, 3: even, 4: mark, 5: space
ucStopBits	1	01	COM stop bit (0x01/0x02)
ucFlowControl	1	00	Disable and reserve
ulTelnetTimeout	4	00 00 00 00	Disable and reserve
usTelnetLocalPort	2	8C 4E	Local Port
usTelnetRemotePort	2	2a 20	Remote Port
uiTelnetURL	30	31 39 32 2E 31 36 38 2E 30 2E 31 00 00 00 00 00 00 00 00 00 00 00 00 00 00 00 00 00 00 00	IP address send in ASCII. Example: 192.168.0.201
ulTelnetIPAddr	4	00 00 00 00	Not adopted
ucFlags	1	00	5 th 0: close cloud 1: enable 6 th 0: under the TCP server, do not kick the old connection 1: kick the oldest one 7 th 0:disable MAC register; 1: take MAC as register
ucWorkMode	1	01	Working mode: 0: UDP, 1: TCP Client, 2: UDP Server, 3: TCP Server, 4: HTTPD Client
HTPucFlags	1	00	0: HTTPD GET; 1: HTTPD POST
tc_number	1	04	The number of the client connected to the TCP Server
Timeout_restart	2	00 00	Restart time
cos_register_flag	1	00	Self- defined register
ucTimeCount	1	91	Write the read values
uiPackLen	2	00 00	reserve
ucReserved	3	00 00 00	saved

Form 5.1.2-3 Port Parameters

Example:

```
FF 52 06 00 71 77 7c 42 2F 61 64 6d 69 6e 00 61 64 6d 69 6e 00 00 c2 01 00 08 01 01 01 00 00 00 00 8c 4e 2a 20
31 39 32 2e 31 36 38 2e 30 2e 32 30 31 00 00 00 00 00 00 00 00 00 00 00 00 00 00 00 00 00 00 00 c9 00 a8c0 00 01 00
```

			8 th 1: enter the register package in HEX
heart_times	2	00 1e	heart beat time
heart_len	1	00	Heartbeat package length
register_len	1	00	Register package length
heartbeat	40	00 00	Heartbeat package content
register_s	40	00 00	Register package

5.1.3. Commands' Return Content

1. Return results of search command

Return command:

Bytes	Name	Example	Explanation
0	TAG_STATUS	FF	Fixed number
1	Packet_length	24	Fixed number
2	CMD_DISCOVER_TARGET	01	Fixed number
3	Board_type	00	Fixed number
4	Board_ID	00	Fixed number
5~8	Client_IP_address	C0 A8 00 07	Device IP(High in front)
9~14	MAC_address	AC CF 23 20 FE 3D	Device MAC(High in front)
15~18	Fireware_version	01 00 00	device version#
19~34	Application_title	55 53 52 2D 4B 32 00 00 00 00 00 00 00 00 00 00	Device name
35	checksum	F0	checksum

Diagram 5.1.3-1 Return Command

Example:

Return results of search command(36 bytes)

FF 24 01 00 00 c0 a8 00 07 00 71 77 7c 42 2F 01 0c 00 00 55 53 52 2d 4b 32 00 00 00 00 00 00 00 00 00 00 F2

Parity method is reduce sum check. initial value is 0 x00, then reduce the byte one by one.

The method of the check is as follow:

F2 = 00 - FF - 24 - 01 - 00 - 4B - ... - 32 - 00-...-00

2. Return results of reset command

Response(4 bytes): FF 01 02 4B, if user name and password are right, 4B = 'K'

FF 01 02 50, if user name and password are wrong, 50 = 'P'

3. Return results of read command

Description:

Return all parameter of DR302 network. 567 bytes in total, no parity, no protocol, return parameter directly.

Return data divide into 4 package, 130bytes, 50 bytes,85 bytes and 302bytes.

For example:

95 63 03 00 00 00 50 00 00 07 00 A8 C0 01 00 A8 C0 00 FF FF FF 55 53 52 2D 54 43 50 32 33 32 2D 33 31 30 00 00
61 64 6D 69 6E 00 61 64 6D 69 6E 00 01 00 A4 AC CF 23 20 FE 10 00 00 00 00 00 00 00 00 80 25 00 00 08 01 01 01
00 00 00 00 8C 4E 2A 20 31 39 32 2E 31 36 38 2E 31 2E 31 33 33 00 00 00 00 00 00 00 00 00 00 00 00 00 00 00 00
85 01 A8 C0 00 01 00

00
00 00

00 30 00
00
00 00 00 00 00 00;

07 2F 31 2E 70 68 70 3F 00
00
00
00
00
00
00
00 00

Return:FF 01 03 50 if the password is wrong and no parity.

4. Return results of basic settings command

FF 01 05 4B with right password:4B="k"

FF 01 05 50 with wrong password:50="P"

5. Return results of serial parameters settings command

FF 01 06 4B with right password:4B="k"

FF 01 06 50 with wrong password:50="P"

6. Return results of USR-cloud command

FF 01 06 4B with right password:4B="k"

FF 01 06 50 with wrong password:50="P"

7. Return results of heartbeat package command

FF 01 06 4B with right password:4B="k"
 FF 01 06 50 with wrong password:50="P"

8. Others return results
 Sum check fault returns 'E' + right parity
 Correct execution: FF 01 CMD 'K'
 User name/password fault returns: FF 01 CMD 'P'
 Others faults return: FF 01 CMD 'E'

5.1.4. Listening Report Method

Using the below wan to catch the report.
 Please using the set-up software M0

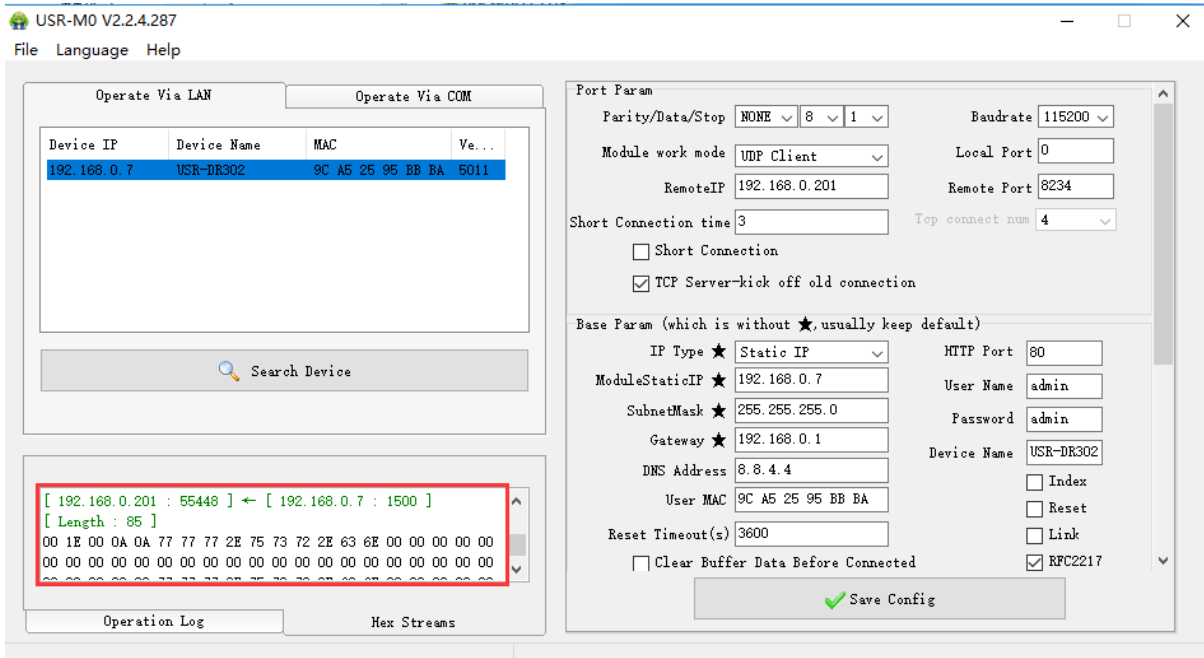

Diagram 5.1.4-1 Catch the report

5.2. Serial Setting Protocol

5.2.1. AT Command Overview

For USR device is in transparent mode normally, you must enter AT command mode at first. Then you can send AT command to configure or query the settings. After you configure the USR device, you should restart the USR device to make the settings take effect. Every time module restart will work in work mode rather AT command mode. Every AT command must add character carriage return <CR> and line feed <LF>. In Hex, <CR> is 0x0D <LF> is 0x0A.

Powered successfully, we can setting the module with UART.

The default UART port parameters of the module are: baud rate 115200, no parity, data 8 and stop 1.

Recommend to use secureCRT software tool or testing program of USRIOT.

Below are using the secureCRT to operate AT command:

Need two step as below:

- Fill “+++” in the UART. After the module receive the “+++”, then will return an “a” to confirm;
- When you receive an 'a' then you need to send other 'a' within 3 seconds
- After that, module will return “+ok” to enter into the command mode.

Fill “+++” and “a” need to achieve in the time to reduce the chance of entering command mode while working normally accidentally. Detail requirement are as follows.

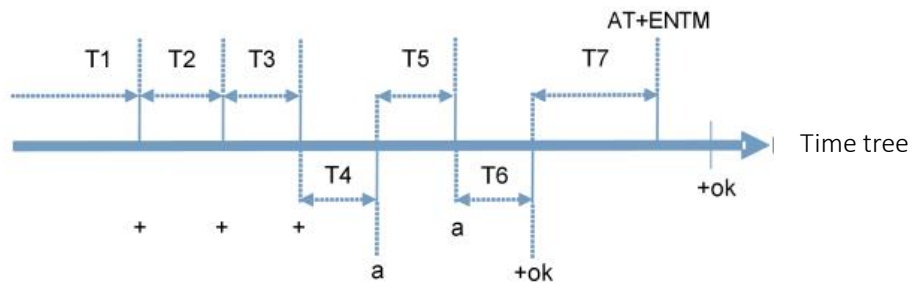

Time requirement:

T1 > the interval of serial port package

T2 < 300ms

T3 < 300ms

T5 < 3s

Change transparent transmission mode to AT command mode :

1. Serial mode device send “+++” to module continuously. If the module received ‘+++’ successfully then it will send “a” back.
2. When module received “a” and then user need to send other “a” to uart within 3s.
3. The module will return ‘+ok’ when module received ‘a’ successfully. And enter into command mode

Change AT command mode to transparent transmission mode:

1. Serial device send “AT+ENTM” to module.
2. After the module receive the command, feedback “+ok”, then back to the previous working mode.

Input AT command via CRT serial debugging of programmer

Based on the ASCII command , the format of the AT command are as below:

< >: the content that you have to choose

[]: the part can be select

Command:

AT+<CMD>[op][para-1,para-2,para-3,para-4...]<CR><LF>

AT+: command prefix

[op]L: command operating code, parameters setting or query;

“=” parameters setting

“NULL” query

[para-n] fill when setting the parameters

<CR>: end, enter , ASCII code,: 0X0D

<LF> : line feed, ASCII code:0X0D

Note: if enable the echo function(AT+E), the command enter will be send back, end code <CR> will not.

Response data

<CR><LF>+<RSP>[op] [para-1,para-2,para-3,para-4...]<CR><LF>

+: the response prefix

RSP: response code ,including:

Ok

Err

[para-n]: return parameters or the error code:

<CR>:ASCII code: 0x0d;

<LF>: ASCII code :0x0a;

5.2.2. Error Code

List of Error Code

Error	State
-1	Invalid command format
-2	Invalid command
-3	Invalid Operator
-4	Invalid Parameters
-5	Operation not allowed

5.2.3. AT Command

AT Command List:

NO	command	Instr
1	E	Enable/disable the echo function
2	Z	Restore module
3	VER	Query the vision
4	ENTM	Exit AT command mode
5	RELD	Reset default settings
6	MAC	Query module MAC address
7	WEBU	Setting/ query username and password
8	WANN	Setting/ query WAN port parameters
9	DNS	Setting/ query DNS server address
10	WEBPORT	Setting/ query webpage port
11	UART	Setting/ query serial parameters

12	SOCK	Setting/ query SOCK parameters
13	TCPSE	Setting/ query whether kick off order connection
14	SOCKLK	Query TCP connect status
15	SOCKPORT	Setting/ query local port number
16	RFCEN	Setting/ query RFC2217 enable
17	PDTIME	Query the product time
Registration package function		
18	REGEN	Setting/ query registration package mechanism
19	REGTCP	Setting/ query registration package perform mechanism
20	REGCLOUD	Setting/ query USR-cloud username and password
21	REGUSR	Setting/ query the content of registration package that customized
Httpd client function		
22	HTPTP	Setting/ query in httpd client mode, the asking way of the http
23	HTPURL	Setting/ query the URL in httpd client mode
24	HTPHEAD	Setting/ query the package head in httpd client
25	HTPCHD	Setting/ query HTP remove the package head
Heartbeat package		
26	HEARTEN	Setting/ query heartbeat package enable
27	HEARTTP	Setting/ query method of the heartbeat package send
28	HEARTTM	Setting/ query the heartbeat package time
29	HEARTDT	Setting/ query customize heartbeat package
Expand function command		
30	SCSLINK	Setting/ query the indicating function of the status of socket connection
31	CLIENTRST	Setting/ query the TCP client mode reset function enable/disable
32	INDEXEN	Setting/ query index function
33	SOCKSL	Setting/ query short connection function
34	SHORTO	Setting/ query short connection time
35	UARTCLBUF	Setting/ query clear serial port cache before module build connection function enable/disable
36	RSTIM	Setting/ query timeout reset time
37	MAXSK	Setting/ query maximum client connections in TCP server mode
38	MID	Setting/ query module name
39	MODTCP	Query /setting the name of the module
40	H	Query help message

6. Parameter Configuration

It is setup software configuration, webpage configuration and serial configuration.

How to configure:

Revise user name/password→set IP access method→serial parameter→USR-N520 work mode→work mode related parameter

6.1. Software Configuration

To make sure setup software normal running, please check the below firstly:

1. USR-DR302 and setup software PC are within same LAN.
2. Disable the anti-virus software and firewall on PC.
3. Disable network card nothing to do with this testing.

Download [USR-M0] Setup software here:

<https://www.usriot.com/support/downloads/usr-m0-setup-software-v224288.html>

Search device and all USR-DR302 device within LAN can be found. It includes IP, name, MAC and version.

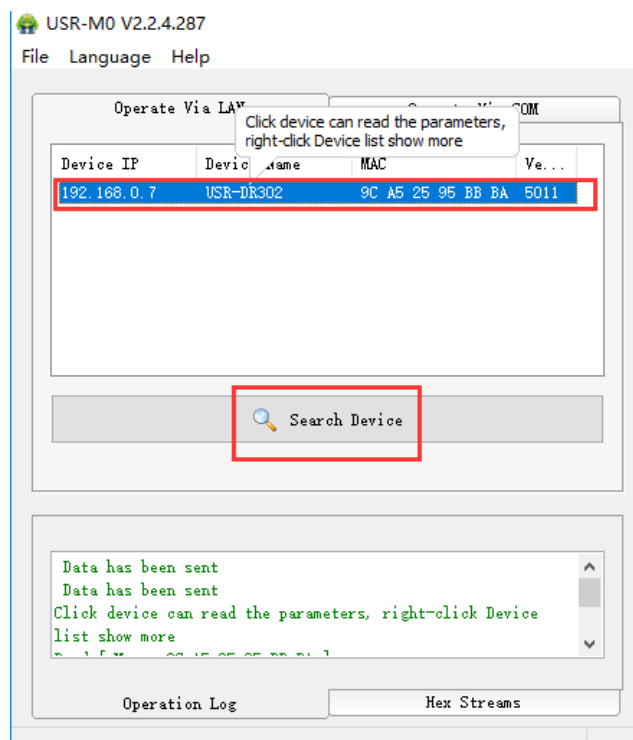

Diagram 6.1-1 Software Configuration—Search

1. Basic parameter configuration
 Click “Full Show” and all basic parameter is revealed.
 Set the parameter as needs and click “Base Save” then can set successfully.

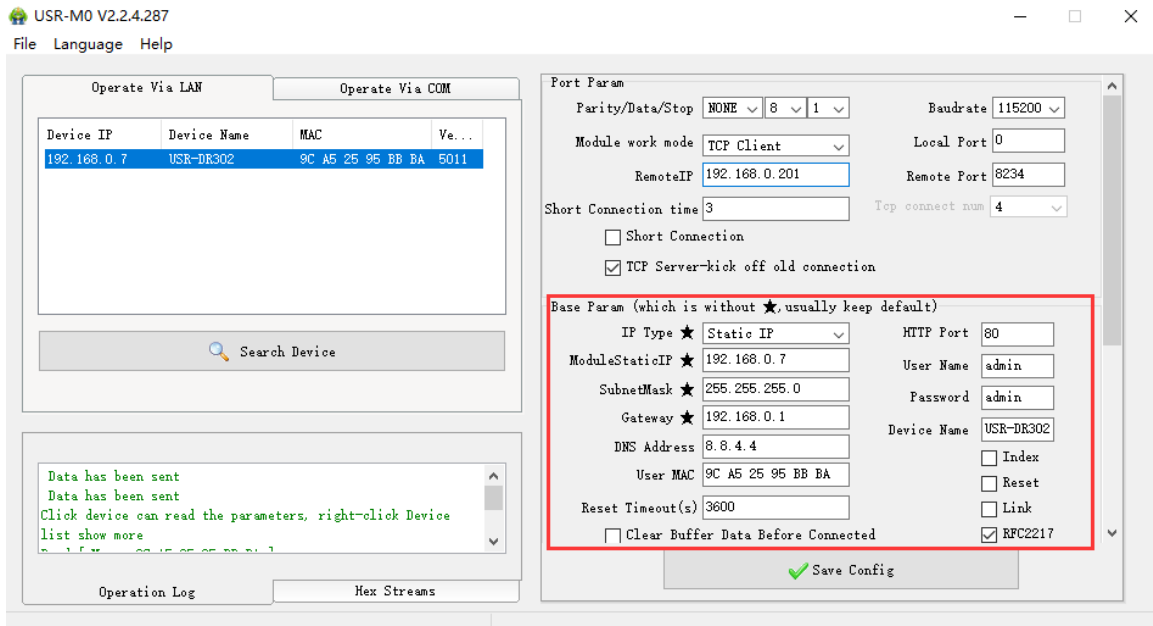

Diagram 6.1-2 Software Configuration --Full Show

- Webpage port: it is 80 by default when visit webpage.
- User name: Authentication Code for revising parameter to avoid other users within same LAN revising it.
- Password: same as user name.
- Device Name: USR-DR302 's name an be revised.
- IP address type: Static and DHCP
- Static IP: same segment with router.
- Subnet Mask: 255.255.255.0 by default.
- Gateway: it is router IP generally, can transmit cross network segment and DNS if set correctly.

2. Port configuration

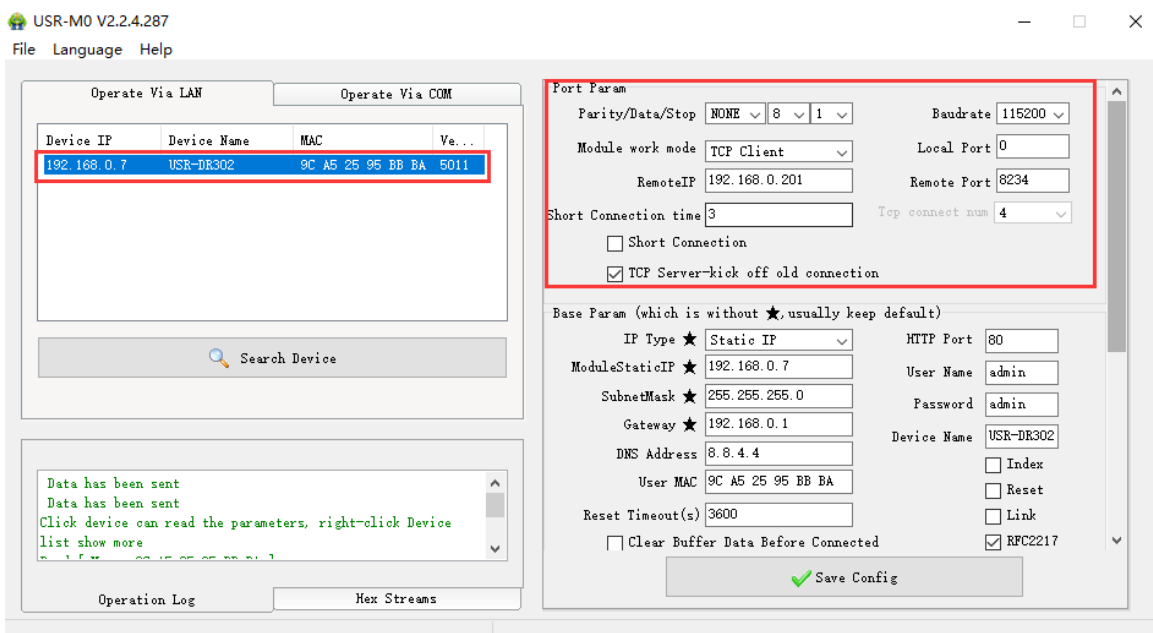

Diagram 6.1-3 Software Configuration-COM 1 Configuration

- Serial Baud rate: it can be standard or customized.
- Parity/Data/Stop: serial parameter.
- Work Mode: TCP Server /TCP Client/HTTPD Client/UDP Client/UDP Server
- Destination IP/Port: IP connected when USR-DR302 works as client (TCP Client/HTTPD Client/UDP Client)
- Local Port: The port number of DR302 be used to initiate the connection. Advice to set it to "0" when USR-DR302 works under TCP Client for connection with Random port.
- Similar RFC2217: Please refer to Chapter 3.5.10 Similar RFC2217

3. Firmware Upgrade

If USR-DR302 need to upgrade with new firmware, please contact USR sales.

During firmware upgrade, USR-DR302 connects to PC directly. PC Upgrade via Wi-Fi is prohibited.

Please refer to Chapter 4.1.5.

6.2. Webpage Configuration

Open browser and type in USR-DR302 ' IP (192.168.0.7 by default)

Then user name: admin and password: admin

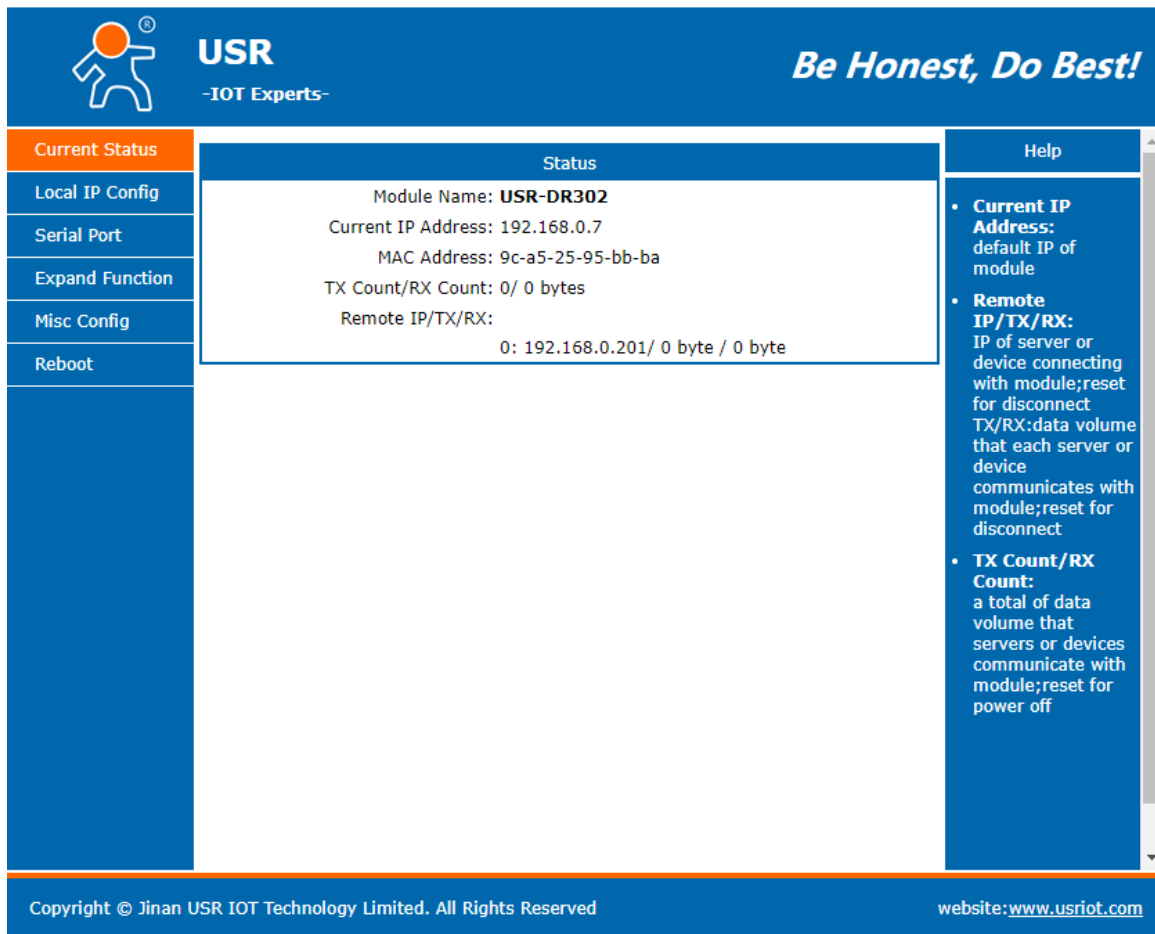

Current Status	Status	Help
Local IP Config	Module Name: USR-DR302	<ul style="list-style-type: none"> • Current IP Address: default IP of module • Remote IP/TX/RX: IP of server or device connecting with module;reset for disconnect TX/RX:data volume that each server or device communicates with module;reset for disconnect • TX Count/RX Count: a total of data volume that servers or devices communicate with module;reset for power off
Serial Port	Current IP Address: 192.168.0.7	
Expand Function	MAC Address: 9c-a5-25-95-bb-ba	
Misc Config	TX Count/RX Count: 0/ 0 bytes	
Reboot	Remote IP/TX/RX: 0: 192.168.0.201/ 0 byte / 0 byte	

Copyright © Jinan USR IOT Technology Limited. All Rights Reserved website:www.usriot.com

Diagram 6.2-1 Catalog

1. Current Status - reveals basic information:

- Module name

- Current IP address
 - MAC address
 - Total amount of data sent and received by all connections
 - The IP address of the connected device and the amount of data sent and received for each connection
2. Local IP Config
 Save configuration after revising the parameters. Then restart.

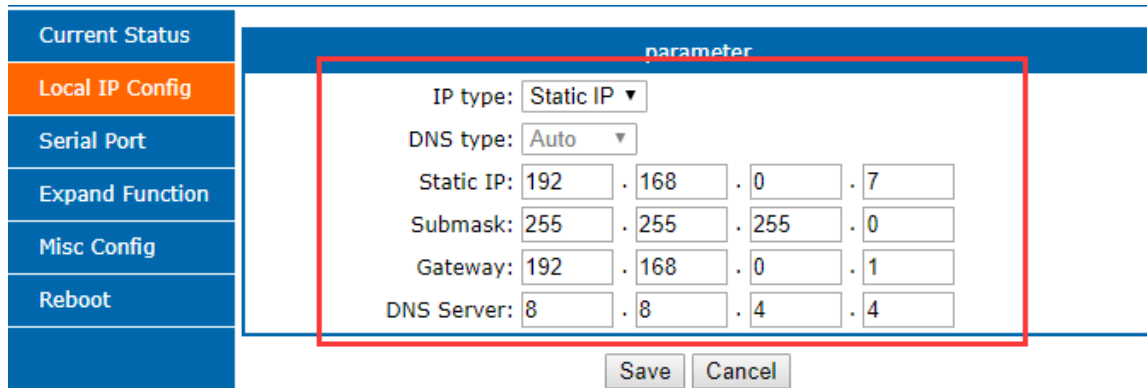

Current Status	parameter
Local IP Config	IP type: Static IP DNS type: Auto Static IP: 192 . 168 . 0 . 7 Submask: 255 . 255 . 255 . 0 Gateway: 192 . 168 . 0 . 1 DNS Server: 8 . 8 . 4 . 4
Serial Port	
Expand Function	
Misc Config	
Reboot	

Save Cancel

Diagram 6.2-2 Webpage Configuration-Local IP Configuration

3. Port parameters

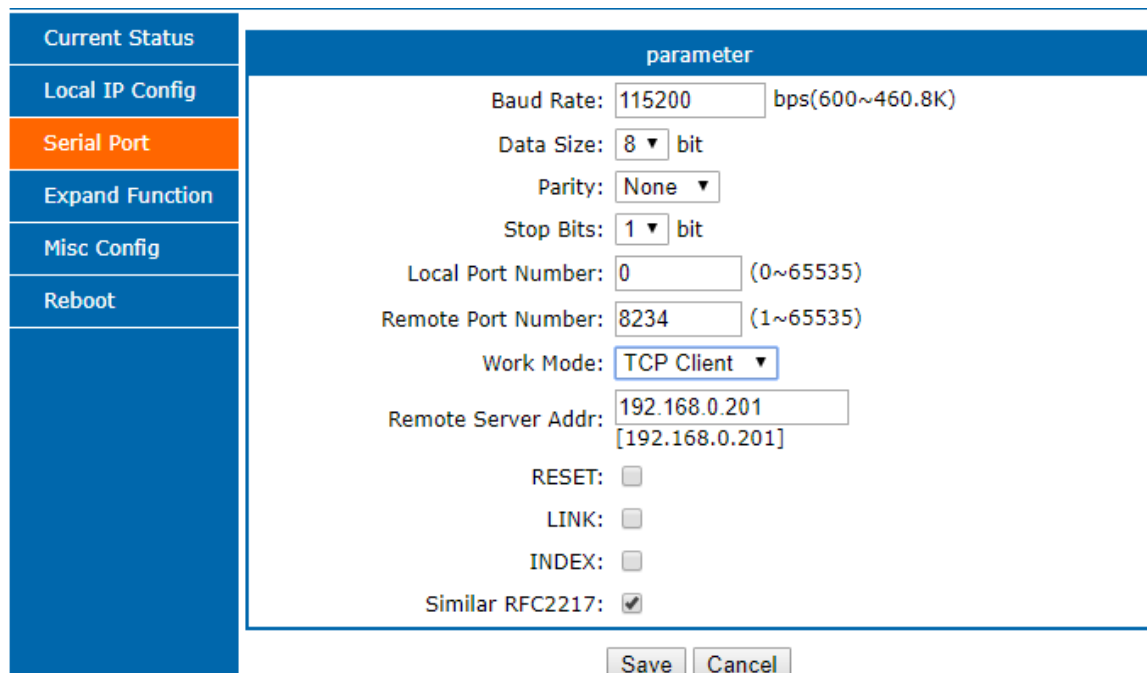

Current Status	parameter
Local IP Config	
Serial Port	Baud Rate: 115200 bps(600~460.8K) Data Size: 8 bit Parity: None Stop Bits: 1 bit Local Port Number: 0 (0~65535) Remote Port Number: 8234 (1~65535) Work Mode: TCP Client Remote Server Addr: 192.168.0.201 [192.168.0.201] RESET: <input type="checkbox"/> LINK: <input type="checkbox"/> INDEX: <input type="checkbox"/> Similar RFC2217: <input checked="" type="checkbox"/>
Expand Function	
Misc Config	
Reboot	

Save Cancel

Diagram 6.2-3 Basic Parameters

4. Expand Function
- USR-cloud ID and code
 - Custom heartbeat package function: can be opened by webpage, content customization, up to 40 bytes Buffer data before connected: whether serial and network data are cached if disconnection.
 - Customize the registration package function: can be opened through the webpage, the content is customized, the maximum length is 40 bytes, and the registration package is customized.
 - Impersistent Connection: Enable this function in TCP Client mode, short connection disconnection time

customization

- Buffer Data Before Connected: You can set whether to clear the cached data before the connection.
- New connection in TCP Server mode kicks off old connection function
- UART Set Parameter: The function of setting parameters through the serial port protocol can be enabled through the webpage.
- Modbus TCP: Disable by default.

Current Status	parameter
Local IP Config	
Serial Port	
Expand Function	
Misc Config	
Reboot	

Heartbeat Packet Type:

Register Packet Type:

Impersistent Connection:

Disconnect Time: (s)(2~255)

TCP Server-kick off old connection:

Buffer Data Before Connected:

UART Set Parameter:

Modbus TCP:

Diagram 6.2-4 Expand Function

5. Misc Config

Save all data then click restart to take effect.

Current Status	parameter
Local IP Config	
Serial Port	
Expand Function	
Misc Config	
Reboot	

Module Name:

Webserver Port:

Username:

Password:

Max Clients Connect To TCP Server: (1~8)

Reset Timeout: (s)(0,60~65535)

Diagram 6.2-5 Misc Config

6.3 AT Command Details

1. AT+E

Function: query/ setting module echo of the AT command setting

Format: query:

A+E<CR>

<CR><LF>+OK=< on/off ><CR><LF>

Setting:

A+E=< on/off ><CR>

<CR><LF>+OK<CR><LF>

Parameters: ON: enable the echo, echo the command entered by the AT command.

OFF: under AT command mode, the entered command do not echo.

E. g.: AT+E=on

2. AT+Z

Function: restart module

Format: setting:

AT+Z<CR>

<CR><LF>+OK<CR><LF>

Parameters: none

<note>: after perform this command correctly, module restart and exit the AT command mode.

3. AT+VER

Function: query module firmware version.

Format: query:

AT+VER<CR>

<CR><LF>+OK=< ver ><CR><LF>

Parameters: ver: query module firmware version.

4. AT+ENTM

Function: exit the AT command mode and enter the transparent transmission:

Format: setting:

AT+ENTM<CR>

<CR><LF>+OK<CR><LF>

Parameters: none

<note>: after perform this command correctly, module change into command mode from transparent transmission mode.

5. AT+RELD

Function: module reset

Format: setting

AT+RELD<CR>

<CR><LF>+OK<CR><LF>

Parameters: none.

6. AT+MAC

Function: query module MAC

Format: query:

AT+MAC<CR>

```
<CR><LF>+OK=< MAC ><CR><LF>
```

Parameters: mac: MAC address of the module(e.g.00020K2050A)

7. AT+WEBU

Function: setting /query module username and password

Format: query:

```
AT+WEBU<CR>
<CR><LF>+OK=< username,password ><CR><LF>
```

setting:

```
AT+WEBU=< username,password ><CR>
<CR><LF>+OK<CR><LF>
```

Parameters: username: username, support 5 bytes at longest and can not be none:

password: password, support 5 bytes at longest.

E.g.: AT+WEBU=admin,admin

8. AT+WANN

Function: setting /query the IP of WAN(DHCP/STATIC) that module access

Format: query:

```
AT+WANN<CR>
<CR><LF>+OK=< mode,address,mask,gateway ><CR><LF>
```

setting:

```
AT+WANN=< mode,address,mask,gateway ><CR>
<CR><LF>+OK<CR><LF>
```

Parameters: mode: web IP mode (static/DHCP)

static: static IP/

DHCP: dynamic IP(address,mask,gateway parameters ignore)

Address: IP address

Mask: subnet masks

Gateway: gateway address

E.g.: AT+WANN=static,192.168.0.7,255.255.255.0,192.168.0.1

9. AT+DNS

Function: setting /query DNS server address:

Format: query:

```
AT+DNS<CR>
<CR><LF>+OK=< address ><CR><LF>
```

setting:

```
AT+DNS=< address ><CR>
<CR><LF>+OK<CR><LF>
```

Parameters: address: DNS server address(default value is 8.8.8.8).

E.g.: AT+DNS=8.8.8.8

10. AT+WEBPORT

Function: setting /query webpage port

Format: query:

```
AT+WEBPORT<CR>
<CR><LF>+OK=< port ><CR><LF>
```

setting:

```
AT+WEBPORT=< port ><CR>
<CR><LF>+OK<CR><LF>
```

Parameters: port: module the port of the web server that built in of module. default 80:

F. g.: AT+WEBPORT=80

11. AT+UART

Function: setting /query UART interface parameters

Format: query:

```
AT+UART<CR>
<CR><LF>+OK=< baudrate,data_bits,stop_bit,parity,flowctrl ><CR><LF>
```

setting:

```
AT+UART=< baudrate,data_bits,stop_bit,parity,flowctrl ><CR><LF>
<CR><LF>+OK<CR><LF>
```

Parameters: baudrate: baud rate 600~460800bps, can be customized .

data_bits: data 5/6/7/8

stop_bits: stop 1/2

parity: parity

- ◆ NONE(no parity)
- ◆ EVEN(even parity)
- ◆ ODD(odd parity)
- ◆ MASK(1 parity)
- ◆ SPACE(0 parity)

flowctrl: flow control(none flow control , can not setting , default setting to be the NFC)

- ◆ NFC: none: hardware flow control

E.g.: AT+UART=115200,8,1,NONE,NFC

12. AT+SOCK

Function: setting /query web protocol parameters format

Format: query:

```
AT+SOCK<CR>
<CR><LF>+OK=< protocol,IP,port ><CR><LF>
```

setting:

```
AT+SOCK=< protocol,IP,port ><CR>
<CR><LF>+OK<CR><LF>
```

Parameters:

Protocol: protocol type, including

- ◆ TCPS is TCP server
- ◆ TCPC is TCP client
- ◆ UDPS is UDP server
- ◆ UDPC is UDP client
- ◆ HTPC is Httpd Client

IP: when the module setting into "CLIENT" mode, the IP address and domain name of the remote server.

Port: local port under Server mode and remote port under Client mode, decimal number and less than 65535.

E.g.: AT+SOCK=TCPC,192.168.0.201,8234

13. AT+TCPSE

Function: module is TCP Server, the processing mechanism after the connection reaches the maximum number of connections.

Format: query:

```
AT+TCPSE<CR>
<CR><LF>+OK=< status ><CR><LF>
```

setting:

```
AT+TCPSE=< status ><CR>
<CR><LF>+OK<CR><LF>
```

Parameters:

Status: setting status keep/kick

- ◆ keep: after reach the maximum number of connection, do not receive new one.
- ◆ kick: after reach the maximum number of connection, delete the order one and connect the new one.

E.g.: AT+TCPSE=keep

14. AT+SOCKLK

Function: query whether the TCP has connected

Format: query:

```
AT+ SOCKLK<CR>
<CR><LF>+OK=< sta ><CR><LF>
```

Parameters:

Sta: built the TCP connection or not

- ◆ Connect: TCP connected
- ◆ Disconnect: TCP not connected

15. AT+SOCKPORT

Function: setting /query local socket port

Format: query:

```
AT+SOCKPORT<CR>
<CR><LF>+OK=< sta ><CR><LF>
```

setting:

```
AT+ SOCKPORT =< sta ><CR>
<CR><LF>+OK<CR><LF>
```

Parameters:

- ◆ Sta: 0 is using port randomly. 1-65535 is using the local port of the socket.

E.g.: AT+SOCKPORT=20108:

16. AT+RFCEN

Function: enable/ disable RFC2217function

Format: query:

```
AT+RFCEN<CR>
<CR><LF>+OK=< status ><CR><LF>
```

setting:

```
AT+RFCEN =< status ><CR>
<CR><LF>+OK<CR><LF>
```

Parameters:

Status:

- ◆ ON: enable RFC2217function
- ◆ OFF: disable RFC2217function

E.g.: AT+RFCEN=ON

17. AT+PDTIME

Function: query produce time

Format: query:

```
AT+PDTIME<CR>
<CR><LF>+OK=< time ><CR><LF>
```

Parameters:

time: produce time,

E.g.: 2016-10-18 11:20:02

18. AT+REGEN

Function: setting query registration package mechanism

Format: query:

```
AT+REGEN<CR>
<CR><LF>+OK=< status ><CR><LF>
```

setting:

```
AT+REGEN =< status ><CR>
<CR><LF>+OK<CR><LF>
```

Parameters:

Status:

- ◆ MAC: enable registration package mechanism, registration package is 6 bites MAC
- ◆ Usr: customize registration package
- ◆ Off: disable registration package mechanism

E.g.: AT+REGEN=MAC

19. AT+REGTCP

Function: setting query tcp client mode registration package perform mechanism

Format: query:

```
AT+REGTCP<CR>
<CR><LF>+OK=< status ><CR><LF>
```

setting:

```
AT+REGTCP =< status ><CR>
<CR><LF>+OK<CR><LF>
```

Parameters:

Status:

- ◆ first: send a registration package when connected the server at first time
- ◆ every: add a registration package in front of the every data package sent to server.
- ◆ all: send registration package when first connected to the server and add registration package in front of the data package.

E.g.: AT+REGTCP=first

20. AT+REGCLOUD

Function: setting /query USR-cloud username and password

Format: query:

```
AT+REGCLOUD<CR>
<CR><LF>+OK=< name, password ><CR><LF>
```

setting:

```
AT+REGCLOUD=< name, password ><CR>
<CR><LF>+OK<CR><LF>
```

Parameters:

Status:

- ◆ name: USR-cloud device port:
- ◆ password: USR-cloud password .

E.g.: AT+REGCLOUD=000000000000000000000000, 00000000

21. AT+REGUSR

Function: setting query customize registration package content

Format: query:

```
AT+REGUSR<CR>
<CR><LF>+OK=< data ><CR><LF>
```

setting:

```
AT+ REGUSR =< data ><CR>
<CR><LF>+OK<CR><LF>
```

Parameters:

data: ASCII code in 40 bytes

E.g.: AT+REGUSR=www.usr.cn

22. AT+HTPTP

Function: setting /query the asking way under HTTPD Client mode.

Format: query:

```
AT+HTPTP<CR>
<CR><LF>+OK=< status ><CR><LF>
```

setting:

```
AT+HTPTP =< status ><CR>
<CR><LF>+OK<CR><LF>
```

Parameters:

Status:

- ◆ GET: is the http asking way
- ◆ POST: is the http asking way

E.g.: AT+HTPTP=GET

23. AT+HTPURL

Function: setting /query the URL. Of the post

Format: query:

```
AT+HTPURL<CR>
<CR><LF>+OK=< URL ><CR><LF>
```

setting:

```
AT+HTPURL =< URL ><CR>
<CR><LF>+OK<CR><LF>
```

Parameters:

URL: start with “/”, less than 99 bytes .

E.g.: AT+HTPURL=/2.php

24. AT+HTPHEAD

Function: setting /query Httpd Client customize package head message

Format: query:

```
AT+HTPHEAD<CR>
<CR><LF>+OK=< data ><CR><LF>
```

setting:

```
AT+ HTPHEAD =< data ><CR>
<CR><LF>+OK<CR><LF>
```

Parameters:

- ◆ data: customize package message, less than 199 bytes. And using <<CRLF>> translating the characters in stead of the enter.

E.g.: AT+HTPHEAD=Accept:text<<CRLF>>

25. AT+HTPCHD

Function: setting /query filter the package head of the return information of Http

Format: query:

```
AT+ HTPCHD <CR>
```

```
<CR><LF>+OK=< sta ><CR><LF>
```

setting:

```
AT+ HTPCHD =< sta ><CR>
<CR><LF>+OK<CR><LF>
```

Parameters: Sta:

- ◆ ON: enable
- ◆ OFF: disable

E.g.: AT+HTPCHD=ON

26. AT+HEARTEN

Function: setting /query enable or not heartbeat package

Format: query:

```
AT+ HEARTEN <CR>
<CR><LF>+OK=< status ><CR><LF>
```

setting:

```
AT+ HEARTEN =< status ><CR>
<CR><LF>+OK<CR><LF>
```

Parameters:

Status:

- ◆ ON:enable heartbeat package
- ◆ Off: disable heartbeat package

E.g.: AT+HEARTEN=ON

27. AT+HEARTTP

Function: setting /query heartbeat package send way

Format: query:

```
AT+ HEARTTP <CR>
<CR><LF>+OK=< type ><CR><LF>
```

setting:

```
AT+ HEARTTP =< type ><CR>
<CR><LF>+OK<CR><LF>
```

Parameters:

Status:

- ◆ NET: send heartbeat package to server
- ◆ COM: send heartbeat package to serial port

E.g.: AT+HEARTTP=NET

28. AT+HEARTTM

Function: setting /query time of heartbeat package

Format: query:

```
AT+ HEARTTM <CR>
<CR><LF>+OK=< time ><CR><LF>
```

setting:

```
AT+ HEARTTM =< time ><CR>
<CR><LF>+OK<CR><LF>
```

Parameters:

Time: heartbeat time ,default is 30s, range from 1 to 65535s.

E.g.: AT+HEARTTM=30

29. AT+HEARTDT

Function: setting query customize heartbeat package content

Format: query:

```
AT+ HEARTDT <CR>
<CR><LF>+OK=< data ><CR><LF>
```

setting:

```
AT+ HEARTDT =< data ><CR>
<CR><LF>+OK<CR><LF>
```

Parameters:

data: less than 40 bytes ASCII code.

E.g.: AT+HEARTDT=www.usr.cn.

30. AT+ SCSLINK

Function: setting /query Socket connected status instructions function (connection status instructions pin change or not according to the connection status)

Format: query:

```
AT+ SCSLINK <CR>
<CR><LF>+OK=< sta ><CR><LF>
```

setting:

```
AT+ SCSLINK =< sta ><CR>
<CR><LF>+OK<CR><LF>
```

Parameters: sta: status

ON: enable link function

OFF: disable link function

E.g.: AT+ SCSLINK=ON

31. AT+ CLIENTRST

Function: setting /query TCP Client mode filed to connect several time and reset (repeat 30 times connection failed, module restart)

Format: query:

```
AT+ CLIENTRST <CR>
<CR><LF>+OK=< sta ><CR><LF>
```

setting:

```
AT+ CLIENTRST =< sta ><CR>
<CR><LF>+OK<CR><LF>
```

Parameters: sta: status

ON: enable TCP Client reset function

OFF: disable TCP Client reset function

E.g.: **AT+CLIENTRST =ON**

32. AT+ INDEXEN

Function: setting /query index function

Format: query:

```
AT+ INDEXEN <CR>
<CR><LF>+OK=< sta ><CR><LF>
```

setting:

```
AT+ INDEXEN =< sta ><CR>
<CR><LF>+OK<CR><LF>
```

Parameters: sta: status

ON: enable **index** function

OFF: disable **index** function

E.g.: **AT+INDEX=ON**

33. AT+ SOCKSL

Function: setting /query short connection function

Format: query:

```
AT+ SOCKSL <CR>
<CR><LF>+OK=< sta ><CR><LF>
```

setting:

```
AT+ SOCKSL =< sta ><CR>
<CR><LF>+OK<CR><LF>
```

Parameters: sta: status

ON: enable **short connection** function

OFF: disable short connection function

E.g.: **AT+SOCKSL =ON**

34. AT+ SHORTO

Function: setting /query short connection time

Format: query:

```
AT+ SHORTO <CR>
<CR><LF>+OK=< time ><CR><LF>
```

setting:

```
AT+ SHORTO =< time ><CR>
<CR><LF>+OK<CR><LF>
```

Parameters: time: short connection time, 2-255s

E.g.: **AT+SHORTO =3**

35. AT+ UARTCLBUF

Function: setting /query if the module clear the serial port cache before connected

Format: query:

```
AT+ UARTCLBUF <CR>
<CR><LF>+OK=< sta ><CR><LF>
```

setting:

```
AT+ UARTCLBUF =< sta ><CR>
<CR><LF>+OK<CR><LF>
```

Parameters: sta: status

ON: clear the serial port cache before connected

OFF: do not clear the serial port cache before connected

E.g.: AT+UARTCLBUF =ON

36. AT+ RSTIM

Function: setting /query restart out time

Format: query:

```
AT+ RSTIM <CR>
<CR><LF>+OK=< time ><CR><LF>
```

setting:

```
AT+ RSTIM =< time ><CR>
<CR><LF>+OK<CR><LF>
```

Parameters: time: short connection time: 0, 60-65535s

E.g.: AT+RSTIM =3600

37. AT+ MAXSK

Function: setting /query the maximum number of the client that TCP Server connected **Format: query:**

```
AT+ MAXSK <CR>
<CR><LF>+OK=< num ><CR><LF>
```

setting:

```
AT+ MAXSK =< num ><CR>
<CR><LF>+OK<CR><LF>
```

Parameters: num: the maximum number of the client that TCP Server connected, range from 1 to 16

E.g.: AT+MAXSK =4

38. AT+ MID

Function: setting /query module name

Format: query:

```
AT+ MID <CR>
<CR><LF>+OK=< name ><CR><LF>
```

setting:

```
AT+ MID =< name ><CR>
<CR><LF>+OK<CR><LF>
```

Parameters: name: module name, maximum 15 bytes and can not be none.

E.g.: AT+MID =USR-DR302

39. AT+ MODTCP

Function: query/ setting modbus TCP function

Format: query

```
AT+ MODTCP<CR>
<CR><LF>+OK=< sta ><CR><LF> >
```

Parameters: sta: help information

40. AT+ H

Function: help

Format: query:

```
AT+ H <CR>
<CR><LF>+OK=< sta ><CR><LF>
```

Parameters: sta: help information

7. Contact

Company: Jinan USR IOT Technology Limited

Address: Floor 11,Building1,No.1166 Xinluo Street,Gaoxin Distric,Jinan,Shandong,250101 China

Tel: 86-531-55507297, 86-531-88826739

Web: <http://www.usriot.com>

Support : <http://h.usriot.com>

Email: sales@usriot.com

8. Disclaimer

This document provide the information of USR-DR302 products, it hasn't been granted any intellectual property license by forbidding speak or other ways either explicitly or implicitly. Except the duty declared in sales terms and conditions, we don't take any other responsibilities. We don't warrant the products sales and use explicitly or implicitly, including particular purpose merchantability and marketability, the tort liability of any other patent right, copyright, intellectual property right. We may modify specification and description at any time without prior notice.

9. Update History

2019-08-22 V 1.0.0 Created