

User's Manual

FNSW-2400PS

**24-Port 10/100Mbps
POE Web Smart Ethernet Switch**



Trademarks

Copyright © PLANET Technology Corp. 2011.

Contents subject to revision without prior notice.

PLANET is a registered trademark of PLANET Technology Corp. All other trademarks belong to their respective owners.

Disclaimer

PLANET Technology does not warrant that the hardware will work properly in all environments and applications, and makes no warranty and representation, either implied or expressed, with respect to the quality, performance, merchantability, or fitness for a particular purpose.

PLANET has made every effort to ensure that this User's Manual is accurate; PLANET disclaims liability for any inaccuracies or omissions that may have occurred.

Information in this User's Manual is subject to change without notice and does not represent a commitment on the part of PLANET. PLANET assumes no responsibility for any inaccuracies that may be contained in this User's Manual. PLANET makes no commitment to update or keep current the information in this User's Manual, and reserves the right to make improvements to this User's Manual and/or to the products described in this User's Manual, at any time without notice.

If you find information in this manual that is incorrect, misleading, or incomplete, we would appreciate your comments and suggestions.

FCC Warning

This equipment has been tested and found to comply with the limits for a Class A digital device, pursuant to Part 15 of the FCC Rules. These limits are designed to provide reasonable protection against harmful interference when the equipment is operated in a commercial environment. This equipment generates, uses, and can radiate radio frequency energy and, if not installed and used in accordance with the Instruction manual, may cause harmful interference to radio communications. Operation of this equipment in a residential area is likely to cause harmful interference in which case the user will be required to correct the interference at his own expense.

CE Mark Warning

This is a Class A product. In a domestic environment, this product may cause radio interference, in which case the user may be required to take adequate measures.

Energy Saving Note of the Device

This power required device does not support Standby mode operation.

For energy saving, please remove the power cable to disconnect the device from the power circuit.

Without removing power cable, the device will still consuming power from the power source. In the view of Saving the Energy and reduce the unnecessary power consuming, it is strongly suggested to remove the power connection for the device if this device is not intended to be active.

WEEE Warning



To avoid the potential effects on the environment and human health as a result of the presence of hazardous substances in electrical and electronic equipment, end users of electrical and electronic equipment should understand the meaning of the crossed-out wheeled bin symbol. Do not dispose of WEEE as unsorted municipal waste and have to collect such WEEE separately.

Revision

PLANET 24-Port 10/100Mbps POE Web Smart Ethernet Switch User's Manual

FOR MODEL: FNSW-2400PS

REVISION: 1.1(OCTOBER.2011)

Part No.: 2081-A81180-001

TABLE OF CONTENTS

1. INTRODUCTION	6
1.1 CHECKLIST	6
1.2 ABOUT THE SWITCH	6
1.3 FEATURES	7
1.4 SPECIFICATION	8
2. HARDWARE DESCRIPTION	10
2.1 FRONT PANEL	10
2.1.1 LED Indicators.....	10
2.2 REAR PANEL	10
2.3 HARDWARE INSTALLATION	11
2.3.1 Desktop Installation.....	11
2.3.2 Rack Mounting	12
3. SWITCH MANAGEMENT	14
3.1 OVERVIEW	14
3.2 MANAGEMENT METHOD	14
3.2.1 Web Management.....	14
3.3 LOGGING ON TO THE FNSW-2400PS	15
4. WEB MANAGEMENT	16
4.1 LOGIN IN TO THE SWITCH	16
4.2 ADMINISTRATOR.....	17
4.2.1 System Information	18
4.2.2 IP Configuration	19
4.2.3 Password Setting	20
4.2.4 Factory Default.....	20
4.2.5 Firmware Update	21
4.2.6 Reboot.....	22
4.3 PORT MANAGEMENT	23
4.3.1 Port Configuration	24
4.3.2 Port Mirroring	25
4.3.3 Bandwidth Control.....	26
4.3.4 Broadcast Storm Control.....	27
4.3.5 Port Statistics	27
4.4 VLAN SETTING.....	29
4.4.1 VLAN Mode.....	32
4.4.1.1 Port Base VLAN Mode.....	33
4.4.1.2 Tag Base VLAN Mode	33
4.4.2 VLAN Member.....	34
4.4.3 Multi to 1 Setting	36

4.5 QoS SETTING.....	37
4.5.1 Priority Mode.....	37
4.5.2 Class of Service.....	38
4.6 SECURITY.....	41
4.6.1 MAC Address Binding.....	42
4.6.2 TCP / UDP Scan.....	43
4.6.3 TCP / UDP Filter.....	43
4.6.4 IP Address Filter.....	45
4.7 SPANNING TREE.....	46
4.7.1 STP Bridge Settings.....	47
4.7.2 STP Port Settings.....	48
4.7.3 Loopback Detection Settings.....	50
4.8 TRUNKING.....	51
4.9 DHCP RELAY AGENT.....	53
4.9.1 DHCP Relay Agent.....	54
4.9.2 Relay Server.....	55
4.9.3 VLAN MAP Relay Agent.....	55
4.10 BACKUP/RECOVERY.....	56
4.11 MISCELLANEOUS.....	57
4.11.1 Miscellaneous Settings.....	57
4.11.2 IGMP Static Router Settings.....	58
4.12 SNMP SETTINGS.....	59
4.13 SAVE SETTINGS.....	60
4.14 LOGOUT.....	60
5. SWITCH OPERATION.....	61
5.1 ADDRESS TABLE.....	61
5.2 LEARNING.....	61
5.3 FORWARDING & FILTERING.....	61
5.4 STORE-AND-FORWARD.....	61
5.5 AUTO-NEGOTIATION.....	62
6. POWER OVER ETHERNET OVERVIEW.....	63
7. THE POE PROVISION PROCESS.....	65
7.1 LINE DETECTION.....	65
7.2 CLASSIFICATION.....	65
7.3 START-UP.....	66
7.4 OPERATION.....	66
7.5 POWER DISCONNECTION SCENARIOS.....	66

8. TROUBLESHOOTING..... 67

APPENDIX A NETWORKING CONNECTION..... 68

A.1 SWITCH'S RJ-45 PIN ASSIGNMENTS 68

A.2 RJ-45 CABLE PIN ASSIGNMENT 68

A.3 DATA OUT PoE INJECTOR RJ-45 PORT PIN ASSIGNMENTS 69

1. INTRODUCTION

1.1 Checklist

Check the contents of your package for following parts:

- FNSW-2400PS x1
- Quick Installation Guide x1
- User's Manual CD x1
- Power Cord x 1
- Rubber Feet x 4
- Two Rack-mounting Brackets with Attachment Screws x1

If any of these pieces are missing or damaged, please contact your dealer immediately, if possible, retain the carton including the original packing material, and use them against to repack the product in case there is a need to return it to us for repair.

In the following section, the term “**POE Web Smart Ethernet Switch**” means the Switch device, ie. FNSW-2400PS; term of “**switch**” can be any third switches.

1.2 About the Switch

The FNSW-2400PS provides 24 10/100Mbps POE Fast Ethernet ports, the Web Smart PoE Switch supports MDI / MDI-X convertible on 24 10/100Mbps ports and also provides PoE inject function on port#1 to port#24 which is able to drive at least 8 IEEE 802.3af 15.4Watts compliant powered devices.

The unshielded twisted-pair (UTP) cable ports providing dedicated 10/100Mbps bandwidth, the dual speed ports used standard twisted-pair cabling and are ideal for SOHO or segmenting networks into small. Each 10/100Mbps port can supports up to 200Mbps of throughput in full-duplex mode, the POE Web Smart Ethernet Switch also provides a simple, cost-effective, and highly reliable network connection for data as well as power. Furthermore, it is the ideal device for bridging among Ethernet, Fast Ethernet workgroups and networks.

The FNSW-2400PS equipped with non-blocking 4.8Gbps backplane, greatly simplifies the tasks of upgrading your LAN for catering to increase bandwidth demands.

For efficient management, the FNSW-2400PS is equipped with remote Web interface. The Web Smart PoE Switch can be programmed for advanced switch management functions such as SNMP , port configuration, port-based / IEEE 802.1Q / MTU VLAN, port mirroring, port trunk, QoS, bandwidth control, broadcast storm control, MAC address / TCP & UDP filter and IGMP Snooping v1/v2.

1.3 Features

➤ Physical Port

- 24-Port 10/100Mbps Fast Ethernet ports with PoE Injector
- Reset button for system management

➤ PoE

- Complies with IEEE 802.3af Power over Ethernet Mid-Span PSE
- Up to 24 IEEE 802.3af devices powered
- Supports PoE Power up to 15.4 Watts for each 802.3af PoE port
- Auto detect powered device (PD)
- Circuit protection prevents power interference between ports
- Remote power feeding up to 100m

➤ Layer 2 Features

- Auto-MDI/MDI-X detection on each RJ-45 port
- Prevents packet loss with back pressure (Half-Duplex) and IEEE 802.3x PAUSE Frame Flow control (Full-Duplex)
- Support **VLAN**:
 - IEEE 802.1Q Tag-based VLAN
 - Port-Based VLAN
 - MTU VLAN (Multi-Tenant Unit VLAN)
- Support **Link Aggregation**
 - up to 2 trunk groups
 - up to 4 Fast Ethernet ports per trunk group
 - IEEE 802.3ad LACP (Link Aggregation Control Protocol)
- Support **Spanning Tree Protocol**
 - STP, IEEE 802.1D (Classic Spanning Tree Protocol)
 - RSTP, IEEE 802.1w (Rapid Spanning Tree Protocol)
 - Loopback Detection
- Port Mirroring to monitor the incoming or outgoing traffic on a particular port

➤ Quality of Service

- 2 priority queues on all switch ports
- Traffic classification:
 - Port-Based priority
 - IEEE 802.1p-Based priority
 - IP TOS / DSCP-Based priority
 - TCP / UDP Port Based QoS
- Strict priority and Weighted Round Robin (WRR) CoS policies
- In/Out rate limit control on each port
- Broadcast Storm Control support

➤ Multicast

- Supports IGMP Snooping v1 and v2

➤ Security

- MAC address filter
- TCP & UDP filter on each port

- Management idle time security

➤ **Management**

- Remote Web interface for Switch management and setup
- Supports SNMP v1
- Supports DHCP Option82 and DHCP Relay
- Firmware upgrade through Web interface
- Configuration upload / download through Web interface
- Reset button for system reboot or reset to factory default

1.4 Specification

Model	FNSW-2400PS
Hardware Specification	
Ports	24 10/100Base-TX RJ-45 Auto-MDI/MDI-X interfaces
Switch Processing Scheme	Store-and-Forward
Throughput (packet per second)	3.57Mpps@64Bytes
Switch Fabric	4.8Gbps
Address Table	8K entries
Share Data Buffer	1.75Mb embedded memory for packet buffers
Flow Control	Back pressure for Half Duplex, IEEE 802.3x Pause Frame for Full Duplex
Dimensions (W x D x H)	445 x 207 x 45 mm (1U height)
Weight	2.55kg
Power Requirement	100~240V AC, 50-60 Hz, 2A
Power Consumption / Dissipation	Max.135 Watts / 460 BTU
Smart Function	
System Configuration	Web interface, SNMP v1
Port Configuration	Port Speed Duplex mode selection Port Disable / Enable
Bandwidth Control	Yes
Broadcast Storm Control	Yes / Threshold 1~63
Port Statistics	Display each port's detail Ethernet traffic counter information
VLAN	24 Port-based VLAN groups 32 IEEE 802.1Q VLAN groups MTU VLAN
Spanning Tree Protocol	STP, IEEE 802.1D (Spanning Tree Protocol)

	RSTP, IEEE 802.1w (Rapid Spanning Tree Protocol)
Port Trunking	Support 2 groups of 4-Port 10/ 100Base-TX trunk support Up to 800Mbps bandwidth per trunk (Full-Duplex)
Port Mirroring	Port mirroring allows monitoring of the traffic across any port in real time
QoS	Allow to assign low / high priority on each port. First-In-First-Out, All-High-before-Low, Weight-Round-Robin QoS policy.
MAC Address / TCP & UDP Filter	Yes
IGMP Snooping v1 / v2	Allow to Disable or Enable.
Power over Ethernet	
PoE Standard	IEEE 802.3af Power over Ethernet / PSE
PoE Power Supply Type	Mid-Span
PoE Power output	Per Port 48V DC, 350mA . Max. 15.4 watts
Power Pin Assignment	4/5(-), 7/8(+)
PoE Power Budget	125Watts
Standards Conformance	
Regulation Compliance	FCC Part 15 Class A, CE
Standards Compliance	IEEE 802.3 Ethernet IEEE 802.3u Fast Ethernet IEEE 802.3af Power over Ethernet (15.4Watts) IEEE 802.3x Full-duplex flow control IEEE 802.1Q VLAN IEEE 802.1p QoS IEEE 802.1D Spanning Tree Protocol IEEE 802.1w Rapid Spanning Tree Protocol
Environment	
Temperature	Operating: 0~50 Degree C Storage: -10~70 Degree
Humidity Operating	5% to 95%, Storage: 5% to 95% (Non-condensing)

2. HARDWARE DESCRIPTION

This product provides two different running speeds – 10Mbps and 100Mbps in the same POE Web Smart Ethernet Switch and automatically distinguishes the speed of incoming connection.

This section describes the hardware features of FNSW-2400PS. For easier management and control of the FNSW-2400PS, familiarize yourself with its display indicators, and ports. Front panel illustrations in this chapter display the unit LED indicators. Before connecting any network device to the FNSW-2400PS, read this chapter carefully.

2.1 Front Panel

The Front Panel of the FNSW-2400PS consists of 24x Auto-Sensing 10/100Mbps Ethernet RJ-45 Ports. The LED Indicators are also located on the front panel of the POE Web Smart Ethernet Switch.



Figure 2-1: FNSW-2400PS Switch Front Panel

2.1.1 LED Indicators

■ System

LED	Color	Function	
PWR	Green	Lights	Indicate that the Switch has power.

■ Per 10/100Base-TX, PoE interfaces (Port-1 to Port-24)

LED	Color	Function	
LNK/ACT	Green	Lights:	Indicate the link through that port is successfully established.
		Blink:	Indicate the Switch is actively sending or receiving data over that port.
PoE In-Use	Orange	Lights:	Indicate the port is providing 48VDC in-line power.
		OFF:	Indicate the connected device is not a PoE Powered Device (PD).



1. Press the RESET button once. The POE Web Smart Ethernet Switch will reboot automatically.
2. Press the RESET button for 5 ~ 10 seconds. The POE Web Smart Ethernet Switch will back to the factory default mode; the entire configuration will be erased.

2.2 Rear Panel

The rear panel of the POE Web Smart Ethernet Switch indicates an AC inlet power socket, which accepts input power from 100 to 240VAC, 50-60Hz, 2A.



Figure 2-2: FNSW-2400PS Switch rear panel

Power Notice:

1. The device is a power-required device, it means, it will not work till it is powered. If your networks should active all the time, please consider using UPS (Uninterrupted Power Supply) for your device. It will prevent you from network data loss or network downtime.
2. In some area, installing a surge suppression device may also help to protect your POE Web Smart Ethernet Switch from being damaged by unregulated surge or current to the POE Web Smart Ethernet Switch.

2.3 Hardware Installation

This part describes how to install your POE Web Smart Ethernet Switch and make connections to the Switch. Please read the following topics and perform the procedures in the order being presented. To install your POE Web Smart Ethernet Switch on a desktop or shelf, simply completed the following steps.

2.3.1 Desktop Installation

To install POE Web Smart Ethernet Switch on a desktop or shelf, simply completed the following steps:

Step 1: Attached the rubber feet to the recessed areas on the bottom of the POE Web Smart Ethernet Switch.

Step 2: Place the POE Web Smart Ethernet Switch on a desktop or shelf near an AC power source.

Step 3: Keep enough ventilation space between the POE Web Smart Ethernet Switch and the surrounding objects.



When choosing a location, please keep in mind the environmental restrictions discussed in Chapter 1, Section 4, Specification.

Step 4: Connect your Switch to network devices.

- A. Connect one end of a standard network cable to the 10/100 RJ-45 ports on the front of the POE Web Smart Ethernet Switch.
- B. Connect the other end of the cable to the network devices such as printer servers, workstations or routers...etc.



Connection to the POE Web Smart Ethernet Switch requires UTP Category 5 or above cabling with RJ-45 tips. For more information, please see the Cabling Specification in **Appendix A**.

Step 5: Supply power to the POE Web Smart Ethernet Switch.

- A. Connect one end of the power cable to the POE Web Smart Ethernet Switch.
- B. Connect the power plug of the power cable to a standard wall outlet then power on the POE Web Smart Ethernet Switch.

When the POE Web Smart Ethernet Switch receives power, the Power LED should remain solid Green.

2.3.2 Rack Mounting

To install the POE Web Smart Ethernet Switch in a **19-inch** standard rack, follow the instructions described below.

Step 1: Place your POE Web Smart Ethernet Switch on a hard flat surface, with the front panel positioned towards your front side.

Step 2: Attach a rack-mount bracket to each side of the POE Web Smart Ethernet Switch with supplied screws attached to the package. [Figure 2-3](#) shows how to attach brackets to one side of the POE Web Smart Ethernet Switch.

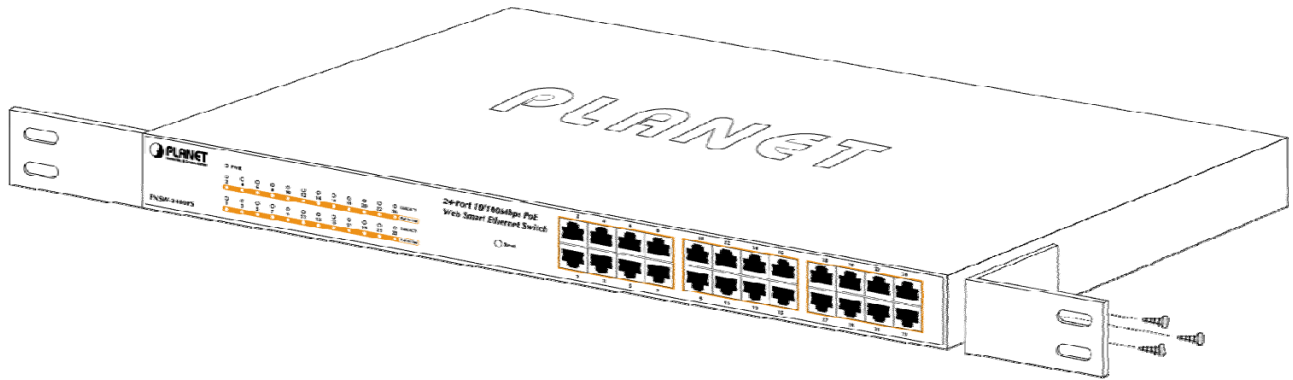

Figure 2-3 Attaching the brackets to the POE Web Smart Ethernet Switch



You must use the screws supplied with the mounting brackets. Damage caused to the parts by using incorrect screws would invalidate your warranty.

Step 3: Secure the brackets tightly.

Step 4: Follow the same steps to attach the second bracket to the opposite side.

Step 5: After the brackets are attached to the POE Web Smart Ethernet Switch, use suitable screws to securely attach the brackets to the rack, as shown in [Figure 2-4](#).

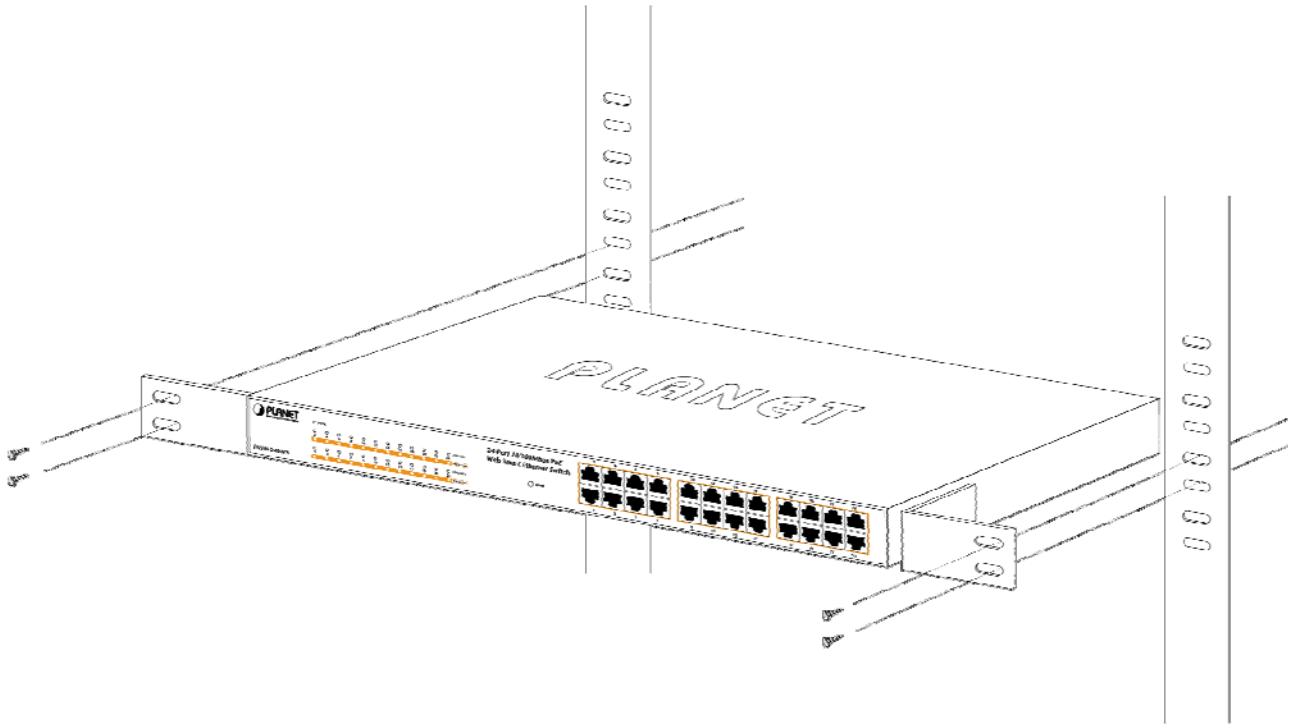

Figure 2-4 Mounting the POE Web Smart Ethernet Switch in a Rack

Step 6: Precede with the steps 4 and steps 5 of section **2.3.1 Desktop Installation** to connect the network cabling and supply power to your POE Web Smart Ethernet Switch.

3. SWITCH MANAGEMENT

This chapter describes how to manage the POE Web Smart Ethernet Switch. Topics include:

- Overview
- Management method
- Logging on to the POE Web Smart Ethernet Switch

3.1 Overview

The POE Web Smart Ethernet Switch provides a user-friendly, Web interface. Using this interface, you can perform various switch configuration and management activities, including:

Please refer to the following Chapter 4 for the details.

3.2 Management Method

User can manage the POE Web Smart Ethernet Switch by Web Management via a network connection.

3.2.1 Web Management

The PLANET FNSW-2400PS provide a built-in browser interface. You can manage the Switch remotely by having a remote host with Web browser, such as Microsoft Internet Explorer, Netscape Navigator or Mozilla Firefox.

The following shows how to startup the Web Management of the Switch, please note the Switch is configured through an Ethernet connection, make sure the manager PC must be set on the same IP subnet address, for example, the default IP address of the Switch is **192.168.0.100** (the factory-default IP address), then the manager PC should be set on 192.168.0.xxx (where x is a number between 1 and 254, except 100), and the default subnet mask is 255.255.255.0.

Use Internet Explorer 7.0 or above Web browser, enter default IP address <http://192.168.0.100>

After entering the username and password (default user name and password is “**admin**”) in login screen

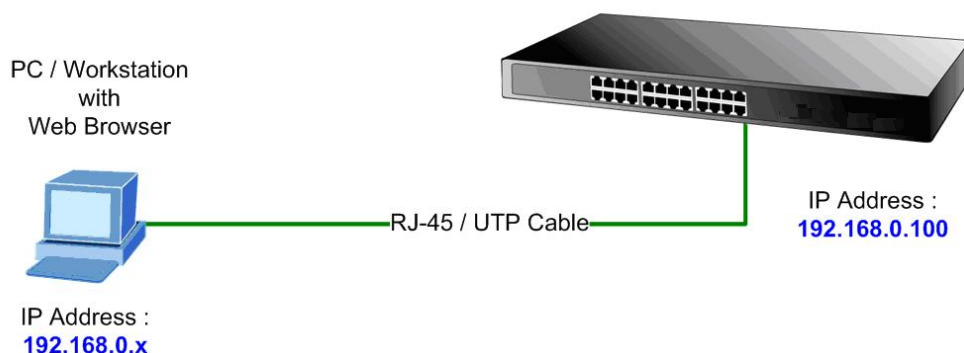

Default IP : **192.168.0.100**
 Default Username: **admin**
 Default Password: **admin**

3.3 Logging on to the FNSW-2400PS

When you log on to the POE Web Smart Ethernet Switch Web interface for the first time, a sign-on string appears and you are prompted for a Web login username and password. The factory default login username and password is **admin**.



Figure 3-1 POE Web Smart Ethernet Switch Web Login Screen



For security reason, please change and memorize the new password after this first setup.

4. WEB MANAGEMENT

To modify your PC's IP domain to the same with POE Web Smart Ethernet Switch then use the default IP address (192.168.0.100) to remote configure POE Web Smart Ethernet Switch through the **Web** interface.

4.1 Login in to the Switch

To access the Web-browser interface you must first enter the user name and password, the default user name and password is "admin". You will see the following screen [Figure 4-1](#) comes out on the Web browser program:



Figure 4-1 Web Login Screen

After the User name and Password is entered, you will see the Web Main Menu screen. The Switch Menu provide seven major management functions, the screen in [Figure 4-2](#) appears.

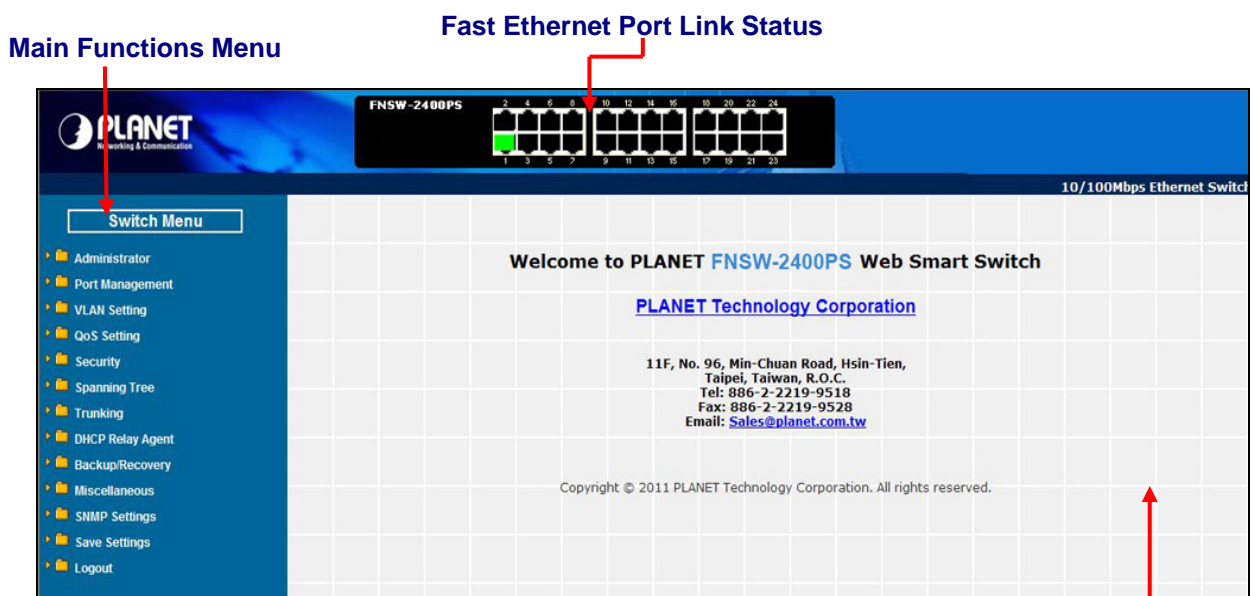

Figure 4-2 Web Main Menu Screen

Main Screen

The seven items and its description shown as below:

- ◆ **Administrator:** Provide System configuration of POE Web Smart Switch. [Explained in section 4.2.](#)
- ◆ **Port Management:** Provide Port Management configuration of POE Web Smart Switch. [Explained in section 4.3.](#)
- ◆ **VLAN Setting:** Provide VLAN Setting configuration of POE Web Smart Switch. [Explained in section 4.4.](#)
- ◆ **QoS Setting:** Provide QoS Setting configuration of POE Web Smart Switch. [Explained in section 4.5.](#)
- ◆ **Security:** Provide Security Filter configuration of POE Web Smart Switch. [Explained in section 4.6.](#)
- ◆ **Spanning Tree:** Provide Spanning Tree configuration of POE Web Smart Switch. [Explained in section 4.7](#)
- ◆ **Trunking:** Provide Trunk Setting configuration of POE Web Smart Switch. [Explained in section 4.8.](#)
- ◆ **DHCP Relay Agent:** Provide DHCP Relay Agent configuration of POE Web Smart Switch. [Explained in section 4.9.](#)
- ◆ **Backup/Recovery:** Provide Backup/Recovery configuration of POE Web Smart Switch. [Explained in section 4.10.](#)
- ◆ **Miscellaneous:** Provide Misc Operation configuration of POE Web Smart Switch. [Explained in section 4.11.](#)
- ◆ **SNMP Settings:** Provide SNMP Settings configuration of POE Web Smart Switch. [Explained in section 4.12.](#)
- ◆ **Save Settings:** Provide Save function of POE Web Smart Switch. [Explained in section 4.13.](#)
- ◆ **Logout:** Provide Logout function of POE Web Smart Switch. [Explained in section 4.14.](#)

4.2 Administrator

This section provides System Information, IP Configuration, Password Setting, Factory Default, Firmware Update and Reboot functions of POE Web Smart Ethernet Switch, the screen in [Figure 4-3](#) appears and [Table 4-1](#) describes the System object of POE Web Smart Ethernet Switch.

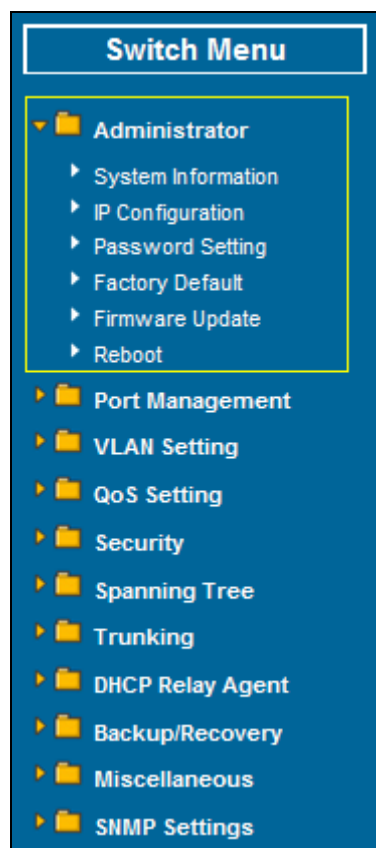

Figure 4-3 System Web Page Screen

Object	Description
System Information	Display the MAC address, and Software Version, Device Description. Explained in section 4.2.1.
IP Configuration	Allow to change the IP subnet address of POE Web Smart Ethernet Switch. Explained in section 4.2.2.
Password Setting	Allow to change the username and password of POE Web Smart Ethernet Switch. Explained in section 4.2.3.
Factory Default	Allow reset the POE Web Smart Ethernet Switch to factory default mode. Explained in section 4.2.4.
Firmware Update	Allow proceed firmware upgrade process of POE Web Smart Ethernet Switch. Explained in section 4.2.5.
Reboot	Allow reboot the POE Web Smart Ethernet Switch. Explained in section 4.2.6.

Table 4-1 Descriptions of the System Web Page Screen Objects

4.2.1 System Information

This section displays the MAC address and Software Version, also allow define the device description and press “Update” button to take affect. The screen in [Figure 4-4](#) appears.

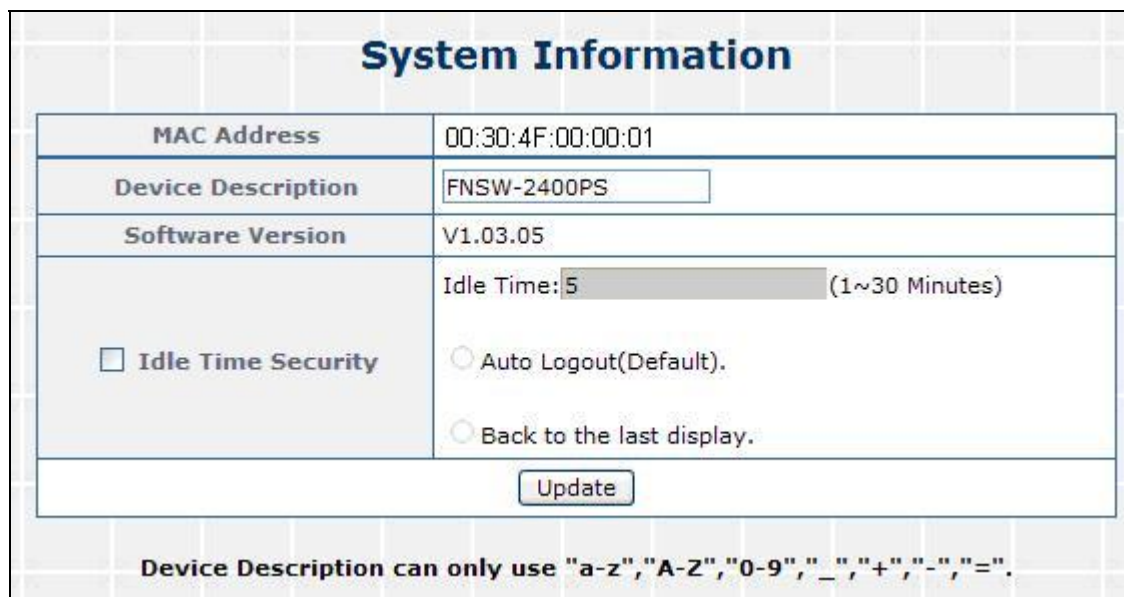

System Information	
MAC Address	00:30:4F:00:00:01
Device Description	<input type="text" value="FNSW-2400PS"/>
Software Version	V1.03.05
<input type="checkbox"/> Idle Time Security	Idle Time: <input type="text" value="5"/> (1~30 Minutes) <input type="radio"/> Auto Logout(Default). <input type="radio"/> Back to the last display.
<input type="button" value="Update"/>	
Device Description can only use "a-z", "A-Z", "0-9", "_", "+", "-", "=".	

Figure 4-4 System Information Web Page Screen

The page includes the following fields:

Object	Description
• MAC Address	Displays the unique hardware address assigned by manufacturer (default).
• Device Description	Describes the Managed Switch. Up to 15 characters is allowed for the Device Description.
• Software Version	The software version of the switch.
• Idle Time Security	Set idle time and behavior.

Table 4-2 Descriptions of the System Information Web Page Screen Objects

4.2.2 IP Configuration

This section provides change the IP Address, Subnet Mask and Gateway, the screen in [Figure 4-5](#) appears.

IP Configuration	
IP Address	192 . 168 . 0 . 101
Subnet Mask	255 . 255 . 255 . 0
Gateway	192 . 168 . 0 . 254
IP Configure	<input checked="" type="radio"/> Static <input type="radio"/> DHCP
<input type="button" value="Update"/>	

Figure 4-5 IP Configuration Web Page Screen

The page includes the following fields:

Object	Description
IP Address	<p>Assign the IP address that the network is using.</p> <p>If DHCP client function is enabled, this switch is configured as a DHCP client. The network DHCP server will assign the IP address to the switch and display it in this column.</p> <p>The default IP is 192.168.0.100 or the user has to assign an IP address manually when DHCP Client is disabled.</p>
Subnet Mask	<p>Assign the subnet mask to the IP address.</p> <p>If DHCP client function is disabled, the user has to assign the subnet mask in this column field.</p> <p>The default subnet mask is 255.255.255.0.</p>
Gateway	<p>Assign the network gateway for the switch.</p> <p>If DHCP client function is disabled, the user has to assign the gateway in this column field.</p> <p>The default gateway is 192.168.0.254.</p>
IP Configure	<p>Select static IP address or DHCP client function</p> <p>When DHCP function is enabled, the POE Web Smart Ethernet Switch will be assigned an IP address from the network DHCP server. The default IP address will be replaced by the assigned IP address on DHCP server. After the user clicks Apply, a popup dialog shows up to inform the user that when the DHCP client is enabled, the current IP will lose and user should find the new IP on the DHCP server.</p>

Table 4-3 Descriptions of the IP Configuration Web Page Screen Objects

4.2.3 Password Setting

This section provides change the Username and Password, the screen in [Figure 4-6](#) appears.

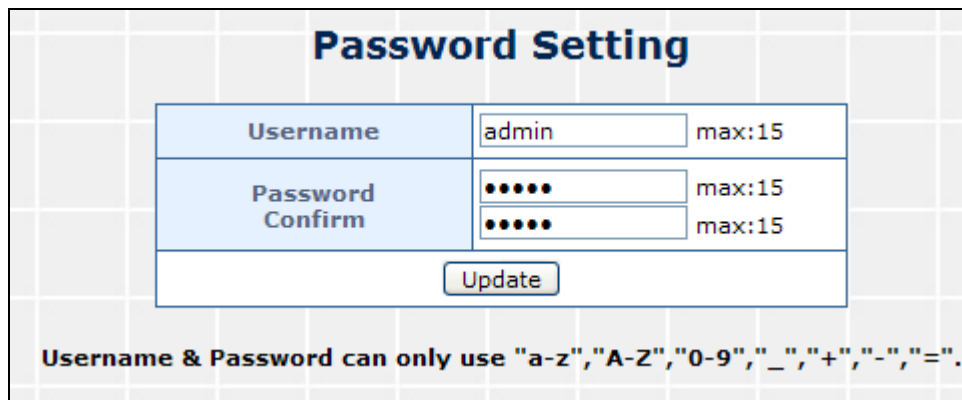

Figure 4-6 Password Setting Web Page Screen

The page includes the following fields:

Object	Description
Username	Displays the user name.
Password Confirm	Specifies the new password. The password is not displayed. As it entered an “•” corresponding to each character is displayed in the field. (The maximum length is 15 characters) Confirms the new password. The password entered into second field must be exactly the same as the password entered in the Password field.

Table 4-4 Descriptions of the Password Setting Web Page Screen Objects

4.2.4 Factory Default

This section provides reset the POE Web Smart Ethernet Switch to factory default mode, the screen in [Figure 4-7](#) appears.

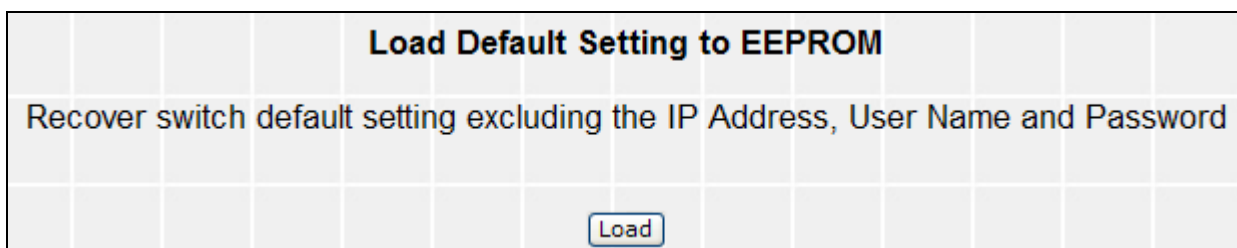

Figure 4-7 Factory Default Web Page Screen

Press “Load” button to take affect. After finish the operation, the following screen in Figure 4-8 appears and please press “Reset” button and it will back to the Web login screen. After input default username and password then can continue the POE Web Smart Ethernet Switch management.

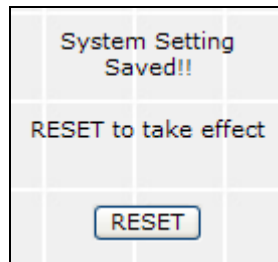

Figure 4-8 Web Page Screen of Factory Default Finish

4.2.5 Firmware Update

This section provides firmware upgrade of the POE Web Smart Ethernet Switch, the screen in Figure 4-9 appears. Before Firmware Update, it will ask for the Password to confirm this procedure.

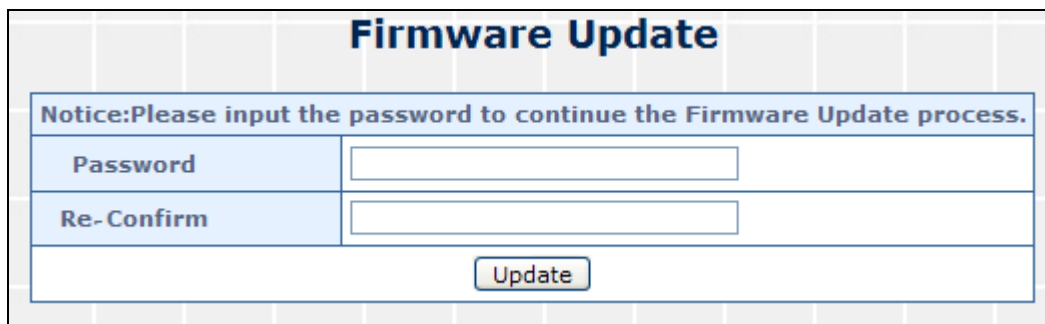

Figure 4-9 Firmware Update Web Page Screen

Key in the password and press “Update” button to take effect, after press the “Update” button, the screen in Figure 4-10 appears. The warning message for double confirming.



Figure 4-10 Warning Message Screen

Press “OK” button for start the firmware upgrade process, the screen in Figure 4-11 appears.

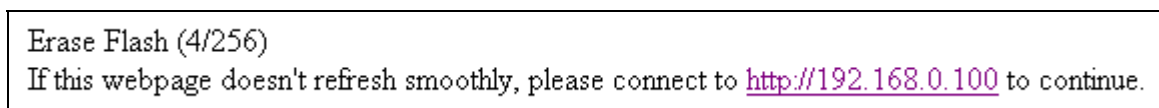

Figure 4-11 Firmware Update Web page Screen

Then the following screen appears, press “**Browser**” button to find the firmware location administrator PC, the screen in Figure 4-12 appears.

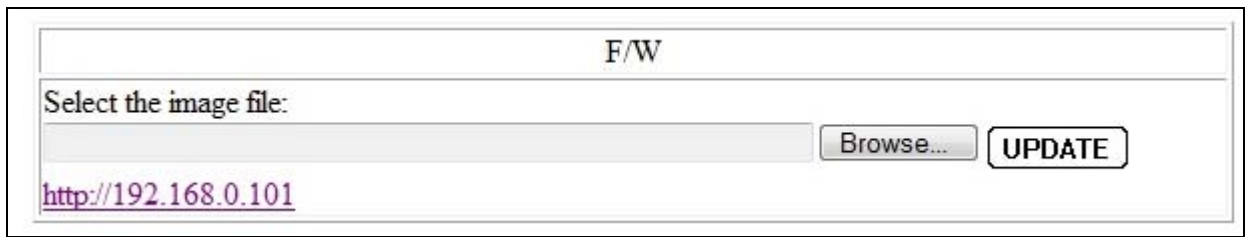

Figure 4-12 Firmware Update Web Page Screen

After find the firmware location from administrator PC, press “**Update**” button to start the firmware upgrade process. The screen in Figure 4-13 appears.



Figure 4-13 Firmware Update Web Page Screen

When firmware upgrade process is completed then the following screen appears, please press the “**continue**” button and wait for system reboot. After device reboot then can use the latest firmware of the POE Web Smart Ethernet Switch.

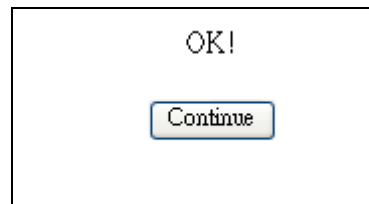

Figure 4-14 Firmware Update Web Page Screen



1. Recommend to use IE 7.0 or FireFox browser tools for firmware upgrade process.
2. Firmware upgrade needs several minutes. Please wait a while, and don't power off the POE Web Smart Ethernet Switch until the update progress is complete.

4.2.6 Reboot

This section allows reboot the POE Web Smart Ethernet Switch, the screen in Figure 4-15 appears.

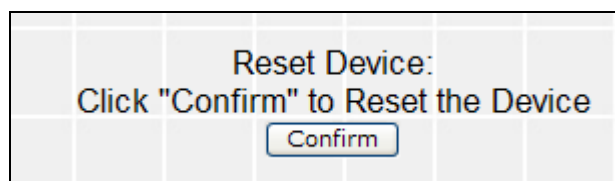

Figure 4-15 Reboot Web Page Screen

Press “**Confirm**” button to reboot the POE Web Smart Ethernet Switch. After device reboot completed, the Web login screen appears and login for further management.

4.3 Port Management

This section provides Port Configuration, Port Mirroring, Bandwidth Control, Broadcast Storm Control and Port Statistics from POE Web Smart Ethernet Switch, the screen in [Figure 4-16](#) appears and [Table 4-5](#) describes the system object of POE Web Smart Ethernet Switch.

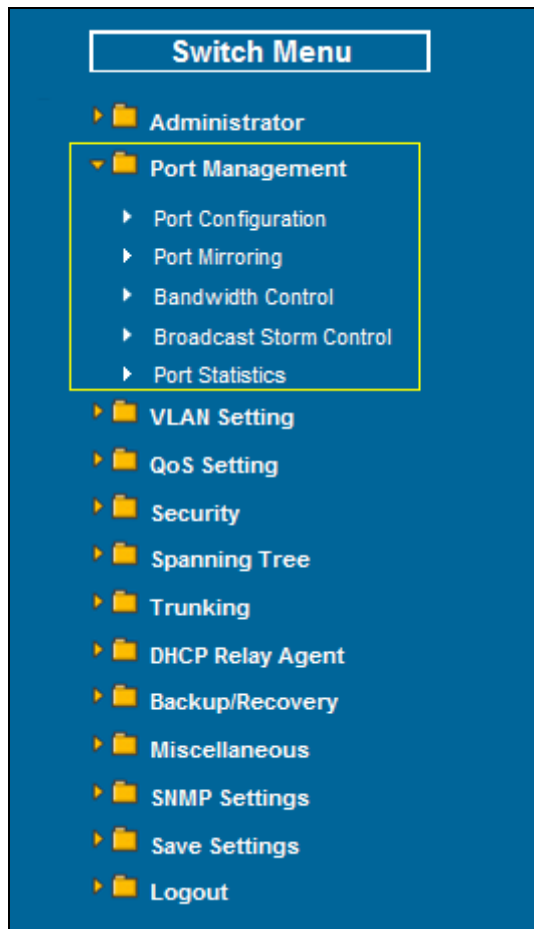

Figure 4-16 Port Management Web Page Screen

Object	Description
Port Configuration	Allow to configure each port of POE Web Smart Ethernet Switch. Explained in section 4.3.1.
Port Mirroring	Allow to use port mirroring function of POE Web Smart Ethernet Switch. Explained in section 4.3.2.
Bandwidth Control	Allow to configure bandwidth control of each port from POE Web Smart Ethernet Switch. Explained in section 4.3.3.
Broadcast Storm Control	Allow to configure broadcast storm control of each port from POE Web Smart Ethernet Switch. Explained in section 4.3.4.
Port Statistics	Display each port statistics of POE Web Smart Ethernet Switch. Explained in section 4.3.5.

Table 4-5 Descriptions of the Port Management Web Page Screen Objects

4.3.1 Port Configuration

This section introduces detail settings of per port on POE Web Smart Ethernet Switch; the screen in [Figure 4-17](#) appears and [Table 4-6](#) descriptions the Port Configuration objects of POE Web Smart Ethernet Switch.

Port Configuration

Function	Enable	Auto-Nego	Speed	Duplex	Symmetric Pause	Asymmetric Pause	Backpressure	Addr. Learning
	----	----	----	----	----	----	----	----
Select Port No.	01 <input type="checkbox"/> 02 <input type="checkbox"/> 03 <input type="checkbox"/> 04 <input type="checkbox"/> 05 <input type="checkbox"/> 06 <input type="checkbox"/> 07 <input type="checkbox"/> 08 <input type="checkbox"/> 09 <input type="checkbox"/> 10 <input type="checkbox"/> 11 <input type="checkbox"/> 12 <input type="checkbox"/> 13 <input type="checkbox"/> 14 <input type="checkbox"/> 15 <input type="checkbox"/> 16 <input type="checkbox"/> 17 <input type="checkbox"/> 18 <input type="checkbox"/> 19 <input type="checkbox"/> 20 <input type="checkbox"/> 21 <input type="checkbox"/> 22 <input type="checkbox"/> 23 <input type="checkbox"/> 24 <input type="checkbox"/>							
<input type="button" value="Update"/>								

Port	Current Status					Setting Status							
	Link	Speed	Duplex	Rx Pause	Tx Pause	Enable	Auto-Nego	Speed	Duplex	Symmetric Pause	Asymmetric Pause	Back pressure	Addr. Learning
1	--	--	--	--	--	Enable	Auto	100M	Full	On	On	On	On
2	--	--	--	--	--	Enable	Auto	100M	Full	On	On	On	On
3	--	--	--	--	--	Enable	Auto	100M	Full	On	On	On	On
4	--	--	--	--	--	Enable	Auto	100M	Full	On	On	On	On
5	--	--	--	--	--	Enable	Auto	100M	Full	On	On	On	On
6	●	100M	Full	On	On	Enable	Auto	100M	Full	On	On	On	On
7	--	--	--	--	--	Enable	Auto	100M	Full	On	On	On	On
8	--	--	--	--	--	Enable	Auto	100M	Full	On	On	On	On
9	--	--	--	--	--	Enable	Auto	100M	Full	On	On	On	On
10	--	--	--	--	--	Enable	Auto	100M	Full	On	On	On	On
11	--	--	--	--	--	Enable	Auto	100M	Full	On	On	On	On
12	--	--	--	--	--	Enable	Auto	100M	Full	On	On	On	On
13	--	--	--	--	--	Enable	Auto	100M	Full	On	On	On	On
14	--	--	--	--	--	Enable	Auto	100M	Full	On	On	On	On
15	--	--	--	--	--	Enable	Auto	100M	Full	On	On	On	On
16	--	--	--	--	--	Enable	Auto	100M	Full	On	On	On	On
17	--	--	--	--	--	Enable	Auto	100M	Full	On	On	On	On
18	--	--	--	--	--	Enable	Auto	100M	Full	On	On	On	On
19	--	--	--	--	--	Enable	Auto	100M	Full	On	On	On	On
20	--	--	--	--	--	Enable	Auto	100M	Full	On	On	On	On
21	--	--	--	--	--	Enable	Auto	100M	Full	On	On	On	On
22	--	--	--	--	--	Enable	Auto	100M	Full	On	On	On	On
23	--	--	--	--	--	Enable	Auto	100M	Full	On	On	On	On
24	--	--	--	--	--	Enable	Auto	100M	Full	On	On	On	On

Figure 4-17 Port Configuration Web Page Screen

The page includes the following fields:

Object	Description
• Enable	Allow choosing all or one port of POE Web Smart Ethernet Switch for further management, the available options is All & 01 to 24 .
• Auto-Nego	Enable and Disable . Being set as Auto, the speed and duplex mode are negotiated automatically. When you set it as Disable , you have to set the speed and duplex mode manually.
• Speed	It is available for selecting when the Negotiation column is set as Force.

	When the Negotiation column is set as Auto, this column is read-only.
• Duplex	It is available for selecting when the Negotiation column is set as Force. When the Negotiation column is set as Auto, this column is read-only.
• Symmetric Pause	Flow Control for Full Duplex. The Device can support Pause Frames flowing in both direction
• Asymmetric Pause	Flow Control for Full Duplex. The Device can only support Pause Frames flowing in one direction
• Back Pressure	Flow Control for Half Duplex. A condition wherein a switch causes a transmitting device to hold off on sending data packets until the switch bottleneck has been eliminated
• Addr. Learning	Address learning is a service that characterizes a learning bridge, in which the source MAC address of each received packet is stored so that future packets destined for that address can be forwarded only to the bridge interface on which that address is located.

Table 4-6 Descriptions of the Port Configuration Web Page Screen Objects

4.3.2 Port Mirroring

This section introduces detail settings of Port Mirroring function of POE Web Smart Ethernet Switch; the screen in [Figure 4-18](#) appears and [Table 4-7](#) descriptions the Port Mirroring objects of POE Web Smart Ethernet Switch.

Port Mirroring												
Destination Port	1	2	3	4	5	6	7	8	9	10	11	12
	13	14	15	16	17	18	19	20	21	22	23	24
Monitored Packets	Disable ▼											
Source Port	1	2	3	4	5	6	7	8	9	10	11	12
	13	14	15	16	17	18	19	20	21	22	23	24
Update												

Figure 4-18 Port Mirroring Web Page Screen

The page includes the following fields:

Object	Description
• Monitored Packets	Provide disable and enable the Port Mirroring function, the available options are Disable , RX , TX , TX & RX . Default mode is Disable .
• Destination Port	The destination port can be used to see all monitor port traffic. It can connect destination port to LAN analyzer or Netxray.
• Source Port	The source port that want to monitor. All monitor port traffic will be copied to destination port.

Table 4-7 Descriptions of the Port Mirroring Screen Objects

4.3.3 Bandwidth Control

This section introduces detail settings of Bandwidth Control function of POE Web Smart Ethernet Switch; the screen in Figure 4-19 appears and Table 4-8 description the Bandwidth Control objects of POE Web Smart Ethernet Switch.

Bandwidth Control

Port No.	Tx Rate	Rx Rate
01 ▼	<input type="text"/> (0~255,0 for full speed)	<input type="text"/> (0~255,0 for full speed)
Speed Base	Low:32Kbps ▼ 1. All ports use the same speed base. 2. When setting the speed base to "High", the rate value must be 0~195. 3. When changing the speed base, the rate values of all ports will be set to 0(full speed).	
<input type="button" value="Update"/>		

Port	Link Speed	Tx Rate(Kbps)	Rx Rate(Kbps)
1	--	Full Speed	Full Speed
2	--	Full Speed	Full Speed
3	--	Full Speed	Full Speed
4	--	Full Speed	Full Speed
5	--	Full Speed	Full Speed
6	100M	Full Speed	Full Speed
7	--	Full Speed	Full Speed
8	--	Full Speed	Full Speed
9	--	Full Speed	Full Speed
10	--	Full Speed	Full Speed
11	--	Full Speed	Full Speed
12	--	Full Speed	Full Speed
13	--	Full Speed	Full Speed
14	--	Full Speed	Full Speed
15	--	Full Speed	Full Speed
16	--	Full Speed	Full Speed

Figure 4-19 Bandwidth Control Web Page Screen

The page includes the following fields:

Object	Description
• Port	Indicate port 1 to port 24
• Tx Rate	Provide 0~255, 0 for Full Speed
• Rx Rate	Provide 0~255, 0 for Full Speed

Table 4-8 Descriptions of the Bandwidth Control Screen Objects

4.3.4 Broadcast Storm Control

This section introduces detail settings of Broadcast Storm Control function of POE Web Smart Ethernet Switch; the screen in Figure 4-20 appears.

Figure 4-20 Broadcast Storm Control Web Page Screen

The broadcast storm control is used to block the excessive broadcast packets, the number ranging from 1 to 63.

For example: The broadcast storm of the port1~6 are enabled and threshold is set to 10. The broadcast packets will be dropped when broadcast packets are more than threshold setting (packet length is 64 bytes).

4.3.5 Port Statistics

This section introduces detail information of Port Statistics function of POE Web Smart Ethernet Switch; the screen in Figure 4-21 appears and Table 4-9 descriptions the Port Statistics objects of POE Web Smart Ethernet Switch.

Port	Receive Packet	Transmit Packet
1	0	0
2	0	0
3	0	0
4	0	0
5	0	0
6	4925	3499
7	0	0

21	0	0
22	0	0
23	0	0
24	0	0

Figure 4-21 Port Statistics Web Page Screen

The page includes the following fields:

Object	Description
<ul style="list-style-type: none"> • Counter Mode Selection 	Provide different type of Ethernet traffic counter mode, the available options are shown as below: Receive Packet & Transmit Packet Transmit Packet & Collision Receive Packet & Packet Drop Receive Packet & CRC error Packet Default mode is Receive Packet & Transmit Packet .
<ul style="list-style-type: none"> • Port 	Indicate port 1 to port 24.
<ul style="list-style-type: none"> • Transmit 	Display Transmit count value from each port.
<ul style="list-style-type: none"> • Receive 	Display Receive count value from each port.

Table 4-9 Descriptions of the Port Statistics Screen Objects

4.4 VLAN Setting

This section provides VLAN Mode, VLAN Member and Multi to 1 Setting from POE Web Smart Ethernet Switch, the screen in [Figure 4-22](#) appears and [Table 4-10](#) describes the system object of POE Web Smart Ethernet Switch.

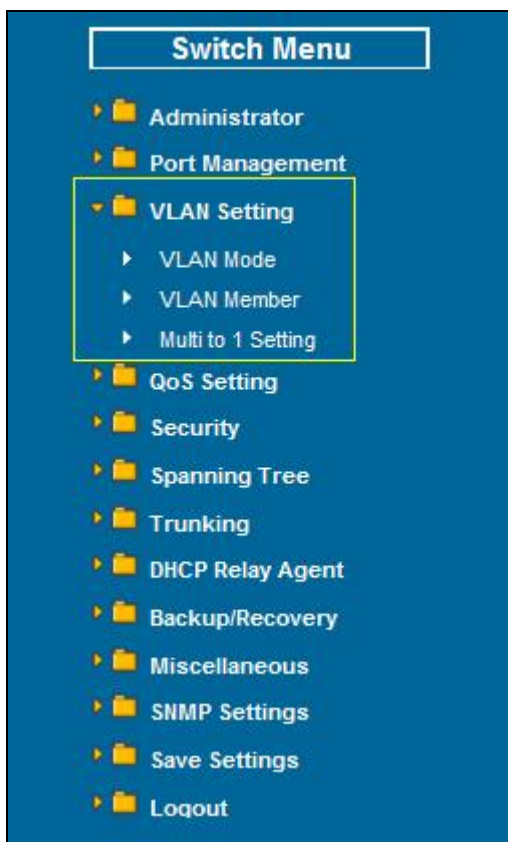

Figure 4-22 VLAN Setting Web Page Screen

Object	Description
VLAN Mode	Allow to select VLAN mode of POE Web Smart Ethernet Switch. Explained in section 4.4.1.
VLAN Member	Allow to Modify the VLAN member port of POE Web Smart Ethernet Switch. Explained in section 4.4.2.
Multi to 1 Setting	Allow to Modify and Enable the function from POE Web Smart Ethernet Switch. Explained in section 4.4.3.

Table 4-10 Descriptions of the VLAN Setting Web Page Screen Objects

A Virtual LAN (VLAN) is a logical network grouping that limits the broadcast domain. It allows you to isolate network traffic so only members of the VLAN receive traffic from the same VLAN members. Basically, creating a VLAN from a switch is logically equivalent of reconnecting a group of network devices to another Layer 2 switch. However, all the network devices are still plug into the same switch physically.

The Switch supports IEEE 802.1Q (tagged-based) and Port-Base VLAN setting in web management page. In the default configuration, VLAN support is “**No VLAN**”.

Port-based VLAN

Port-based VLAN limit traffic that flows into and out of switch ports. Thus, all devices connected to a port are members of the VLAN(s) the port belongs to, whether there is a single computer directly connected to a switch, or an entire department.

On port-based VLAN, NIC do not need to be able to identify 802.1Q tags in packet headers. NIC send and receive normal Ethernet packets. If the packet's destination lies on the same segment, communications take place using normal Ethernet protocols. Even though this is always the case, when the destination for a packet lies on another switch port, VLAN considerations come into play to decide if the packet is dropped by the Switch or delivered.

IEEE 802.1Q Tag Base VLAN

IEEE 802.1Q (tagged) VLAN are implemented on the Switch. 802.1Q VLAN require tagging, which enables them to span the entire network (assuming all switches on the network are IEEE 802.1Q-compliant).

VLAN allow a network to be segmented in order to reduce the size of broadcast domains. All packets entering a VLAN will only be forwarded to the stations (over IEEE 802.1Q enabled switches) that are members of that VLAN, and this includes broadcast, multicast and unicast packets from unknown sources.

VLAN can also provide a level of security to your network. IEEE 802.1Q VLAN will only deliver packets between stations that are members of the VLAN. Any port can be configured as either tagging or untagging. The untagging feature of IEEE 802.1Q VLAN allows VLAN to work with legacy switches that don't recognize VLAN tags in packet headers. The tagging feature allows VLAN to span multiple 802.1Q-compliant switches through a single physical connection and allows Spanning Tree to be enabled on all ports and work normally.

Any port can be configured as either tagging or untagging. The untagging feature of IEEE 802.1Q VLAN allows VLAN to work with legacy switches that don't recognize VLAN tags in packet headers. The tagging feature allows VLAN to span multiple 802.1Q-compliant switches through a single physical connection and allows Spanning Tree to be enabled on all ports and work normally.

Some relevant terms:

Tag - The act of putting 802.1Q VLAN information into the header of a packet.

Untag - The act of stripping 802.1Q VLAN information out of the packet header.

802.1Q VLAN Tags

The figure below shows the 802.1Q VLAN tag. There are four additional octets inserted after the source MAC address. Their presence is indicated by a value of 0x8100 in the Ether Type field. When a packet's Ether Type field is equal to 0x8100, the packet carries the IEEE 802.1Q/802.1p tag. The tag is contained in the following two octets and consists of 3 bits of user priority, 1 bit of Canonical Format Identifier (CFI - used for encapsulating Token Ring packets so they can be carried across Ethernet backbones), and 12 bits of VLAN ID (VID). The 3 bits of user priority are used by 802.1p. The VID is the VLAN identifier and is used by the 802.1Q standard. Because the VID is 12 bits long, 4094 unique VLAN can be identified.

The tag is inserted into the packet header making the entire packet longer by 4 octets. All of the information originally contained in the packet is retained.

802.1Q Tag

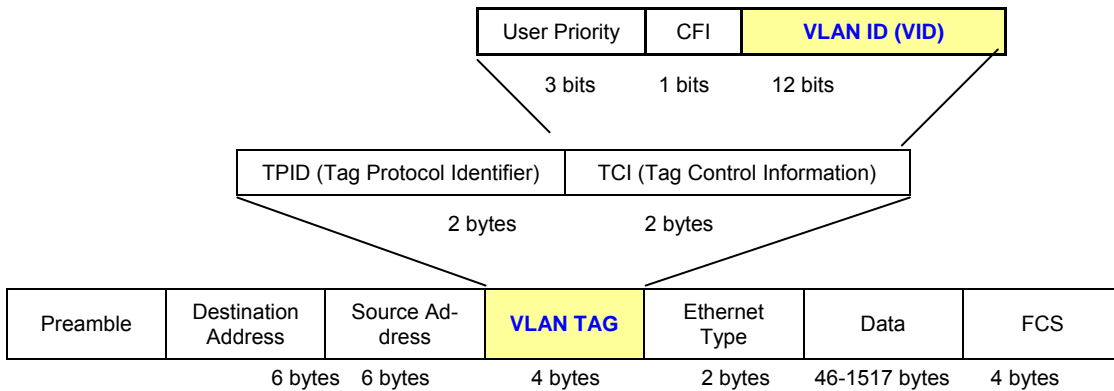

The Ether Type and VLAN ID are inserted after the MAC source address, but before the original Ether Type/Length or Logical Link Control. Because the packet is now a bit longer than it was originally, the Cyclic Redundancy Check (CRC) must be recalculated.

Adding an IEEE802.1Q Tag

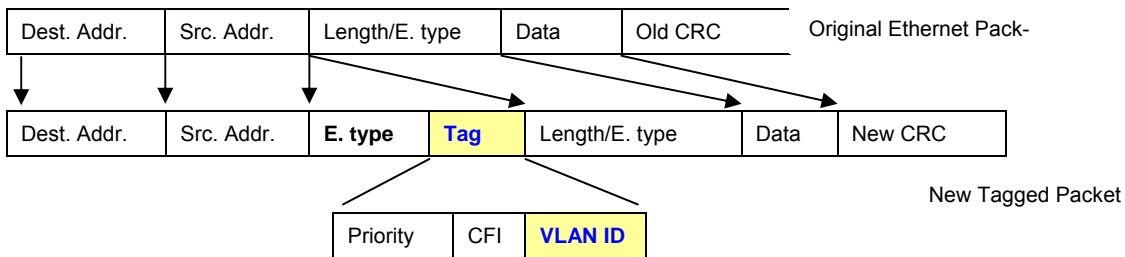

Port VLAN ID

Packets that are tagged (are carrying the 802.1Q VID information) can be transmitted from one 802.1Q compliant network device to another with the VLAN information intact. This allows 802.1Q VLAN to span network devices (and indeed, the entire network – if all network devices are 802.1Q compliant).

Every physical port on a switch has a PVID. 802.1Q ports are also assigned a PVID, for use within the switch. If no VLAN are defined on the switch, all ports are then assigned to a default VLAN with a PVID equal to 1. Untagged packets are assigned the PVID of the port on which they were received. Forwarding decisions are based upon this PVID, in so far as VLAN are concerned. Tagged packets are forwarded according to the VID contained within the tag. Tagged packets are also assigned a PVID, but the PVID is not used to make packet forwarding decisions, the VID is.

Tag-aware switches must keep a table to relate PVID within the switch to VID on the network. The switch will compare the VID of a packet to be transmitted to the VID of the port that is to transmit the packet. If the two VID are different the switch will drop the packet. Because of the existence of the PVID for untagged packets and the VID for tagged packets, tag-aware and tag-unaware network devices can coexist on the same network.

A switch port can have only one PVID, but can have as many VID as the switch has memory in its VLAN table to store them.

Because some devices on a network may be tag-unaware, a decision must be made at each port on a tag-aware device before packets are transmitted – should the packet to be transmitted have a tag or not? If the transmitting port is connected to a tag-unaware device, the packet should be untagged. If the transmitting port is connected to a tag-aware device, the packet should be tagged.

Default VLANs

The Switch initially configures one VLAN, VID = 1, called "**default**." The factory default setting assigns all ports on the Switch to the "**default**". As new VLAN are configured in Port-based mode, their respective member ports are removed from the "default."



Base on the Switch chipset specification, the Switch supports **SVL(Shared VLAN Learning)** , all VLAN groups share the same Layer 2 learned MAC address table.

4.4.1 VLAN Mode

This section provides VLAN Configuration from POE Web Smart Ethernet Switch, the screen in [Figure 4-23](#) appears and [Table 4-11](#) describes the VLAN Configuration object of POE Web Smart Ethernet Switch.

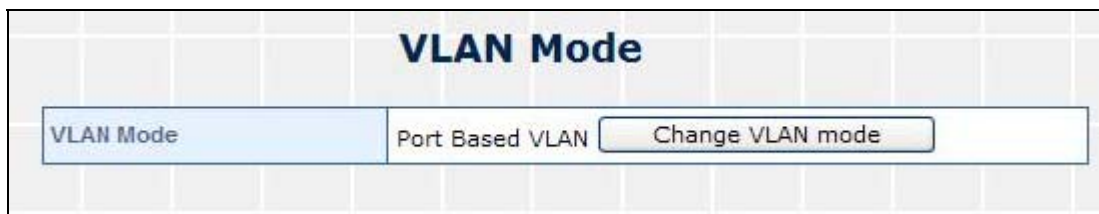

Figure 4-23 VLAN Mode Web Page Screen

The page includes the following fields:

Object	Description
<ul style="list-style-type: none"> VLAN Mode 	Provide different VLAN operation mode, the available options are shown as below: Tag Base VLAN Port Based VLAN Default mode is Port Base VLAN .
<ul style="list-style-type: none"> Change VLAN mode Button 	Changing current VLAN mode of POE Web Smart Ethernet Switch.

Table 4-11 Descriptions of the VLAN Mode Screen Objects

4.4.1.1 Port Base VLAN Mode

The default VLAN mode is “Port Based VLAN” from the VLAN Mode. The screen in Figure 4-24 appears.

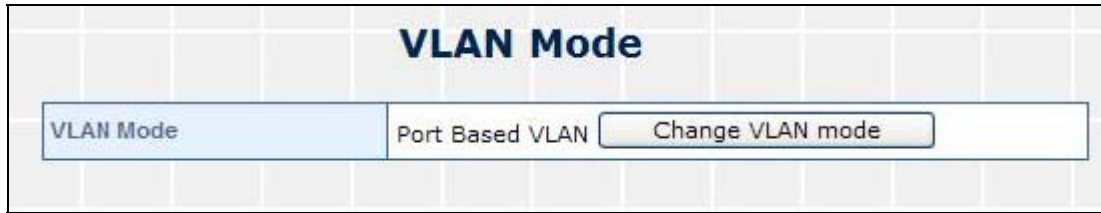

Figure 4-24 Port Base VLAN Mode Web Page Screen

4.4.1.2 Tag Base VLAN Mode

This section introduces detail information of IEEE 802.1Q VLAN function of POE Web Smart Ethernet Switch. To execute “Tag Base VLAN” mode from VLAN Mode, press “Change VLAN mode” button to enable the 802.1Q VLAN function. One screen in Figure 4-25 will appear to ask for confirming to swap VLAN mode.

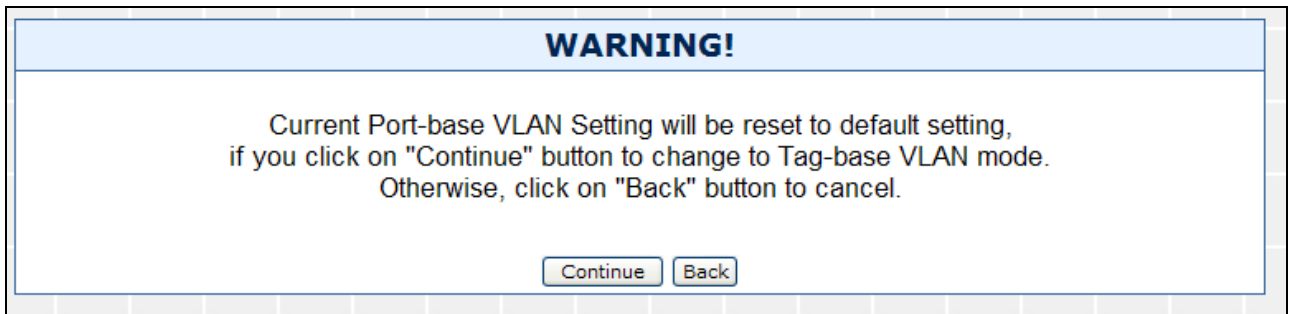

Figure 4-25 Change VLAN Mode Warning Web Page Screen

Press “Continue” button, the current Port-base VLAN mode will swap to the Tag Base VLAN mode. The Screen in Figure 4-26 will appear Table 4-12 description the Tag Base VLAN mode objects of Web Smart Switch press “Update” button to take affect.

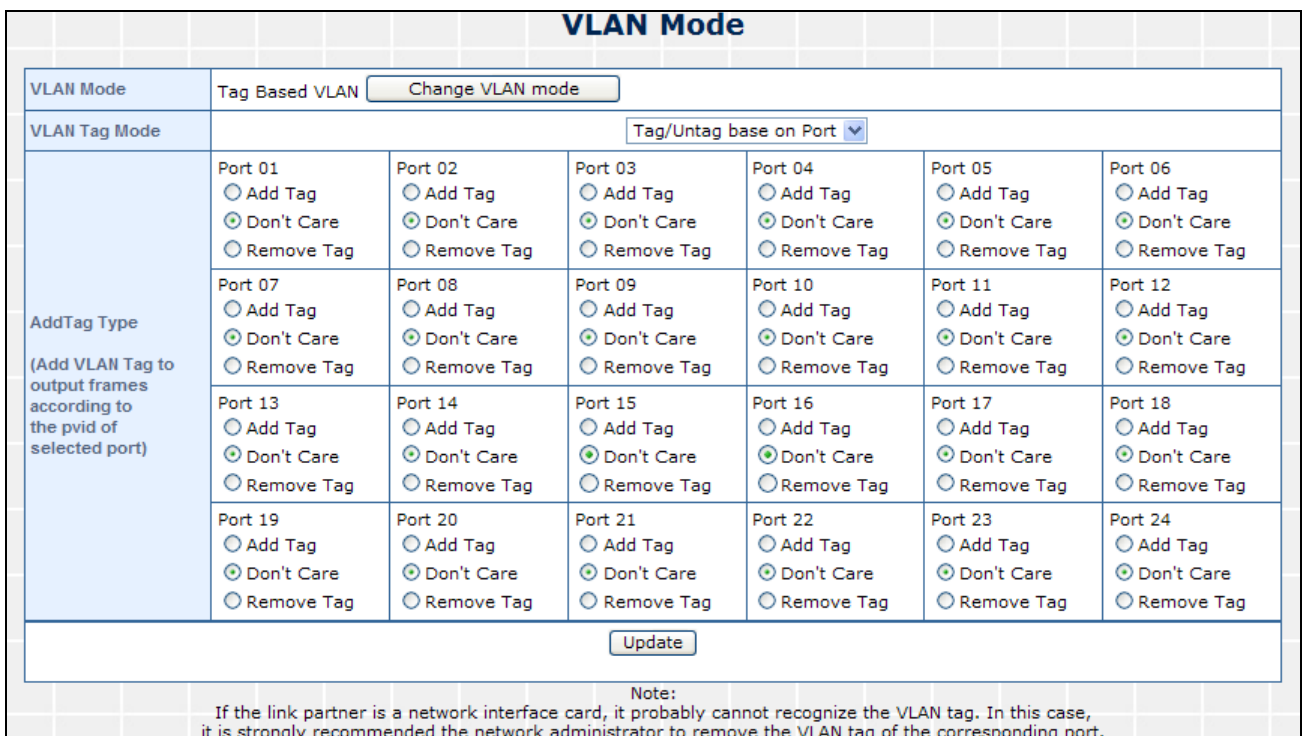

Figure 4-26 802.1Q VLAN Configuration Web Page Screen

The page includes the following fields:

Object	Description
<ul style="list-style-type: none"> VLAN Mode 	Provide different VLAN operation mode, the options are shown as below: Tag Base VLAN Port Based VLAN
<ul style="list-style-type: none"> VLAN Tag Mode 	Include Two mode: Tag / Untag base on Port Tag / Untag base on Port
<ul style="list-style-type: none"> Add Tag Type 	Customize Tag or Untage for per port

Table 4-12 Descriptions of the Tag Base VLAN Setting Screen Objects

4.4.2 VLAN Member

This section introduces detail information of VLAN Member function of POE Web Smart Ethernet Switch. It has two kind of VLAN Member types, one is for Port Base VLAN mode and one is for Tag Base VLAN mode which depend on your . The Screen Figure 4-27 & 4-28 show the type of VLAN Member and the Table 4-13 & 4-14 description the type of VLAN Member objects of Web Smart Switch.

VLAN Member Setting (Port Based)

Name (max 10 characters)

Destination PORT	01	02	03	04	05	06	07	08
Select	<input checked="" type="checkbox"/>	<input checked="" type="checkbox"/>	<input checked="" type="checkbox"/>	<input checked="" type="checkbox"/>	<input checked="" type="checkbox"/>	<input checked="" type="checkbox"/>	<input checked="" type="checkbox"/>	<input checked="" type="checkbox"/>
Destination PORT	09	10	11	12	13	14	15	16
Select	<input checked="" type="checkbox"/>	<input checked="" type="checkbox"/>	<input checked="" type="checkbox"/>	<input checked="" type="checkbox"/>	<input checked="" type="checkbox"/>	<input checked="" type="checkbox"/>	<input checked="" type="checkbox"/>	<input checked="" type="checkbox"/>
Destination PORT	17	18	19	20	21	22	23	24
Select	<input checked="" type="checkbox"/>	<input checked="" type="checkbox"/>	<input checked="" type="checkbox"/>	<input checked="" type="checkbox"/>	<input checked="" type="checkbox"/>	<input checked="" type="checkbox"/>	<input checked="" type="checkbox"/>	<input checked="" type="checkbox"/>

VLAN MEMBER																								
Port Num	01	02	03	04	05	06	07	08	09	10	11	12	13	14	15	16	17	18	19	20	21	22	23	24
	-	-	-	-	-	-	-	-	-	-	-	-	-	-	-	-	-	-	-	-	-	-	-	-

Figure 4-27 VLAN Member Setting (Port Based) Web Page Screen

The page includes the following fields:

Object	Description
<ul style="list-style-type: none"> Name 	Assign and display different VLAN name from multi-port based VLAN groups. Up to maximum 10 characters allow.
<ul style="list-style-type: none"> Add Button 	Press this button for add a new port based VLAN groups. Up to maximum 24 port based VLAN groups .

• Rename Button	Allow to change the Name
• Delete Button	Allow to delete the group which has been created
• Update Button	Allow to update the group when change/modify the port members
• Load Default Button	Back to VLAN member default, all of groups will be clear

Table 4-13 Descriptions of the VLAN Member Setting (Port Based) Screen Objects

VLAN Member Setting (Tag Based)

▼

Add: Enter a VID, select the VLAN member for this entry and then press this button to add a VLAN entry to the table.
 Del: Select a VID in the table and then press this button to remove a VID entry from the table.
 Update: Modify the existing VID entry, select VID and then press the button.

VLAN Setting	01	02	03	04	05	06	07	08
member select	<input checked="" type="checkbox"/>	<input checked="" type="checkbox"/>	<input checked="" type="checkbox"/>	<input checked="" type="checkbox"/>	<input checked="" type="checkbox"/>	<input checked="" type="checkbox"/>	<input checked="" type="checkbox"/>	<input checked="" type="checkbox"/>
PVID select	<input type="checkbox"/>	<input type="checkbox"/>	<input type="checkbox"/>	<input type="checkbox"/>	<input type="checkbox"/>	<input type="checkbox"/>	<input type="checkbox"/>	<input type="checkbox"/>
VLAN Setting	09	10	11	12	13	14	15	16
member select	<input checked="" type="checkbox"/>	<input checked="" type="checkbox"/>	<input checked="" type="checkbox"/>	<input checked="" type="checkbox"/>	<input checked="" type="checkbox"/>	<input checked="" type="checkbox"/>	<input checked="" type="checkbox"/>	<input checked="" type="checkbox"/>
PVID select	<input type="checkbox"/>	<input type="checkbox"/>	<input type="checkbox"/>	<input type="checkbox"/>	<input type="checkbox"/>	<input type="checkbox"/>	<input type="checkbox"/>	<input type="checkbox"/>
VLAN Setting	17	18	19	20	21	22	23	24
member select	<input checked="" type="checkbox"/>	<input checked="" type="checkbox"/>	<input checked="" type="checkbox"/>	<input checked="" type="checkbox"/>	<input checked="" type="checkbox"/>	<input checked="" type="checkbox"/>	<input checked="" type="checkbox"/>	<input checked="" type="checkbox"/>
PVID select	<input type="checkbox"/>	<input type="checkbox"/>	<input type="checkbox"/>	<input type="checkbox"/>	<input type="checkbox"/>	<input type="checkbox"/>	<input type="checkbox"/>	<input type="checkbox"/>

Port VID Map								
Port	01	02	03	04	05	06	07	08
VID	1	1	1	1	1	1	1	1
Port	09	10	11	12	13	14	15	16
VID	1	1	1	1	1	1	1	1
Port	17	18	19	20	21	22	23	24
VID	1	1	1	1	1	1	1	1

VLAN MEMBER																								
Name(VID)	01	02	03	04	05	06	07	08	09	10	11	12	13	14	15	16	17	18	19	20	21	22	23	24
CPU_CTRL(1)	v	v	v	v	v	v	v	v	v	v	v	v	v	v	v	v	v	v	v	v	v	v	v	v

Figure 4-28 VLAN Member Setting (Tag Based) Web Page Screen

The page includes the following fields:

Object	Description
• VID (1~4094)	Display different VLAN ID from multi-Tag Base VLAN mode groups.
• Name	Assign and display different VLAN name from multi-Tag Base VLAN VLAN groups. Up to maximum 10 characters allow.
• Add Button	Press this button for add a new port based VLAN groups. Up to maximum 24 port based VLAN groups .
• Delete Button	Allow to delete the group which has been created
• Update Button	Allow to update the group when change/modify the port members

Table 4-14 Descriptions of the VLAN Member Setting (Tag Based) Screen Objects

4.4.3 Multi to 1 Setting

This setting is exclusive to VLAN setting on "VLAN member setting ". When VLAN member setting is updated, multi-to-1 setting will be void and vice versa. The "disable port" means the port is excluded in this setting. All ports excluded in this setting are treated as the same VLAN group. The Screen [Figure 4-29](#) shows the Multi to 1 Setting.

Multi to 1 Setting

Enable	Disable <input type="button" value="v"/>																								
Destination PortNo	Port : 01 <input type="button" value="v"/>																								
Current Setting	Port:-																								
Disable Port	<table style="width: 100%; text-align: center;"> <tr> <td><input type="checkbox"/> 01</td><td><input type="checkbox"/> 02</td><td><input type="checkbox"/> 03</td><td><input type="checkbox"/> 04</td><td><input type="checkbox"/> 05</td><td><input type="checkbox"/> 06</td><td><input type="checkbox"/> 07</td><td><input type="checkbox"/> 08</td><td><input type="checkbox"/> 09</td><td><input type="checkbox"/> 10</td><td><input type="checkbox"/> 11</td><td><input type="checkbox"/> 12</td><td><input type="checkbox"/> 13</td><td><input type="checkbox"/> 14</td><td><input type="checkbox"/> 15</td><td><input type="checkbox"/> 16</td><td><input type="checkbox"/> 17</td><td><input type="checkbox"/> 18</td><td><input type="checkbox"/> 19</td><td><input type="checkbox"/> 20</td><td><input type="checkbox"/> 21</td><td><input type="checkbox"/> 22</td><td><input type="checkbox"/> 23</td><td><input type="checkbox"/> 24</td> </tr> </table>	<input type="checkbox"/> 01	<input type="checkbox"/> 02	<input type="checkbox"/> 03	<input type="checkbox"/> 04	<input type="checkbox"/> 05	<input type="checkbox"/> 06	<input type="checkbox"/> 07	<input type="checkbox"/> 08	<input type="checkbox"/> 09	<input type="checkbox"/> 10	<input type="checkbox"/> 11	<input type="checkbox"/> 12	<input type="checkbox"/> 13	<input type="checkbox"/> 14	<input type="checkbox"/> 15	<input type="checkbox"/> 16	<input type="checkbox"/> 17	<input type="checkbox"/> 18	<input type="checkbox"/> 19	<input type="checkbox"/> 20	<input type="checkbox"/> 21	<input type="checkbox"/> 22	<input type="checkbox"/> 23	<input type="checkbox"/> 24
	<input type="checkbox"/> 01	<input type="checkbox"/> 02	<input type="checkbox"/> 03	<input type="checkbox"/> 04	<input type="checkbox"/> 05	<input type="checkbox"/> 06	<input type="checkbox"/> 07	<input type="checkbox"/> 08	<input type="checkbox"/> 09	<input type="checkbox"/> 10	<input type="checkbox"/> 11	<input type="checkbox"/> 12	<input type="checkbox"/> 13	<input type="checkbox"/> 14	<input type="checkbox"/> 15	<input type="checkbox"/> 16	<input type="checkbox"/> 17	<input type="checkbox"/> 18	<input type="checkbox"/> 19	<input type="checkbox"/> 20	<input type="checkbox"/> 21	<input type="checkbox"/> 22	<input type="checkbox"/> 23	<input type="checkbox"/> 24	
<input type="button" value="Update"/>																									

1.A example for Multi-to-1 structure

**Destination Port/
Current Setting**

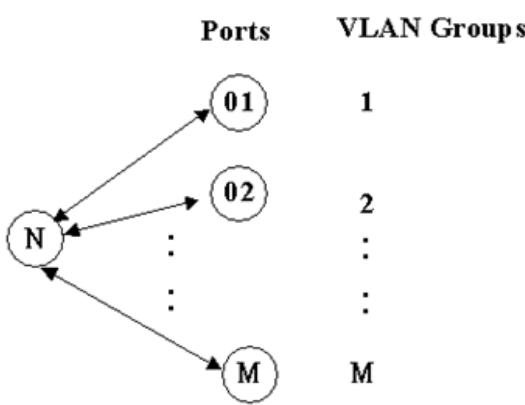

Ports

VLAN Groups

2.The original setting of the VLAN Group will be cleared and replaced by this special structure if you enable this function. On the other hand, If you set the VLAN Group again, this special structure will be cleared and replaced by your newest setting.

Figure 4-29 Multi to 1 Setting Web Page Screen

4.5 QoS Setting

This function provides QoS Setting of Web Smart Switch; the screen in [Figure 4-30](#) appears and [Table 4-15](#) descriptions the QoS Setting of Web Smart Switch.

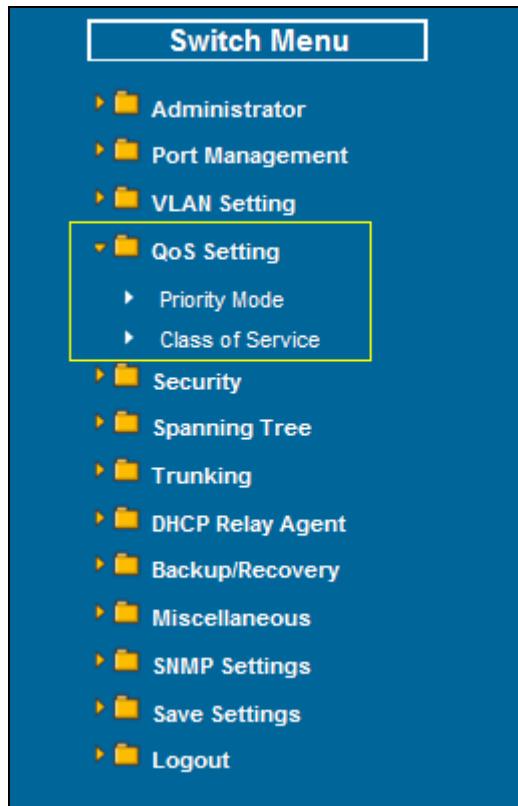

Figure 4-30 QoS Setting Web Page Screen

The page includes the following fields:

Object	Description
<ul style="list-style-type: none"> • Priority Mode 	Provide three different Priority polices on Web Smart Switch. Explained in section 4.5.1.
<ul style="list-style-type: none"> • Class of Service Configuration 	Provide four different polices on each port of Web Smart Switch. Explained in section 4.5.2.

Table 4-15 Descriptions of the QoS Setting Screen Objects

4.5.1 Priority Mode

This section introduces detail information of Priority Mode of Web Smart Switch; the screen in [Figure 4-31](#) appears and [Table 4-16](#) descriptions the Priority Mode of Web Smart Switch.

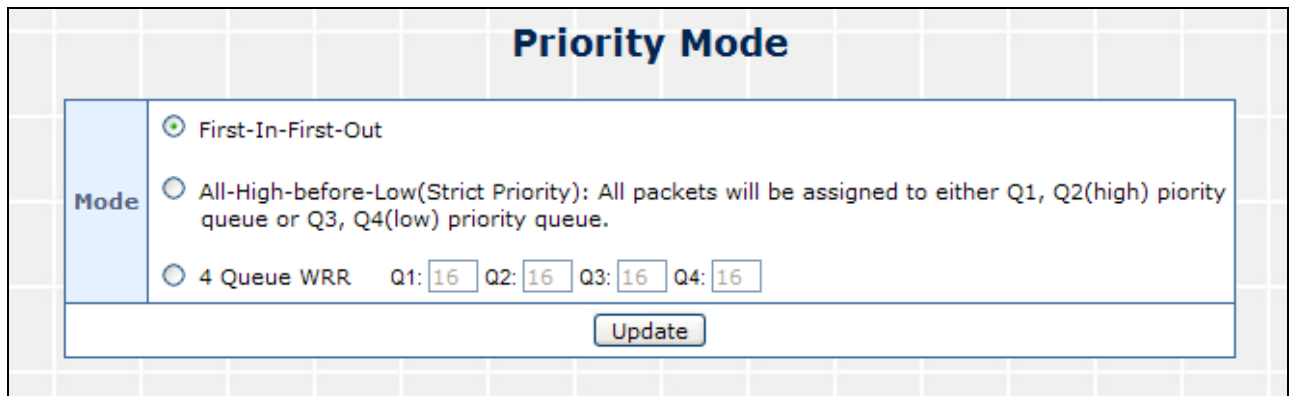

Figure 4-31 Priority Mode Web Page Screen

The page includes the following fields:

Object	Description
<ul style="list-style-type: none"> • Priority Mode 	<p>Provide three different Priority polices on Web Smart Switch, the available options are shown as below:</p> <p>Fist-In-First-Out</p> <p>All-High-Before-Low</p> <p>4 Queue WRR = Q3 and Q4 Low weight (0-16 range) : Q1 and Q2 High weight (0-16 range)</p> <p>Default mode is First-In-First-Out.</p>

Table 4-16 Descriptions of the Priority Mode Screen Objects

4.5.2 Class of Service

This section introduces detail information of Class of Service Configuration of Web Smart Switch; the Class of Service has four types of services, TCP / UDP port, IP TOS / DS, 802.1p and physical port. The switch treats TCP / UDP port, IP TOS / DS, 802.1p and physical port CoS scheme in the following priority. TCP / UDP > IP TOS / DS > 802.1p > physical port. This means TCP / UDP CoS will override all other settings. The screen in [Figure 4-32](#) appears.

Class of Service

The switch treats TCP/UDP, IP TOS/DS, 802.1p and physical port CoS scheme in the following priority.
 TCP/UDP > IP TOS/DS > 802.1p > Physical port.
 This means TCP/UDP CoS will override all other settings.

(1) TCP/UDP port

Protocol	Note: (1) Q1 ~ Q4 options are effective for the selected physical port only. (2) "Drop" option is the global setting for all physical ports.				
FTP	Q4 <input type="button" value="v"/>	SSH	Q4 <input type="button" value="v"/>	TELNET	Q4 <input type="button" value="v"/>
SMTP	Q4 <input type="button" value="v"/>	DNS	Q4 <input type="button" value="v"/>	TFTP	Q4 <input type="button" value="v"/>
HTTP	Q4 <input type="button" value="v"/>	POP3	Q4 <input type="button" value="v"/>	NEWS	Q4 <input type="button" value="v"/>
SNTP	Q4 <input type="button" value="v"/>	NetBIOS	Q4 <input type="button" value="v"/>	IMAP	Q4 <input type="button" value="v"/>
SNMP	Q4 <input type="button" value="v"/>	HTTPS	Q4 <input type="button" value="v"/>	MSN	Q4 <input type="button" value="v"/>
XRD_RDP	Q4 <input type="button" value="v"/>	QQ	Q4 <input type="button" value="v"/>	ICQ	Q4 <input type="button" value="v"/>
Yahoo	Q4 <input type="button" value="v"/>	BOOTP/DHCP	Q1 <input type="button" value="v"/>	User-defined A TCP/UDP	Q4 <input type="button" value="v"/>
User-defined B TCP/UDP	Q4 <input type="button" value="v"/>	User-defined C TCP/UDP	Q4 <input type="button" value="v"/>		
Note: These user-defined TCP/UDP port are the same as that used in TCP/UDP filter					
User-defined A Port: <input type="text"/> ~ Port: <input type="text"/>		User-defined B Port: <input type="text"/> ~ Port: <input type="text"/>		User-defined C Port: <input type="text"/> ~ Port: <input type="text"/>	

The TCP/UDP port will be checked on the following physical port							
01	02	03	04	05	06	07	08
<input type="checkbox"/>	<input type="checkbox"/>	<input type="checkbox"/>	<input type="checkbox"/>	<input type="checkbox"/>	<input type="checkbox"/>	<input type="checkbox"/>	<input type="checkbox"/>
09	10	11	12	13	14	15	16
<input type="checkbox"/>	<input type="checkbox"/>	<input type="checkbox"/>	<input type="checkbox"/>	<input type="checkbox"/>	<input type="checkbox"/>	<input type="checkbox"/>	<input type="checkbox"/>
17	18	19	20	21	22	23	24
<input type="checkbox"/>	<input type="checkbox"/>	<input type="checkbox"/>	<input type="checkbox"/>	<input type="checkbox"/>	<input type="checkbox"/>	<input type="checkbox"/>	<input type="checkbox"/>
<input type="button" value="Update"/>							

The Class of Service for TCP/UDP port number allows the network administrator to assign the specific application to a priority queue.

(2) IP TOS/DS

IP TOS/DS Priority Setting	6'b001010: Q2 <input type="button" value="v"/>	6'b010010: Q1 <input type="button" value="v"/>	6'b011010: Q1 <input type="button" value="v"/>	6'b100010: Q1 <input type="button" value="v"/>			
	6'b101110: Q1 <input type="button" value="v"/>	6'b110000: Q1 <input type="button" value="v"/>	6'b111000: Q1 <input type="button" value="v"/>	Other Values: Q4			
IP TOS/DS Port Setting							
01	02	03	04	05	06	07	08
<input type="checkbox"/>	<input type="checkbox"/>	<input type="checkbox"/>	<input type="checkbox"/>	<input type="checkbox"/>	<input type="checkbox"/>	<input type="checkbox"/>	<input type="checkbox"/>
09	10	11	12	13	14	15	16
<input type="checkbox"/>	<input type="checkbox"/>	<input type="checkbox"/>	<input type="checkbox"/>	<input type="checkbox"/>	<input type="checkbox"/>	<input type="checkbox"/>	<input type="checkbox"/>
17	18	19	20	21	22	23	24
<input type="checkbox"/>	<input type="checkbox"/>	<input type="checkbox"/>	<input type="checkbox"/>	<input type="checkbox"/>	<input type="checkbox"/>	<input type="checkbox"/>	<input type="checkbox"/>
<input type="button" value="Update"/>							

(3) 802.1p

For 802.1p priority field, the switch utilizes the following priority mapping table.
 6 and 7 are mapped to the "Q1" priority queue.
 4 and 5 are mapped to the "Q2" priority queue.
 2 and 3 are mapped to the "Q3" priority queue.
 0 and 1 are mapped to the "Q4" priority queue.

Select Port							
01 <input type="checkbox"/>	02 <input type="checkbox"/>	03 <input type="checkbox"/>	04 <input type="checkbox"/>	05 <input type="checkbox"/>	06 <input type="checkbox"/>	07 <input type="checkbox"/>	08 <input type="checkbox"/>
09 <input type="checkbox"/>	10 <input type="checkbox"/>	11 <input type="checkbox"/>	12 <input type="checkbox"/>	13 <input type="checkbox"/>	14 <input type="checkbox"/>	15 <input type="checkbox"/>	16 <input type="checkbox"/>
17 <input type="checkbox"/>	18 <input type="checkbox"/>	19 <input type="checkbox"/>	20 <input type="checkbox"/>	21 <input type="checkbox"/>	22 <input type="checkbox"/>	23 <input type="checkbox"/>	24 <input type="checkbox"/>

(4) Physical port

1	2	3	4	5	6	7	8
Q1 ▾	Q4 ▾	Q4 ▾	Q4 ▾	Q4 ▾	Q4 ▾	Q4 ▾	Q4 ▾
9	10	11	12	13	14	15	16
Q4 ▾	Q4 ▾	Q4 ▾	Q4 ▾	Q4 ▾	Q4 ▾	Q4 ▾	Q4 ▾
17	18	19	20	21	22	23	24
Q4 ▾	Q4 ▾	Q4 ▾	Q4 ▾	Q4 ▾	Q4 ▾	Q4 ▾	Q4 ▾

Figure 4-32 Class of Service Web Page Screen

4.6 Security

This function provides Security of POE Web Smart Ethernet Switch; the screen in [Figure 4-33](#) appears and [Table 4-17](#) descriptions the Security of POE Web Smart Ethernet Switch.

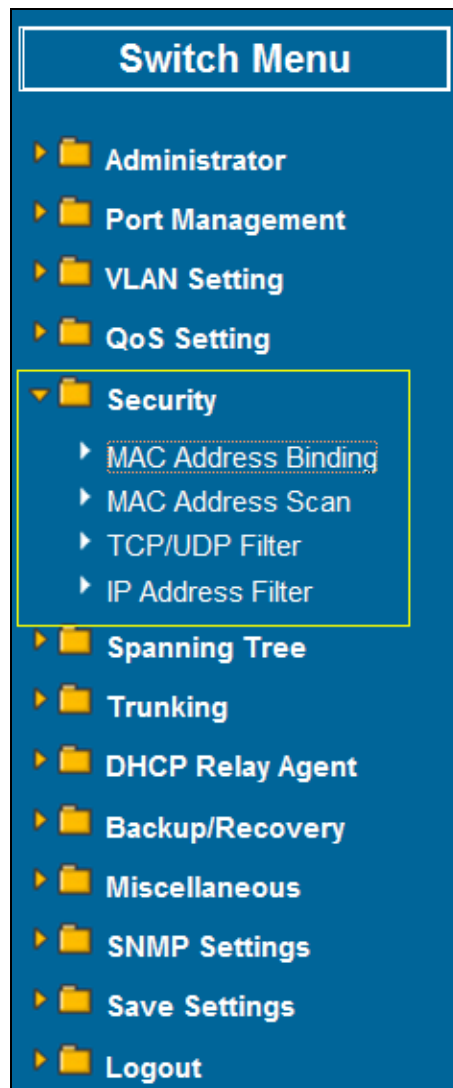

Figure 4-33 Security Filter Web Page Screen

The page includes the following fields:

Object	Description
<ul style="list-style-type: none"> • MAC Address Binding 	Allow to define three MAC Address on per port of POE Web Smart Ethernet Switch. Explained in section 4.7.1.
<ul style="list-style-type: none"> • MAC Address Scan 	Allow to detect the MAC on per port of POE Web Smart Ethernet Switch. Explained in section 4.7.2.
<ul style="list-style-type: none"> • TCP/UDP Filter 	Allow to define the filter policy of TCP / UDP flow on POE Web Smart Ethernet Switch. Explained in section 4.7.3.
<ul style="list-style-type: none"> • IP Address Filter 	Allow to define the filter policy of IP flow on POE Web Smart Ethernet Switch. Explained in section 4.7.4.

Table 4-17 Descriptions of the Security Filter Web Page Screen Objects

4.6.1 MAC Address Binding

This section introduces detail information of MAC Address Binding of POE Web Smart Ethernet Switch; the screen in [Figure 4-34](#) appears and [Table 4-18](#) descriptions the MAC Address Binding of POE Web Smart Ethernet Switch.

Port No	MAC Address
1	<input type="text"/> : <input type="text"/> : <input type="text"/> : <input type="text"/> : <input type="text"/> : <input type="text"/> <input type="text"/> : <input type="text"/> : <input type="text"/> : <input type="text"/> : <input type="text"/> : <input type="text"/> <input type="text"/> : <input type="text"/> : <input type="text"/> : <input type="text"/> : <input type="text"/> : <input type="text"/>

Select Port Binding

Port No	Filter Status	Port No	Filter Status
1	Disable	13	Disable
2	Disable	14	Disable
3	Disable	15	Disable
4	Disable	16	Disable
5	Disable	17	Disable
6	Disable	18	Disable
7	Disable	19	Disable
8	Disable	20	Disable
9	Disable	21	Disable
10	Disable	22	Disable
11	Disable	23	Disable
12	Disable	24	Disable

Figure 4-34 MAC Address Binding Web Page Screen

The page includes the following fields:

Object	Description
<ul style="list-style-type: none"> • MAC Address 	Allow to input three MAC Address on per port of POE Web Smart Ethernet Switch.
<ul style="list-style-type: none"> • Select Port 	Allow to select port 1 to port 24.

• Binding	Allow to Disable or Enable the binding function on each port of POE Web Smart Ethernet Switch.
• Port	Indicate port 1 to port 24.
• Binding Status	Display Binding Status from each port of POE Web Smart Ethernet Switch.

Table 4-18 Descriptions of the MAC Address Binding Screen Objects

4.6.2 TCP / UDP Scan

This section is help to detect the MAC on per port of POE Web Smart Ethernet Switch; the screen in [Figure 4-35](#) appears and [Table 4-19](#) descriptions the MAC Address Scan of POE Web Smart Ethernet Switch.

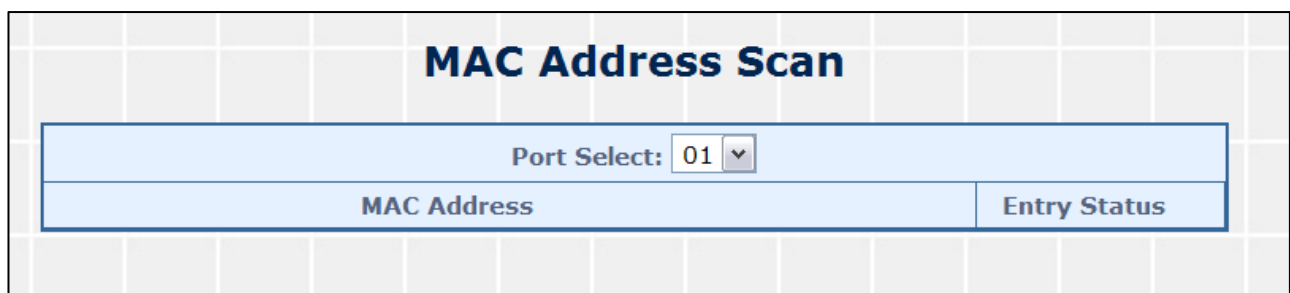

Figure 4-35 MAC Address Binding Web Page Screen

Object	Description
• Port Select	Allow to select port 1 to port 24.
• MAC Address	Display the MAC address on per port.
• Entry Status	Display the MAC Status from each port of POE Web Smart Ethernet Switch.

Table 4-19 Descriptions of the MAC Address Scan Screen Objects

4.6.3 TCP / UDP Filter

This section introduces detail information of TCP / UDP Filter of POE Web Smart Ethernet Switch; the screen in [Figure 4-36](#) appears and [Table 4-20](#) descriptions the TCP / UDP Filter Configuration of POE Web Smart Ethernet Switch.

TCP/UDP Filter				
Function Enable	Disable ▾			
Port Filtering Rule	Deny ▾ "Deny" means the outgoing packets to the selected port with selected protocol will be dropped and other protocols will be forwarded. "Allow" means the selected protocol will be forwarded and other protocol will be dropped. Note: 1. The secure WAN port should be set at the physical port which is connected to the server. 2. Once this function is enabled, the switch will check the destination TCP/UDP port number at the outgoing direction of the secure WAN port. If the condition matches, this packet will be dropped or forwarded.			
Secure Port	<input type="checkbox"/> Port01	<input type="checkbox"/> Port02	<input type="checkbox"/> Port03	<input type="checkbox"/> Port04
	<input type="checkbox"/> Port05	<input type="checkbox"/> Port06	<input type="checkbox"/> Port07	<input type="checkbox"/> Port08
	<input type="checkbox"/> Port09	<input type="checkbox"/> Port10	<input type="checkbox"/> Port11	<input type="checkbox"/> Port12
	<input type="checkbox"/> Port13	<input type="checkbox"/> Port14	<input type="checkbox"/> Port15	<input type="checkbox"/> Port16
	<input type="checkbox"/> Port17	<input type="checkbox"/> Port18	<input type="checkbox"/> Port19	<input type="checkbox"/> Port20
	<input type="checkbox"/> Port21	<input type="checkbox"/> Port22	<input type="checkbox"/> Port23	<input type="checkbox"/> Port24
Protocol	<input type="checkbox"/> FTP	<input type="checkbox"/> SSH	<input type="checkbox"/> TELNET	<input type="checkbox"/> SMTP
	<input type="checkbox"/> DNS	<input type="checkbox"/> TFTP	<input type="checkbox"/> HTTP	<input type="checkbox"/> POP3
	<input type="checkbox"/> NEWS	<input type="checkbox"/> SNTP	<input type="checkbox"/> NetBIOS	<input type="checkbox"/> IMAP
	<input type="checkbox"/> SNMP	<input type="checkbox"/> HTTPS	<input type="checkbox"/> MSN	<input type="checkbox"/> XRD_RDP
	<input type="checkbox"/> QQ	<input type="checkbox"/> ICQ	<input type="checkbox"/> Yahoo	<input type="checkbox"/> BOOTP/ DHCP
	<input type="checkbox"/> User-defined A TCP/UDP	<input type="checkbox"/> User-defined B TCP/UDP	<input type="checkbox"/> User-defined C TCP/UDP	
<input type="button" value="Update"/> <input type="button" value="Clear"/>				

Figure 4-36 TCP / UDP Filter Web Page Screen

The page includes the following fields:

Object	Description
• Function Enable	Allow to Disable or Enable the TCP / UDP Filter function. Default mode is Disable .
• Port Filtering Rule	Allow to Forward or Block the Port Filtering Rule. Default mode is Block .
• Secure Port	Indicate port 1 to port 24. Click specific port for filtering.
• FTP(20,21)	Allow to choose list protocol for filtering
• SSH(22)	
• TELNET(23)	
• SMTP(25)	
• DNS(53)	
• TFTP(69)	
• HTTP(80,8080)	
• POP3(110)	
• NEWS(119)	
• SNTP(123)	
• NetBIOS(137~139)	
• IMAP(143,220)	
• SNMP(161,162)	

• HTTPS(443)
• MSN(1863)
• XRD_RDP(3389)
• QQ(4000,8000)
• ICQ(5190)
• Yahoo(5050)
• BOOTP_DHCP(67,68)
• User_Define_a
• User_Define_b
• User_Define_c

Table 4-20 Descriptions of the TCP / UDP Filter Configuration Screen Objects

4.6.4 IP Address Filter

This section introduces detail information of IP Address Filter of POE Web Smart Ethernet Switch; the screen in [Figure 4-37](#) appears and [Table 4-21](#) descriptions the TCP / UDP Filter Configuration of POE Web Smart Ethernet Switch.

IP Address Filter

Set No	Select Set NO. <input type="text" value="01"/> <input type="button" value="v"/>
IP Address/ Switch Port	IP address <input type="text"/> . <input type="text"/> . <input type="text"/> . <input type="text"/> Switch Port <input type="text"/>
<input type="button" value="Add"/> <input type="button" value="Delete"/>	

Global Setting																																																	
Range	Check Source IP Addr. <input type="button" value="v"/>																																																
Rule	IP mismatch can pass <input type="button" value="v"/>																																																
Enable Port																																																	
Port NO	<table style="width: 100%; border-collapse: collapse;"> <tr> <td style="width: 12.5%; text-align: center;">01</td><td style="width: 12.5%; text-align: center;">02</td><td style="width: 12.5%; text-align: center;">03</td><td style="width: 12.5%; text-align: center;">04</td><td style="width: 12.5%; text-align: center;">05</td><td style="width: 12.5%; text-align: center;">06</td><td style="width: 12.5%; text-align: center;">07</td><td style="width: 12.5%; text-align: center;">08</td> </tr> <tr> <td style="text-align: center;"><input type="checkbox"/></td><td style="text-align: center;"><input type="checkbox"/></td><td style="text-align: center;"><input type="checkbox"/></td><td style="text-align: center;"><input type="checkbox"/></td><td style="text-align: center;"><input type="checkbox"/></td><td style="text-align: center;"><input type="checkbox"/></td><td style="text-align: center;"><input type="checkbox"/></td><td style="text-align: center;"><input type="checkbox"/></td> </tr> <tr> <td style="text-align: center;">09</td><td style="text-align: center;">10</td><td style="text-align: center;">11</td><td style="text-align: center;">12</td><td style="text-align: center;">13</td><td style="text-align: center;">14</td><td style="text-align: center;">15</td><td style="text-align: center;">16</td> </tr> <tr> <td style="text-align: center;"><input type="checkbox"/></td><td style="text-align: center;"><input type="checkbox"/></td><td style="text-align: center;"><input type="checkbox"/></td><td style="text-align: center;"><input type="checkbox"/></td><td style="text-align: center;"><input type="checkbox"/></td><td style="text-align: center;"><input type="checkbox"/></td><td style="text-align: center;"><input type="checkbox"/></td><td style="text-align: center;"><input type="checkbox"/></td> </tr> <tr> <td style="text-align: center;">17</td><td style="text-align: center;">18</td><td style="text-align: center;">19</td><td style="text-align: center;">20</td><td style="text-align: center;">21</td><td style="text-align: center;">22</td><td style="text-align: center;">23</td><td style="text-align: center;">24</td> </tr> <tr> <td style="text-align: center;"><input type="checkbox"/></td><td style="text-align: center;"><input type="checkbox"/></td><td style="text-align: center;"><input type="checkbox"/></td><td style="text-align: center;"><input type="checkbox"/></td><td style="text-align: center;"><input type="checkbox"/></td><td style="text-align: center;"><input type="checkbox"/></td><td style="text-align: center;"><input type="checkbox"/></td><td style="text-align: center;"><input type="checkbox"/></td> </tr> </table>	01	02	03	04	05	06	07	08	<input type="checkbox"/>	<input type="checkbox"/>	<input type="checkbox"/>	<input type="checkbox"/>	<input type="checkbox"/>	<input type="checkbox"/>	<input type="checkbox"/>	<input type="checkbox"/>	09	10	11	12	13	14	15	16	<input type="checkbox"/>	<input type="checkbox"/>	<input type="checkbox"/>	<input type="checkbox"/>	<input type="checkbox"/>	<input type="checkbox"/>	<input type="checkbox"/>	<input type="checkbox"/>	17	18	19	20	21	22	23	24	<input type="checkbox"/>	<input type="checkbox"/>	<input type="checkbox"/>	<input type="checkbox"/>	<input type="checkbox"/>	<input type="checkbox"/>	<input type="checkbox"/>	<input type="checkbox"/>
	01	02	03	04	05	06	07	08																																									
	<input type="checkbox"/>	<input type="checkbox"/>	<input type="checkbox"/>	<input type="checkbox"/>	<input type="checkbox"/>	<input type="checkbox"/>	<input type="checkbox"/>	<input type="checkbox"/>																																									
09	10	11	12	13	14	15	16																																										
<input type="checkbox"/>	<input type="checkbox"/>	<input type="checkbox"/>	<input type="checkbox"/>	<input type="checkbox"/>	<input type="checkbox"/>	<input type="checkbox"/>	<input type="checkbox"/>																																										
17	18	19	20	21	22	23	24																																										
<input type="checkbox"/>	<input type="checkbox"/>	<input type="checkbox"/>	<input type="checkbox"/>	<input type="checkbox"/>	<input type="checkbox"/>	<input type="checkbox"/>	<input type="checkbox"/>																																										
<input type="button" value="Update"/>																																																	

Set No	IP Setting	Port NO
01	-----	--
02	-----	--
03	-----	--
04	-----	--
05	-----	--
06	-----	--
07	-----	--
08	-----	--
09	-----	--
10	-----	--

Figure 4-37 IP Address Filter Web Page Screen

Object	Description
• Set NO.	Allow to select No. 1 to 32.
• IP Address / Switch Port	Enter the IP address and Port NO. 1 to 24.
• Range	Two choices: 1. Check Source IP Address 2. Check Destination IP Address
• Rule	Four Rules: 1. IP mismatch can pass 2. IP match can pass 3. IP match and port match can pass 4. IP match and port mismatch can pass
• Port NO.	Allow to select port 1 to port 24.

Table 4-21 Descriptions of the IP Address Filter Configuration Screen Objects

4.7 Spanning Tree

This function provides Spanning Tree of POE Web Smart Ethernet Switch; the screen in [Figure 4-38](#) appears and [Table 4-22](#) descriptions the Spanning Tree of POE Web Smart Ethernet Switch.

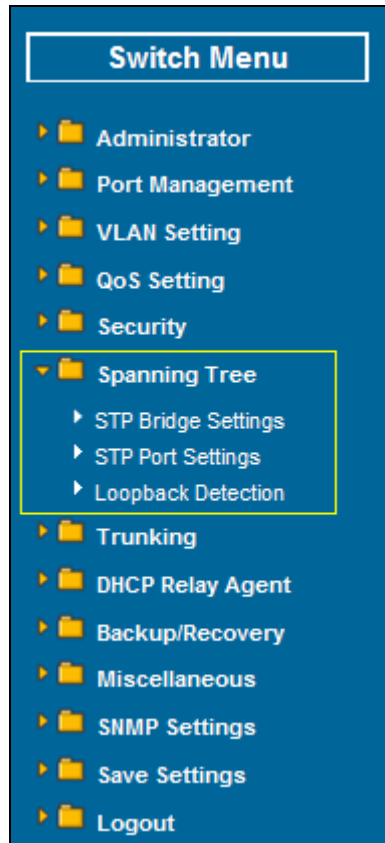

Figure 4-38 Spanning Tree Web Page Screen

The page includes the following fields:

Object	Description
<ul style="list-style-type: none"> • STP Bridge Settings 	Allow to sets STP bridge of POE Web Smart Ethernet Switch. Explained in section 4.8.1.
<ul style="list-style-type: none"> • STP Port Settings 	Allow to define STP on per port of POE Web Smart Ethernet Switch. Explained in section 4.8.2.
<ul style="list-style-type: none"> • Loopback Detection 	Allow to sets loopback detection on POE Web Smart Ethernet Switch. Explained in section 4.8.3.

Table 4-22 Descriptions of the Spanning Tree Web Page Screen Objects

4.7.1 STP Bridge Settings

This section introduces detail information of STP Bridge Settings of POE Web Smart Ethernet Switch; the screen in [Figure 4-39](#) appears and [Table 4-23](#) descriptions the STP Bridge Settings Configuration of POE Web Smart Ethernet Switch.

STP Bridge Settings

Bridge Status Setting				
STP Mode	Bridge Priority (0~61440)	Hello Time (1~10 Sec)	Max Age (6~40 Sec)	Forward Delay (4~30 Sec)
▼	<input type="text"/>	<input type="text"/>	<input type="text"/>	<input type="text"/>
<input type="button" value="Submit"/>				
<i>Note: 2*(Forward Delay-1) >= Max Age, Max Age >= 2*(Hello Time+1) Bridge Priority must be a multiple of 4096</i>				

Bridge Status				
STP Mode	Bridge ID	Hello Time	Max Age	Forward Delay
Disable	0:00 00 00 00 00 00	0	0	0

Root Status			
Root ID	Hello Time	Max Age	Forward Delay
--	--	--	--

Figure 4-39 STP Bridge Settings Web Page Screen

The page includes the following fields:

Object	Description
<ul style="list-style-type: none"> • STP Mode 	The STP mode setting. Valid values are Disable , STP & RSTP . Default mode is Disable .

<ul style="list-style-type: none"> • Bridge Priority 	<p>The switch with the lowest value has the highest priority and is selected as the root. If the value is changed, the user must reboot the switch.</p> <p>The value must be a multiple of 4096 according to the protocol standard rule.</p>
<ul style="list-style-type: none"> • Hello Time 	<p>The time that controls the switch to send out the BPDU packet to check STP current status.</p> <p>Enter a value between 1 through 10.</p>
<ul style="list-style-type: none"> • Max Age 	<p>The number of seconds a switch waits without receiving Spanning-tree Protocol configuration messages before attempting a reconfiguration.</p> <p>Enter a value between 6 through 40.</p>
<ul style="list-style-type: none"> • Forward Delay 	<p>The number of seconds a port waits before changing from its Rapid Spanning-Tree Protocol learning and listening states to the forwarding state.</p> <p>Enter a value between 4 through 30.</p>
<ul style="list-style-type: none"> • Bridge Status 	<p>The Status of Bridge.</p>
<ul style="list-style-type: none"> • Root Status 	<p>The Status of Root.</p>

Table 4-23 Descriptions of the STP Bridge Settings Configuration Screen Objects

4.7.2 STP Port Settings

This section introduces detail information of STP Port Settings of POE Web Smart Ethernet Switch; the screen in [Figure 4-40](#) appears and [Table 4-24](#) descriptions the STP Port Settings Configuration of POE Web Smart Ethernet Switch.

STP Port Settings

STP Port Settings		
Port No.	Priority (0~240)	Root Path Cost (1~20000000) 0=AUTO
<input type="text" value=""/>	<input type="text" value=""/>	<input type="text" value=""/>
<input type="button" value="Submit"/>		
Priority must be a multiple of 16		

STP Port Status						
Port No.	RPC	Priority	State	Status	Designated Bridge	Designated Port
1	Auto:0	0x80	--	--	--	--
2	Auto:0	0x80	--	--	--	--
3	Auto:0	0x80	--	--	--	--
4	Auto:0	0x80	--	--	--	--
5	Auto:0	0x80	--	--	--	--
6	Auto:0	0x80	--	--	--	--
7	Auto:0	0x80	--	--	--	--
8	Auto:0	0x80	--	--	--	--
9	Auto:0	0x80	--	--	--	--
10	Auto:0	0x80	--	--	--	--
11	Auto:0	0x80	--	--	--	--

Figure 4-40 STP Port Settings Web Page Screen

The page includes the following fields:

Object	Description
<ul style="list-style-type: none"> • Port No. 	Allow choosing one port of POE Web Smart Ethernet Switch for further management, the available options is 01 to 24 .
<ul style="list-style-type: none"> • Priority (0~240) 	Decide which port should be blocked by setting its priority as the lowest. Enter a number between 0 and 240 . The value of priority must be the multiple of 16.
<ul style="list-style-type: none"> • Root Path Cost (1~200,000,000) 	The cost of the path to the other bridge from this transmitting bridge at the specified port. Enter a number 1 through 200,000,000 . Default value is Auto .
<ul style="list-style-type: none"> • Port No. 	The switch port number of the logical STP port.
<ul style="list-style-type: none"> • RPC 	Root Path Cost. For the Root Bridge this is zero. For all other Bridges, it is the sum of the Port Path Costs on the least cost path to the Root Bridge.
<ul style="list-style-type: none"> • Priority 	Display current priority for each port.
<ul style="list-style-type: none"> • State 	The current STP port state. The port state can be one of the following values: Alternate Back Up Root Port Designated Port
<ul style="list-style-type: none"> • Status 	The current STP port status. The port status can be one of the following values: Listening Blocking Learning Forwarding
<ul style="list-style-type: none"> • Designated Bridge 	ID of the STP gridge who designated the root port
<ul style="list-style-type: none"> • Designated Port 	Port number of the bridge from where the bridge designated the root port

Table 4-24 Descriptions of the STP Port Settings Configuration Screen Objects

4.7.3 Loopback Detection Settings

This section introduces detail information of Loopback Detection Settings of POE Web Smart Ethernet Switch; the screen in [Figure 4-41](#) appears and [Table 4-25](#) descriptions the Loopback Detection Settings Configuration of POE Web Smart Ethernet Switch.

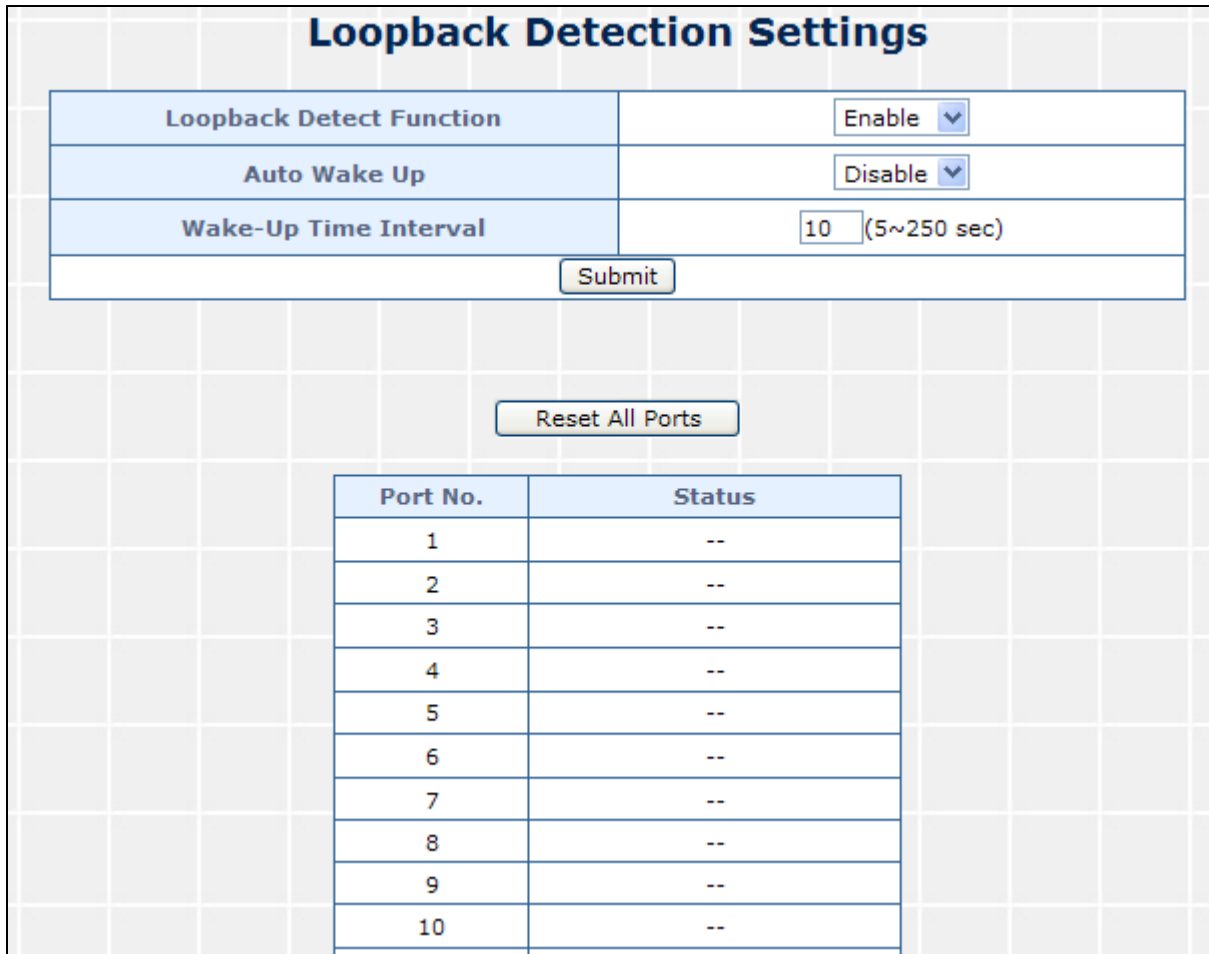

Figure 4-41 Loopback Detection Settings Web Page Screen

The page includes the following fields:

Object	Description
<ul style="list-style-type: none"> • Loopback Detect Function 	Allow to Disable or Enable the Loopback Detect Function. Default mode is Disable .
<ul style="list-style-type: none"> • Auto Wake Up 	Allow to Disable or Enable the Auto Wake Up function. Default mode is Disable .
<ul style="list-style-type: none"> • Wake-Up Time Interval 	Provide 5 ~ 250 sec different interval time for wake-up time of POE Web Smart Ethernet Switch. Default mode is 10 sec .

Table 4-25 Descriptions of the Loopback Detection Settings Configuration Screen Objects

4.8 Trunking

Port link aggregations (Port Trunking) can be used to increase the bandwidth of a network connection or to ensure fault recovery. Link aggregation lets you group up to 4 consecutive ports into a single dedicated connection between any two the Switch or other Layer 2 switches. However, before making any physical connections between devices, use the Link aggregation Configuration menu to specify the link aggregation on the devices at both ends. When using a port link aggregation, note that:

- The ports used in a link aggregation must all be of the same media type (RJ-45, 100 Mbps).
- The ports that can be assigned to the same link aggregation have certain other restrictions (see below).
- Ports can only be assigned to one link aggregation.
- The ports at both ends of a connection must be configured as link aggregation ports.
- None of the ports in a link aggregation can be configured as a mirror source port or a mirror target port.
- Enable the link aggregation prior to connecting any cable between the switches to avoid creating a data loop.
- Disconnect all link aggregation port cables or disable the link aggregation ports before removing a port link aggregation to avoid creating a data loop.

It allows a maximum of 4 ports to be aggregated at the same time and up to 2 groups. If the group is defined as a local static link aggregation group, then the number of ports must be the same as the group member ports.

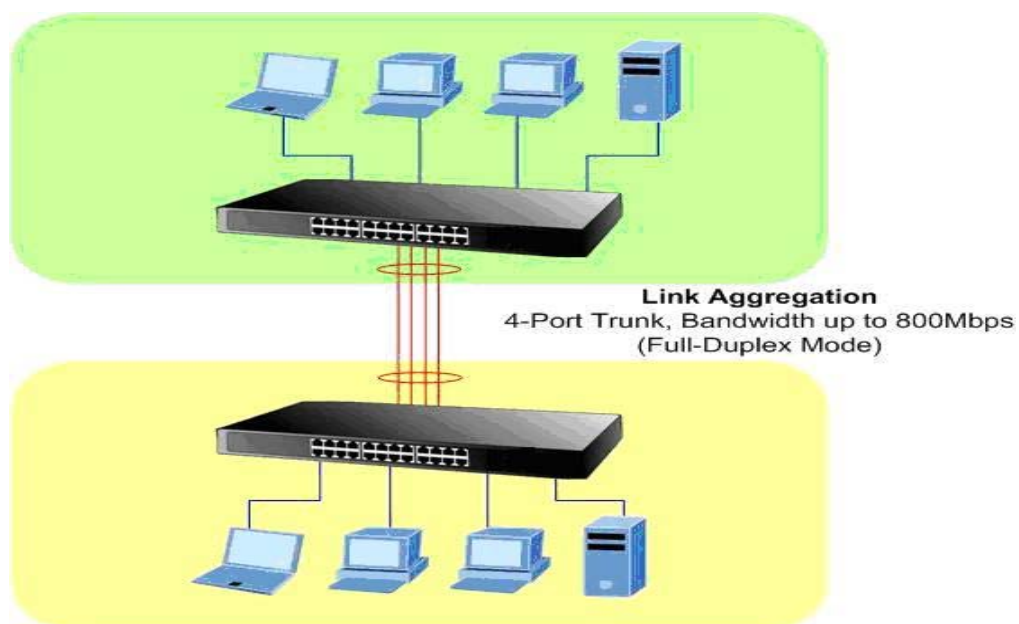

This function allows to configuring the trunk function. It provides up to two trunk groups and each trunk group provides 4 member ports. Also provide four various Trunk Hash Algorithm policies for selection. The screen in [Figure 4-42](#) appears and [Table 4-26](#) description the Trunk Setting objects of POE Web Smart Ethernet Switch.

Link Aggregation Settings

System Priority	<input type="text" value="1"/> (1~65535)
Link Aggregation Algorithm	<input type="text" value="MAC Src&Dst"/> <input type="button" value="v"/>
<input type="button" value="Submit"/>	

	Link Group 1				Link Group 2			
Member	<input type="text" value="Index 1(Port1~Port4)"/> <input type="button" value="v"/>				<input type="text" value="Index 2(Port5~Port8)"/> <input type="button" value="v"/>			
	M1	M2	M3	M4	M1	M2	M3	M4
	<input checked="" type="checkbox"/>	<input checked="" type="checkbox"/>	<input checked="" type="checkbox"/>	<input checked="" type="checkbox"/>	<input checked="" type="checkbox"/>	<input checked="" type="checkbox"/>	<input checked="" type="checkbox"/>	<input checked="" type="checkbox"/>
	--	--	--	--	--	--	--	--
State	<input type="text" value="Disable"/> <input type="button" value="v"/>				<input type="text" value="Disable"/> <input type="button" value="v"/>			
Type	<input type="text" value="LACP"/> <input type="button" value="v"/>				<input type="text" value="LACP"/> <input type="button" value="v"/>			
Operation Key	<input type="text" value="1"/> (1~65535)				<input type="text" value="2"/> (1~65535)			
Time Out	<input type="text" value="Short Time Out"/> <input type="button" value="v"/>				<input type="text" value="Short Time Out"/> <input type="button" value="v"/>			
Activity	<input type="text" value="Passive"/> <input type="button" value="v"/>				<input type="text" value="Passive"/> <input type="button" value="v"/>			
<input type="button" value="Submit"/>								

Notice: If any trunk group is set to LACP type, each port in the trunk group will not be enabled(can't Forward/Receive) until the port can finish LACP procedure withits link partner port.

Figure 4-42 Trunk Setting Web Page Screen

The page includes the following fields:

Object	Description
<ul style="list-style-type: none"> System Priority 	A value which is used to identify the active LACP. The Managed Switch with the lowest value has the highest priority and is selected as the active LACP peer of the trunk group.
<ul style="list-style-type: none"> Link Aggregation Algorithm 	Provide different algorithm method of link aggregation, the available options are shown as below: MAC Src&Dst MAC Source Default mode is MAC Src&Dst .
<ul style="list-style-type: none"> Member 	Allow to click specific port as member port from different link groups. Default link group 1 is included M1, M2, M3, M4 . Default link group 2 is included M1, M2, M3, M4 .
<ul style="list-style-type: none"> State 	Allow disable or enable port trunk from POE Web Smart Ethernet Switch, the available options are Enable and Disable . Default mode is Disable .

<ul style="list-style-type: none"> • Type 	<p>Allow to selects port trunk type from POE Web Smart Ethernet Switch, the available options are LACP and Static. Default mode is LACP.</p>
<ul style="list-style-type: none"> • Operation Key 	<p>The LACP operation key must be set to the same value for ports that belong to the same LAG.</p> <p>Range: 1-65535;</p> <p>Default Link Group 1: 1</p> <p>Default Link Group 2: 2</p>
<ul style="list-style-type: none"> • Time Out 	<p>The time out configuration mode command assigns an administrative LACP timeout. To reset the default administrative LACP timeout use the no form of this command, the available options are shown as below:</p> <p>Long Time Out</p> <p>Short Time Out</p> <p>Default mode is Short Time Out.</p>
<ul style="list-style-type: none"> • Activity 	<p>Allow link group to automatically sends LACP protocol packets or not. Default mode is Passive.</p>

Table 4-26 Descriptions of the Trunk Setting Screen Objects

4.9 DHCP Relay Agent

This function provides DHCP Relay Agent of POE Web Smart Ethernet Switch; the screen in [Figure 4-43](#) appears and [Table 4-27](#) descriptions the DHCP Relay Agent of POE Web Smart Ethernet Switch.

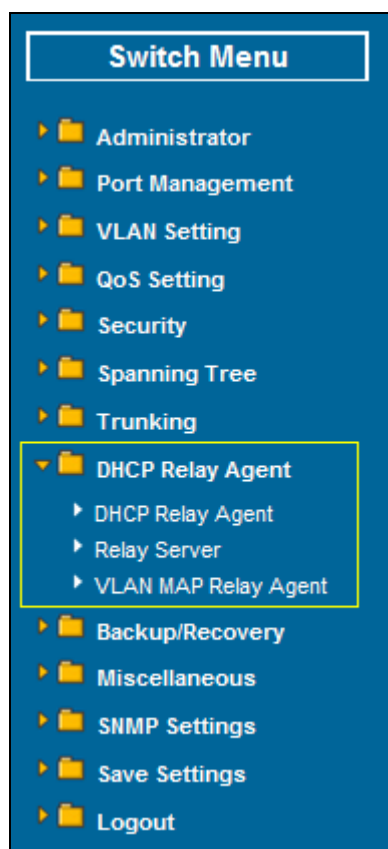

Figure 4-43 DHCP Relay Agent Web Page Screen

The page includes the following fields:

Object	Description
• DHCP Relay Agent	Allow to sets DHCP Relay Agent of POE Web Smart Ethernet Switch. Explained in section 4.9.1.
• Relay Server	Allow to sets Relay Server of POE Web Smart Ethernet Switch. Explained in section 4.9.2.
• VLAN MAP Relay Agent	Allow define VLAN MAP Relay Agent of POE Web Smart Ethernet Switch. Explained in section 4.9.3.

Table 4-27 Descriptions of the DHCP Relay Agent Web Page Screen Objects

4.9.1 DHCP Relay Agent

This section introduces detail information of DHCP Relay Agent of POE Web Smart Ethernet Switch; the screen in [Figure 4-44](#) appears and [Table 4-28](#) descriptions the STP Bridge Settings Configuration of POE Web Smart Ethernet Switch.

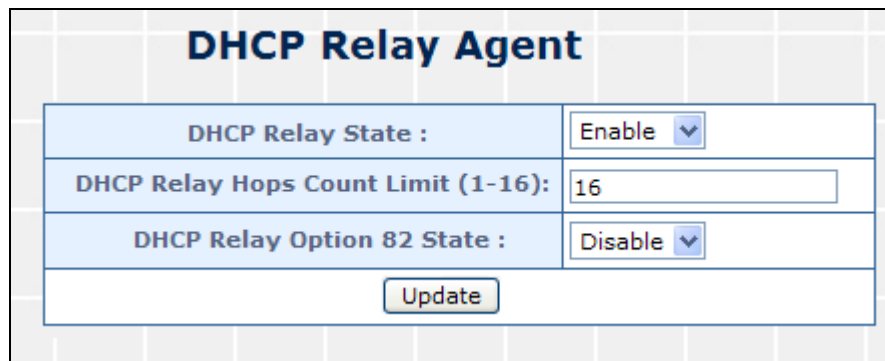

Figure 4-44 DHCP Relay Agent Web Page Screen

The page includes the following fields:

Object	Description
• DHCP Relay State	Allow to Disable or Enable the DHCP Relay State Function. Default mode is Disable .
• DHCP Relay Hops Count Limit (1-16)	This field allows an entry between 1 and 16 to define the maximum number of router hops DHCP/BOOTP messages can be forwarded across. The default hop count is 16 .
• DHCP Relay Option 82 State	Allow to Disable or Enable the DHCP Relay Option 82 State Function. Default mode is Disable .

Table 4-28 Descriptions of the DHCP Relay Agent Configuration Screen Objects

4.9.2 Relay Server

This section introduces detail information of Relay Server of POE Web Smart Ethernet Switch; the screen in [Figure 4-45](#) appears and [Table 4-29](#) descriptions the Relay Server Configuration of POE Web Smart Ethernet Switch.

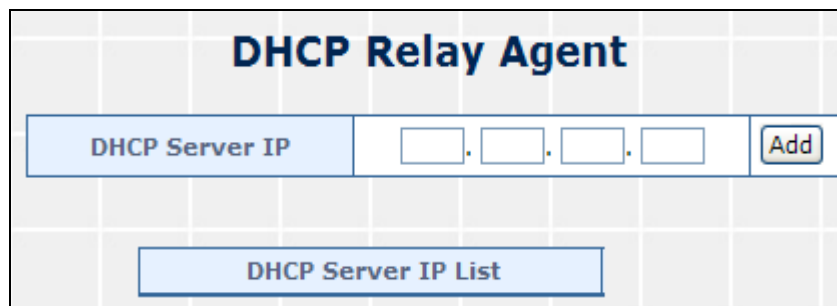

Figure 4-45 Relay Server Web Page Screen

The page includes the following fields:

Object	Description
• DHCP Server IP	Assign the DHCP Server IP address.

Table 4-29 Descriptions of Relay Server Configuration Screen Objects

4.9.3 VLAN MAP Relay Agent

This section introduces detail information of VLAN MAP Relay Agent of POE Web Smart Ethernet Switch; the screen in [Figure 4-46](#) appears and [Table 4-30](#) descriptions the VLAN MAP Relay Agent Configuration of POE Web Smart Ethernet Switch.

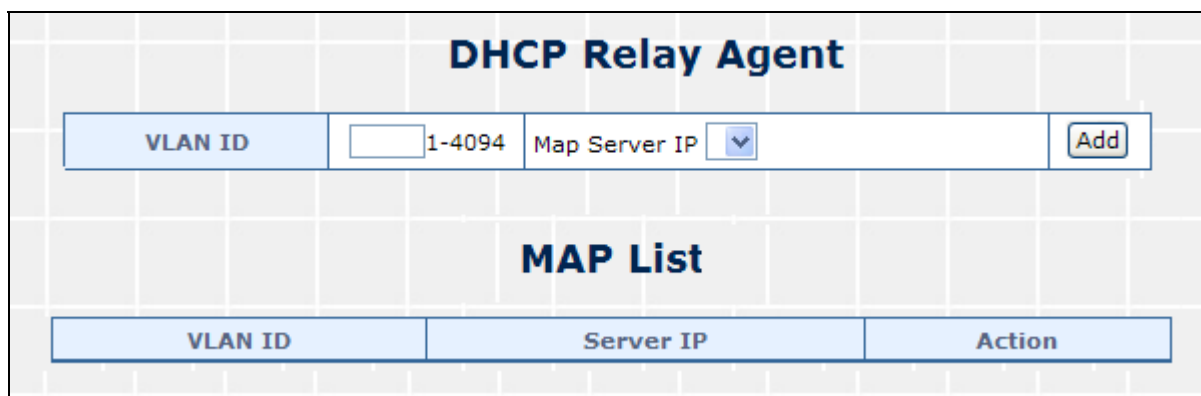

Figure 4-46 VLAN MAP Relay Agent Web Page Screen

The page includes the following fields:

Object	Description
• VLAN ID	The VLAN ID for the entry.
• Map Server IP	Select the server IP that you want to filter.

Table 4-30 Descriptions of the VLAN MAP Relay Agent Configuration Screen Objects

4.10 Backup/Recovery

This function provides Backup/Recovery of POE Web Smart Ethernet Switch; the screen in [Figure 4-47](#) appears and [Table 4-31](#) descriptions the Backup/Recovery of POE Web Smart Ethernet Switch.

Figure 4-47 Backup/Recovery Web Page Screen

The page includes the following fields:

Object	Description
<ul style="list-style-type: none"> • Backup (Switch → PC) 	Allow to backup current configuration to PC.
<ul style="list-style-type: none"> • Recovery (PC → Switch) 	Allow to recovery current configuration to switch. Use “Browser” button to select file which you want to reload to switch and type in the switch password.

Table 4-31 Descriptions of the Backup/Recovery Screen Objects

4.11 Miscellaneous

This function provides Miscellaneous of POE Web Smart Ethernet Switch; the screen in [Figure 4-48](#) appears and [Table 4-32](#) descriptions the Miscellaneous of POE Web Smart Ethernet Switch.

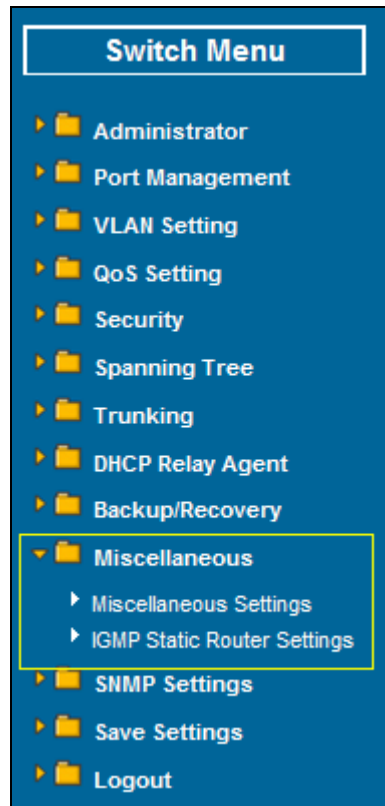

Figure 4-48 Miscellaneous Web Page Screen

The page includes the following fields:

Object	Description
<ul style="list-style-type: none"> Miscellaneous Settings 	Allow to sets DHCP Relay Agent of POE Web Smart Ethernet Switch. Explained in section 4.11.1.
<ul style="list-style-type: none"> IGMP Static Router Settings 	Allow to sets IGMP Static Router Settings of POE Web Smart Ethernet Switch. Explained in section 4.11.2.

Table 4-32 Descriptions of the Miscellaneous Screen Objects

4.11.1 Miscellaneous Settings

This function provides Miscellaneous Settings of POE Web Smart Ethernet Switch; the screen in [Figure 4-49](#) appears and [Table 4-33](#) descriptions the Miscellaneous Settings of POE Web Smart Ethernet Switch.

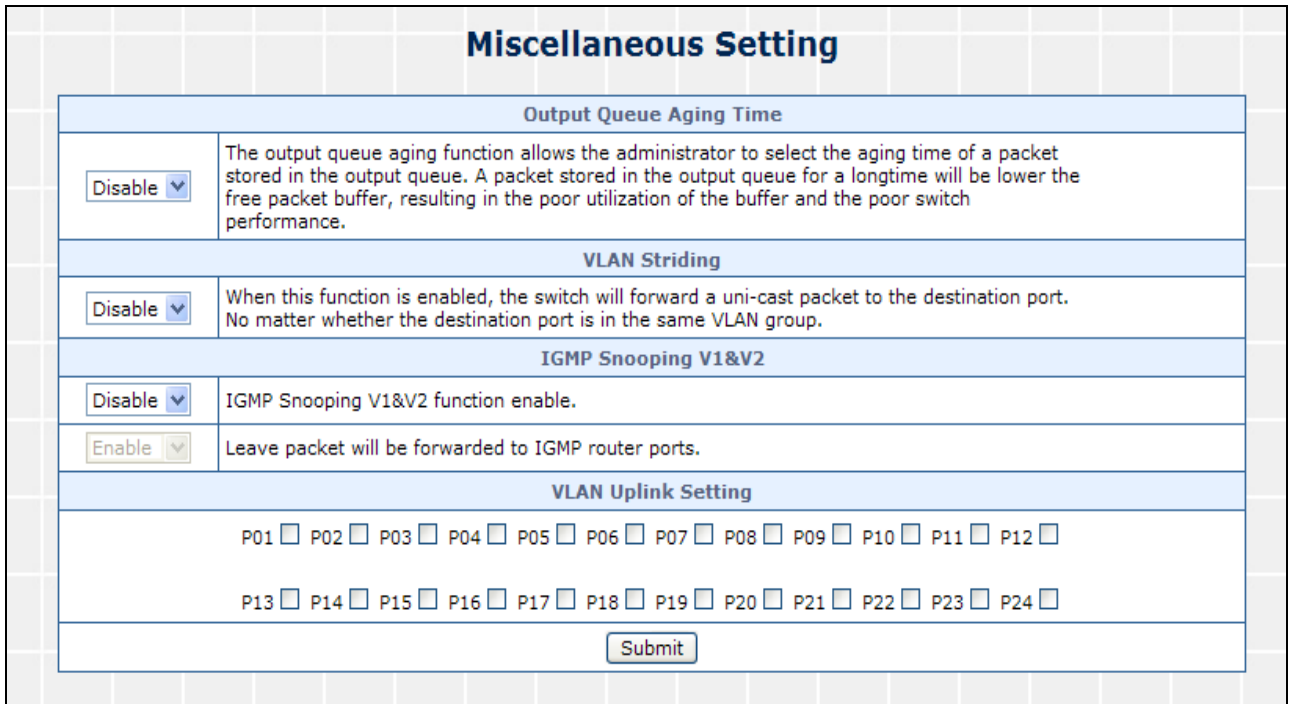

Figure 4-49 Misc Operation Web Page Screen

The page includes the following fields:

Object	Description
<ul style="list-style-type: none"> • Output Queue Aging Time 	Allow define the Output Queue Aging Time of POE Web Smart Ethernet Switch; the available options are Disable , 200ms , 400ms , 600ms and 800ms . Default mode is Disable .
<ul style="list-style-type: none"> • VLAN Striding 	Allow Disable or Enable the VLAN Striding function of POE Web Smart Ethernet Switch. Default mode is Disable .
<ul style="list-style-type: none"> • IGMP Snooping V1 & V2 	Allow Disable or Enable the IGMP Snooping V1 & V2 function of POE Web Smart Ethernet Switch. Default mode is Disable .
<ul style="list-style-type: none"> • VLAN Uplink Setting 	Allow different VLAN use their individual uplink port to forward packets. In a normal application, “only one “uplink port can be selected in a switch.

Table 4-33 Descriptions of the Misc Operation Screen Objects

4.11.2 IGMP Static Router Settings

This function provides IGMP Static Router Settings of POE Web Smart Ethernet Switch; the screen in [Figure 4-50](#) appears and [Table 4-34](#) descriptions the IGMP Static Router Settings of POE Web Smart Ethernet Switch.

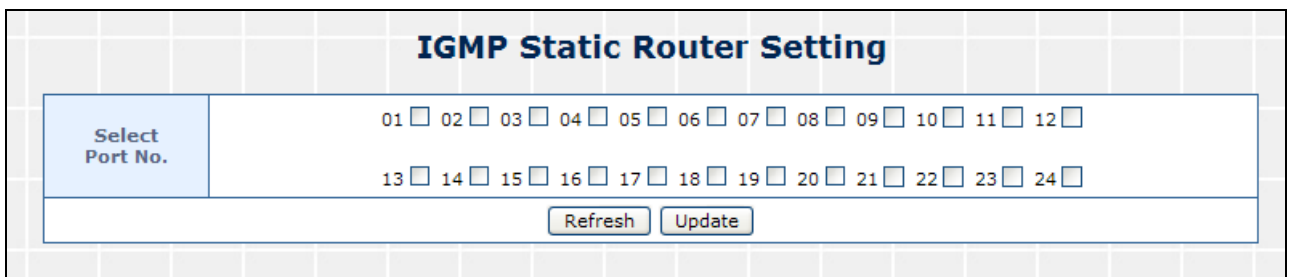

Figure 4-50 Misc Operation Web Page Screen

The page includes the following fields:

Object	Description
<ul style="list-style-type: none"> • Select Port No. 	Allow to select specific port for IGMP Static feature

Table 4-34 Descriptions of the IGMP Static Router Settings Screen Objects

4.12 SNMP Settings

This function provides SNMP Settings of POE Web Smart Ethernet Switch; the screen in [Figure 4-51](#) appears and [Table 4-35](#) descriptions the SNMP Settings of POE Web Smart Ethernet Switch.

Figure 4-51 SNMP Settings Web Page Screen

The page includes the following fields:

Object	Description
<ul style="list-style-type: none"> • Community Name 	Indicates the community name.
<ul style="list-style-type: none"> • Access Right 	Defines the group access rights. The possible field values are: Read/Write Read Only
<ul style="list-style-type: none"> • System Description 	An administratively assigned name for this managed node. Default description is FNSW-2400PS .

• System Contact	The textual identification of the contact person for this managed node. Default contact is Planet .
• System Location	The physical location of this node (e.g., telephone closet, 3rd floor). Default contact is Planet .
• Trap State	Allow Disable or Enable the trap state function of POE Web Smart Ethernet Switch. Default mode is Enable .

Table 4-35 Descriptions of the SNMP Settings Screen Objects

4.13 Save Settings

This section provide Web Save Settings function on POE Web Smart Ethernet Switch, after choose this function and the following screen appears in [Figure 4-52](#). Please press “**Save**” button to save all of settings of the switch. Otherwise, the switch will use the last time saved values after rebooted.

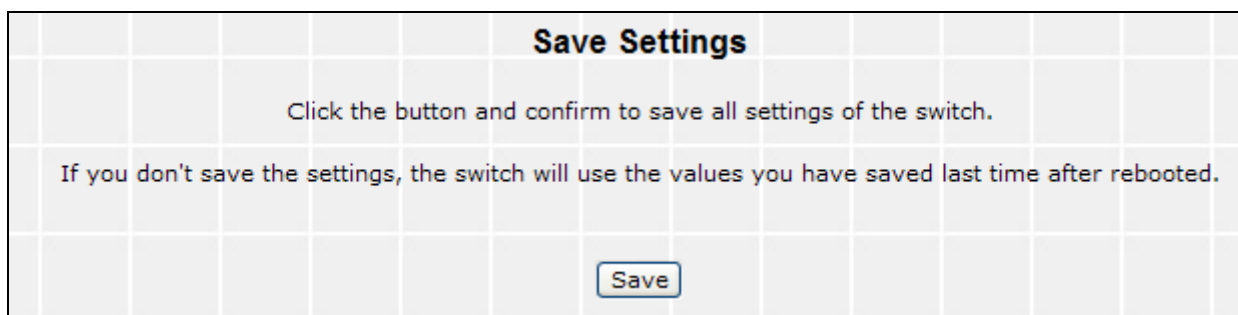

Figure 4-52 Save Settings Page Screen

4.14 Logout

This section provide Web logout function on POE Web Smart Ethernet Switch, after choose this function and the following screen appears in [Figure 4-53](#). Please press “**Yes**” button to take effect and Login Web Screen appears. Please re-login the POE Web Smart Ethernet Switch for further management.

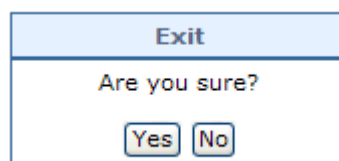

Figure 4-53 Logout Web Page Screen

5. SWITCH OPERATION

5.1 Address Table

The Switch is implemented with an address table. This address table composed of many entries. Each entry is used to store the address information of some node in network, including MAC address, port no, etc. This information comes from the learning process of Ethernet Switch.

5.2 Learning

When one packet comes in from any port. The Switch will record the source address, port no. And the other related information in address table. This information will be used to decide either forwarding or filtering for future packets.

5.3 Forwarding & Filtering

When one packet comes from some port of the Ethernet Switching, it will also check the destination address besides the source address learning. The Ethernet Switching will lookup the address-table for the destination address. If not found, this packet will be forwarded to all the other ports except the port which this packet comes in. And these ports will transmit this packet to the network it connected. If found, and the destination address is located at different port from this packet comes in, the Ethernet Switching will forward this packet to the port where this destination address is located according to the information from address table. But, if the destination address is located at the same port with this packet comes in, then this packet will be filtered. Thereby increasing the network throughput and availability.

5.4 Store-and-Forward

Store-and-Forward is one type of packet-forwarding techniques. A Store-and Forward Ethernet Switching stores the incoming frame in an internal buffer, do the complete error checking before transmission. Therefore, no error packets occurrence, it is the best choice when a network needs efficiency and stability.

The Ethernet Switch scans the destination address from the packet-header, searches the routing table provided for the incoming port and forwards the packet, only if required. The fast forwarding makes the switch attractive for connecting servers directly to the network, thereby increasing throughput and availability. However, the switch is most commonly used to segment existing hubs, which nearly always improves overall performance. An Ethernet Switching can be easily configured in any Ethernet network environment to significantly boost bandwidth using conventional cabling and adapters.

Due to the learning function of the Ethernet switching, the source address and corresponding port number of each incoming and outgoing packet are stored in a routing table. This information is subsequently used to filter packets whose destination address is on the same segment as the source address. This confines network traffic to its respective domain, reducing the overall load on the network.

The Switch performs "Store and forward" therefore, no error packets occur. More reliably, it reduces the re-transmission rate. No packet loss will occur.

5.5 Auto-Negotiation

The STP ports on the Switch have built-in "Auto-negotiation". This technology automatically sets the best possible bandwidth when a connection is established with another network device (usually at Power On or Reset). This is done by detect the modes and speeds at the second of both device is connected and capable of, both 10Base-T and 100Base-TX devices can connect with the port in either Half- or Full-Duplex mode.

6. POWER OVER ETHERNET OVERVIEW

What is PoE?

Based on the global standard IEEE 802.3af, PoE is a technology for wired Ethernet, the most widely installed local area network technology adopted today. PoE allows the electrical power necessary for the operation of each end-device to be carried by data cables rather than by separate power cords. New network applications, such as IP Cameras, VoIP Phones, and Wireless Networking, can help enterprises improve productivity. It minimizes wires that must be used to install the network for offering lower cost, and less power failures.

IEEE802.3af also called Data Terminal equipment (DTE) power via Media dependent interface (MDI) is an international standard to define the transmission for power over Ethernet. The 802.3af is delivering 48V power over RJ-45 wiring. Besides 802.3af also define two types of source equipment: Mid-Span and End-Span.

■ Mid-Span

Mid-Span device is placed between legacy switch and the powered device. Mid-Span is tap the unused wire pairs 4/5 and 7/8 to carry power, the other four is for data transmit.

■ End-Span

End-Span device is direct connecting with power device. End-Span could also tap the wire 1/2 and 3/6.

PoE System Architecture

The specification of PoE typically requires two devices: the **Powered Source Equipment (PSE)** and the **Powered Device (PD)**. The PSE is either an End-Span or a Mid-Span, while the PD is a PoE-enabled terminal, such as IP Phones, Wireless LAN, etc. Power can be delivered over data pairs or spare pairs of standard CAT-5 cabling.

How Power is Transferred Through the Cable

A standard CAT5 Ethernet cable has four twisted pairs, but only two of these are used for 10BASE-T and 100BASE-T. The specification allows two options for using these cables for power, shown in Figure 2 and Figure 3:

The spare pairs are used. Figure 2 shows the pair on pins 4 and 5 connected together and forming the positive / negative supply, and the pair on pins 7 and 8 connected and forming the positive / negative supply. (In fact, a late change to the spec allows either polarity to be used).

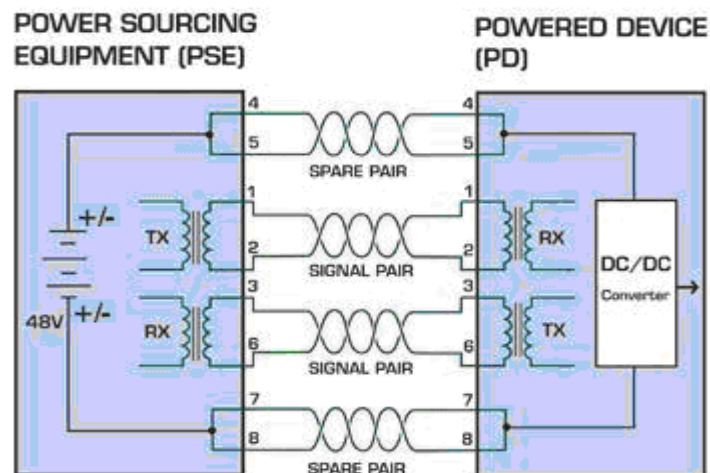

Figure 1 - Power Supplied over the Spare Pins

The data pairs are used. Since Ethernet pairs are transformer coupled at each end, it is possible to apply DC power to the center tap of the isolation transformer without upsetting the data transfer. In this mode of operation the pair on pins 3 and 6 and the pair on pins 1 and 2 can be of either polarity.

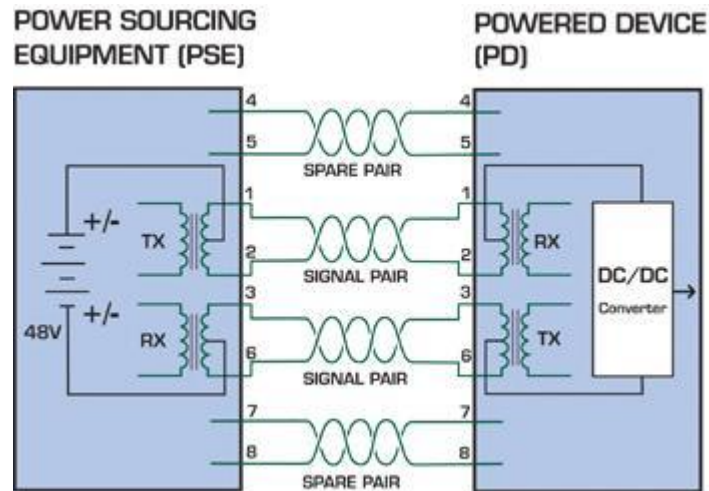

Figure 2 - Power Supplied over the Data Pins

When to install PoE?

Consider the following scenarios:

- You're planning to install the latest VoIP Phone system to minimize cabling building costs when your company moves into new offices next month.
- The company staff has been clamoring for a wireless access point in the picnic area behind the building so they can work on their laptops through lunch, but the cost of electrical power to the outside is not affordable.
- Management asks for IP Surveillance Cameras and business access systems throughout the facility, but they would rather avoid another electrician's payment.

References:

IEEE Std 802.3af-2003 (Amendment to IEEE Std 802.3-2002, including IEEE Std 802.3ae-2002), 2003 Page(s):0_1-121

White Paper on Power over Ethernet (IEEE802.3af)

http://www.poweroverethernet.com/articles.php?article_id=52

Microsemi /PowerDsine

<http://www.microsemi.com/PowerDsine/>

Linear Tech

<http://www.linear.com/>

7. THE POE PROVISION PROCESS

While adding PoE support to networked devices is relatively painless, it should be realized that power cannot simply be transferred over existing CAT-5 cables. Without proper preparation, doing so may result in damage to devices that are not designed to support provision of power over their network interfaces.

The PSE is the manager of the PoE process. In the beginning, only small voltage level is induced on the port's output, till a valid PD is detected during the Detection period. The PSE may choose to perform classification, to estimate the amount of power to be consumed by this PD. After a time-controlled start-up, the PSE begins supplying the 48 VDC level to the PD, till it is physically or electrically disconnected. Upon disconnection, voltage and power shut down.

Since the PSE is responsible for the PoE process timing, it is the one generating the probing signals prior to operating the PD and monitoring the various scenarios that may occur during operation.

All probing is done using voltage induction and current measurement in return.

Stages of powering up a PoE link

Stage	Action	Volts specified per 802.3af	Volts managed by chipset
Detection	Measure whether powered device has the correct signature resistance of 15–33 kΩ	2.7-10.0	1.8–10.0
Classification	Measure which power level class the resistor indicates	14.5-20.5	12.5–25.0
Startup	Where the powered device will startup	>42	>38
Normal operation	Supply power to device	36-57	25.0–60.0

7.1 Line Detection

Before power is applied, safety dictates that it must first be ensured that a valid PD is connected to the PSE's output. This process is referred to as "line detection", and involves the PSE seeking a specific, 25 KΩ signature resistor. Detection of this signature indicates that a valid PD is connected, and that provision of power to the device may commence.

The signature resistor lies in the PD's PoE front-end, isolated from the rest of the the PD's circuitries till detection is certified.

7.2 Classification

Once a PD is detected, the PSE may optionally perform classification, to determine the maximal power a PD is to consume. The PSE induces 15.5-20.5 VDC, limited to 100 mA, for a period of 10 to 75 ms responded by a certain current consumption by the PD, indicating its power class.

The PD is assigned to one of 5 classes: 0 (default class) indicates that full 15.4 watts should be provided, 1-3 indicate various required power levels and 4 is reserved for future use. PDs that do not support classification are assigned to class 0. Special care must be employed in the definition of class thresholds, as classification may be affected by cable losses.

Classifying a PD according to its power consumption may assist a PoE system in optimizing its power distribution. Such a system typically suffers from lack of power resources, so that efficient power management based on classification results may reduce total system costs.

7.3 Start-up

Once line detection and optional classification stages are completed, the PSE must switch from low voltage to its full voltage capacity (44-57 Volts) over a minimal amount of time (above 15 microseconds).

A gradual startup is required, as a sudden rise in voltage (reaching high frequencies) would introduce noise on the data lines.

Once provision of power is initiated, it is common for inrush current to be experienced at the PSE port, due to the PD's input capacitance. A PD must be designed to cease inrush current consumption (of over 350 mA) within 50 ms of power provision startup.

7.4 Operation

During normal operation, the PSE provides 44-57 VDC, able to support a minimum of 15.4 watts power.

Power Overloads

The IEEE 802.3af standard defines handling of overload conditions. In the event of an overload (a PD drawing a higher power level than the allowed 12.95 Watts), or an outright short circuit caused by a failure in cabling or in the PD, the PSE must shut down power within 50 to 75 milliseconds, while limiting current drain during this period to protect the cabling infrastructure. Immediate voltage drop is avoided to prevent shutdown due to random fluctuations.

7.5 Power Disconnection Scenarios

The IEEE 802.3af standard requires that devices powered over Ethernet be disconnected safely (i.e. power needs be shut down within a short period of time following disconnection of a PD from an active port).

When a PD is disconnected, there is a danger that it will be replaced by a non-PoE-ready device while power is still on. Imagine disconnecting a powered IP phone utilizing 48 VDC, then inadvertently plugging the powered Ethernet cable into a non-PoE notebook computer. What's sure to follow is not a pretty picture.

The standard defines two means of disconnection, DC Disconnect and AC Disconnect, both of which provide the same functionality - the PSE shuts down power to a disconnected port within 300 to 400ms. The upper boundary is a physical human limit for disconnecting one PD and reconnecting another.

DC Disconnect

DC Disconnect detection involves measurement of current. Naturally, a disconnected PD stops consuming current, which can be inspected by the PSE. The PSE must therefore disconnect power within 300 to 400 ms from the current flow stop. The lower time boundary is important to prevent shutdown due to random fluctuations.

AC Disconnect

This method is based on the fact that when a valid PD is connected to a port, the AC impedance measured on its terminals is significantly lower than in the case of an open port (disconnected PD).

AC Disconnect detection involves the induction of low AC signal in addition to the 48 VDC operating voltage. The returned AC signal amplitude is monitored by the PSE at the port terminals. During normal operation, the PD's relatively low impedance lowers the returned AC signal while a sudden disconnection of this PD will cause a surge to the full AC signal level and will indicate PD disconnection.

8. TROUBLESHOOTING

This chapter contains information to help you solve problems. If the Switch is not functioning properly, make sure the Ethernet Switch was set up according to instructions in this manual.

The Link LED is not light

Solution:

Check the cable connection and remove duplex mode of the Switch.

Some stations can not talk to other stations located on the other port

Solution:

Please check the VLAN, port trunking function that may introduce this kind of problem.

Performance is bad

Solution:

Check the full duplex status of the Ethernet Switch. If the Ethernet Switch is set to full duplex and the partner is set to half duplex, then the performance will be poor.

100Base-TX port link LED is light, but the traffic is irregular

Solution:

Check that the attached device is not set to dedicate full duplex. Some devices use a physical or software switch to change duplex modes. Auto-negotiation may not recognize this type of full-duplex setting.

Why the Switch doesn't connect to the network

Solution:

Check the LNK/ACT LED on the switch Try another port on the Switch Make sure the cable is installed properly Make sure the cable is the right type Turn off the power. After a while, turn on power again.

How to deal forgotten password situation of FNSW-2400PS?

Solution:

Please press Reset button at front panel for 5 seconds then the POE Web Smart Ethernet Switch will reset to factory default mode(**Username and Password: admin**)

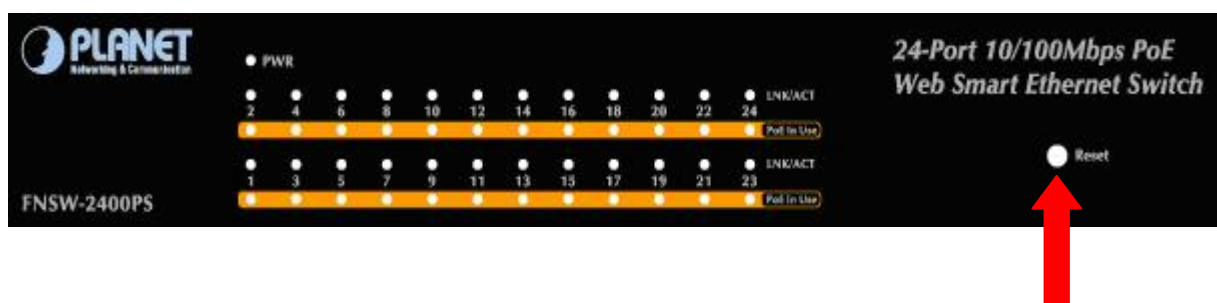

APPENDIX A NETWORKING CONNECTION

A.1 Switch's RJ-45 Pin Assignments

10/100Mbps, 10/100Base-TX

RJ-45 Connector pin assignment		
Contact	MDI Media Dependant In- terface	MDI-X Media Dependant Interface -Cross
1	Tx + (transmit)	Rx + (receive)
2	Tx - (transmit)	Rx - (receive)
3	Rx + (receive)	Tx + (transmit)
4, 5	Not used	
6	Rx - (receive)	Tx - (transmit)
7, 8	Not used	

A.2 RJ-45 cable pin assignment

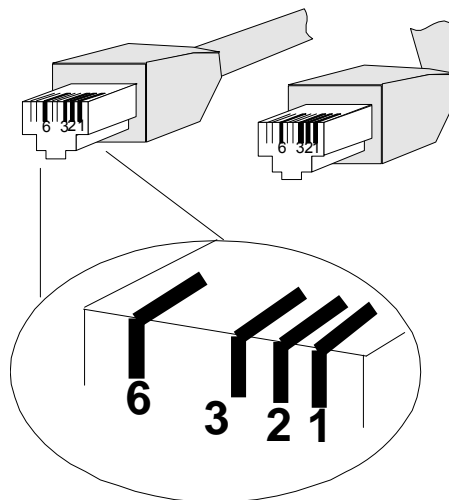

The standard RJ-45 receptacle/connector

There are 8 wires on a standard UTP/STP cable and each wire is color-coded. The following shows the pin allocation and color of straight cable and crossover cable connection:

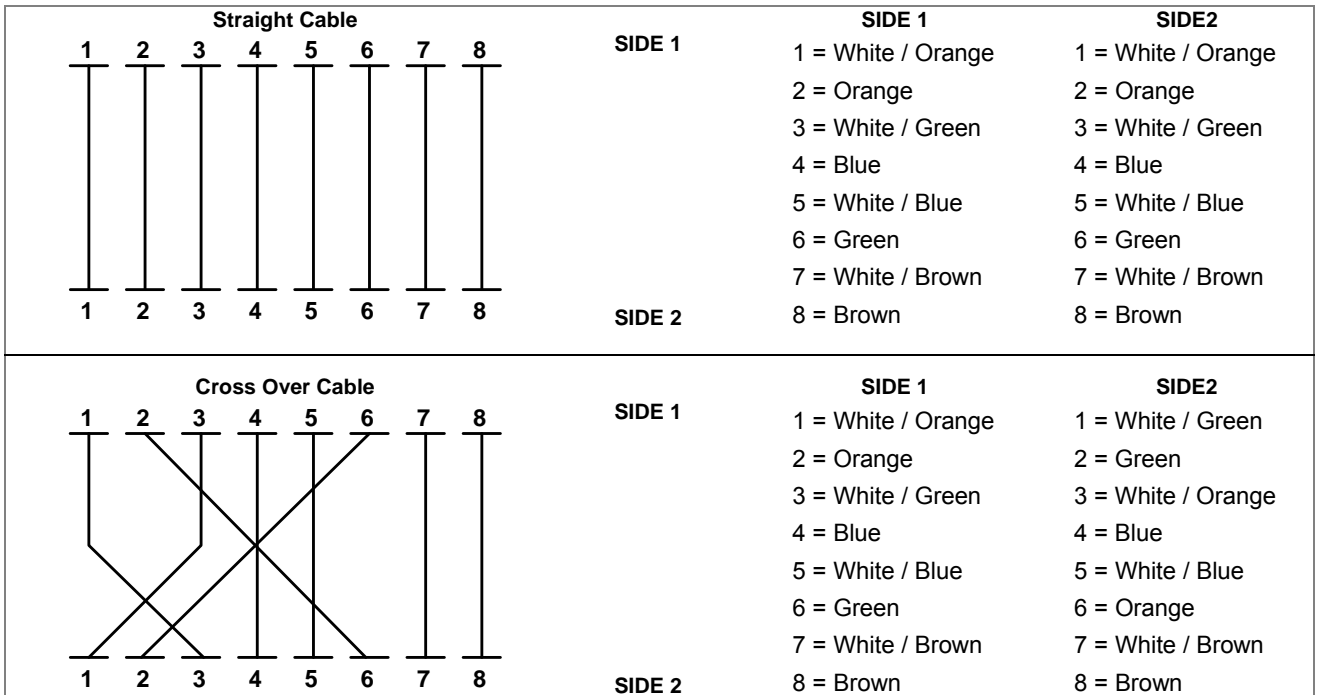
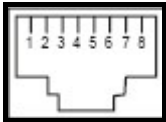

Figure A-1: Straight-Through and Crossover Cable

Please make sure your connected cables are with same pin assignment and color as above picture before deploying the cables into your network.

A.3 DATA OUT PoE Injector RJ-45 Port Pin Assignments

	PIN NO	RJ-45 SIGNAL ASSIGNMENT
	1	Output Transmit Data +
	2	Output Transmit Data -
	3	Receive Data +
	4	Negative Power -
	5	Negative Power -
	6	Receive Data -
	7	Positive Power +
	8	Positive Power +

EC Declaration of Conformity

For the following equipment:

*Type of Product: FNSW-2400PS

*Model Number: 24-Port 10/100Mbps PoE Web Smart Ethernet Switch

* Produced by:

Manufacturer's Name : **Planet Technology Corp.**

Manufacturer's Address: 10F., No.96, Minquan Rd., Xindian Dist.,
New Taipei City 231, Taiwan (R.O.C.).

is herewith confirmed to comply with the requirements set out in the Council Directive on the Approximation of the Laws of the Member States relating to Electromagnetic Compatibility Directive on (2004/108/EC).

For the evaluation regarding the EMC, the following standards were applied:

EN 55022	(2006+A1:2007, Class A)
EN 61000-3-2	(2006+A2:2009)
EN 61000-3-3	(2008)
EN 55024	(1998 + A1: 2001 + A2: 2003)
IEC 61000-4-2	(2008)
IEC 61000-4-3	(2006 + A1:2007 + A2:2010)
IEC 61000-4-4	(2004 + A1:2010)
IEC 61000-4-5	(2005)
IEC 61000-4-6	(2008)
IEC 61000-4-8	(2009)
IEC 61000-4-11	(2004)

Responsible for marking this declaration if the:

Manufacturer **Authorized representative established within the EU**

Authorized representative established within the EU (if applicable):

Company Name: Planet Technology Corp.

Company Address: 10F., No.96, Minquan Rd., Xindian Dist., New Taipei City 231, Taiwan (R.O.C.)

Person responsible for making this declaration

Name, Surname Kent Kang

Position / Title : Product Manager

Taiwan
Place

17st Oct., 2011
Date

Legal Signature

PLANET TECHNOLOGY CORPORATION

e-mail: sales@planet.com.tw http://www.planet.com.tw

10F., No.96, Minquan Rd., Xindian Dist., New Taipei City, Taiwan, R.O.C. Tel:886-2-2219-9518 Fax:886-2-2219-9528