

8-Port 10/100Mbps 802.3at PoE Desktop Switch

FSD-808HP

User's Manual

Trademarks

Copyright © PLANET Technology Corp. 2012.

Contents subject to revision without prior notice.

PLANET is a registered trademark of PLANET Technology Corp. All other trademarks belong to their respective owners.

Disclaimer

PLANET Technology does not warrant that the hardware will work properly in all environments and applications, and makes no warranty and representation, either implied or expressed, with respect to the quality, performance, merchantability, or fitness for a particular purpose.

PLANET has made every effort to ensure that this User's Manual is accurate; PLANET disclaims liability for any inaccuracies or omissions that may have occurred.

Information in this User's Manual is subject to change without notice and does not represent a commitment on the part of PLANET. PLANET assumes no responsibility for any inaccuracies that may be contained in this User's Manual. PLANET makes no commitment to update or keep current the information in this User's Manual, and reserves the right to make improvements to this User's Manual and/or to the products described in this User's Manual, at any time without notice.

If you find information in this manual that is incorrect, misleading, or incomplete, we would appreciate your comments and suggestions.

FCC Warning

This equipment has been tested and found to comply with the limits for a Class B digital device, pursuant to Part 15 of the FCC Rules. These limits are designed to provide reasonable protection against harmful interference when the equipment is operated in a commercial environment. This equipment generates, uses, and can radiate radio frequency energy and, if not installed and used in accordance with the Instruction manual, may cause harmful interference to radio communications. Operation of this equipment in a residential area is likely to cause harmful interference in which case the user will be required to correct the interference at his own expense.

CE Mark Warning

This is a Class B product. In a domestic environment, this product may cause radio interference, in which case the user may be required to take adequate measures.

Energy Saving Note of the Device

This power required device does not support Standby mode operation.

For energy saving, please remove the power cable to disconnect the device from the power circuit.

Without removing power cable, the device will still consuming power from the power source. In the view of Saving the Energy and reduce the unnecessary power consuming, it is strongly suggested to remove the power connection for the device if this device is not intended to be active.

WEEE Warning



To avoid the potential effects on the environment and human health as a result of the presence of hazardous substances in electrical and electronic equipment, end users of electrical and electronic equipment should understand the meaning of the crossed-out wheeled bin symbol. Do not dispose of WEEE as unsorted municipal waste and have to collect such WEEE separately.

Revision

PLANET 8-Port 10/100Mbps 802.3at PoE Desktop Switch User's Manual

For Model: FSD-808HP

Revision: 1.0 (December 2012)

Part No.: 2351-AK3130-000

Table Of Contents

1. Introduction	5
1.1 Checklist.....	5
1.2 Product Description.....	5
1.3 Features	6
1.4 Specification.....	7
2. Hardware Description	8
2.1 Front Panel	8
2.1.1 LED Indicators	8
2.2 Rear Panel	9
3. Hardware Installation	10
3.1 Desktop Installation	10
3.2 Rack Mounting	12
3.3 Product Application	14
3.3.1 Supports IEEE 802.3af and IEEE 802.3at Standard	14
3.3.2 IP Office Department / Workgroup PoE Switch	15
3.4 Power over Ethernet Powered Device	16
4. Power Over Ethernet Overview	17
5. Troubleshooting	20
Appendix A Networking Connection	21
A.1 PoE Switch RJ-45 Port Pin Assignments	21
A.2 10/100Mbps, 10/100Base-TX	21

1. Introduction

1.1 Checklist

Check the contents of your package for following parts:

- FSD-808HP x 1
- User's Manual x 1
- 19" Rack Mount Accessory Kit x 1
- Rubber Feet x 4
- Power Cord x 1

If any of these pieces are missing or damaged, please contact your dealer immediately, if possible, retain the carton including the original packing material, and use them against to repack the product in case there is a need to return it to us for repair.

1.2 Product Description

To fulfill the demand of High Power PoE for network applications, the PLANET 802.3at PoE Fast Ethernet Switch family -FSD-808HP is an ideal solution. Each 10/100Mbps port of FSD-808HP features **IEEE 802.3af** and **High Power IEEE 802.3at** Power over Ethernet (PoE) that combines up to **140 Watts** power output and data per port over one Cat. 5E / 6 Ethernet cable, with totally **140 Watts** PoE budget on whole system, it is designed specifically to satisfy the growing demand of higher power consuming network PD (powered devices) such as **PTZ** (Pan, Tilt & Zoom) / **Speed Dome network cameras**, multi-channel (802.11a / b / g / n) wireless LAN access points and other network devices by providing double PoE power than conventional 802.3af PoE currently.

The 8 10/100Mbps High Power PoE ports in the FSD-808HP supports both 802.3af and 802.3at PoE standards and allows users flexibly connect standard and high powered devices simultaneously, the FSD-808HP offering **140 Watts** PoE budget, eight 15.4 Watts IEEE 802.3af devices or four 30 Watts IEEE 802.3at devices can be easily installed without the power-socket limitation.

To facilitate power management, the FSD-808HP equips two orange LEDs hardware designed that located on left side of FSD-808HP front panel, it call "PoE Power Usage". 1-4 is meaning that counting from port 1 to 4 of PoE output and 5-8 is meaning that counting from port 5 to 8 of PoE output. The 80% is meaning that, when 1-4 or 5-8 PoE output is over 80%, the LED will be light to advise customers. With these LED indications, you can monitor current PoE power used status of FSD-808HP easily and efficiently.

Providing data transfer and High Power PoE in one unit, the FSD-808HP shall reduce the need of extension cables and dedicated electrical outlets on the wall,

ceiling or any unreachable place. It helps to lower the installation costs and simplify the installation effort. Besides, the first important key feature is energy saving. With more efficient switching power supply, the efficiency of the FSD-808HP would be much better than eight linear power adapters in the long run. Furthermore, it is the ideal device for bridging among Fast Ethernet and Gigabit Ethernet workgroups and networks. With Gigabit throughput and eight IEEE 802.3af / 802.3at PoE interfaces supported, the FSD-808HP is ideal for small business and workgroups to efficiently deploy the High Power PoE network for the wireless access points, IP-based surveillance camera or IP phones in any places.

All RJ-45 copper interfaces in the FSD-808HP support 10/100Mbps Auto-Negotiation for optimal speed detection through RJ-45 Category 6, 5 or 5e cables. It also supports standard Auto-MDI/MDI-X that can detect the type of connection to any Ethernet device without requiring special straight or crossover cables.

1.3 Features

■ RJ-45 Interface

- 8-Port 10/100Mbps Fast Ethernet ports
- 8-Port supports 52V DC power to PoE Powered Device

■ Power over Ethernet

- Comply with IEEE 802.3af / IEEE 802.3at Power over Ethernet End-Span PSE
- Up to 8 IEEE 802.3af / IEEE 802.3at devices powered
- Supports PoE Power up to 30 Watts for each PoE port
- Auto detect powered device (PD)
- Circuit protection prevents power interference between ports
- PoE Usage Alarm LED
- Remote power feeding up to 100m

■ Switching

- Hardware based 10/100Mbps Auto-Negotiation and Auto MDI/MDI-X
- Flow control for Full Duplex operation and back pressure for Half Duplex operation
- Integrates address look-up engine, supporting 2K absolute MAC addresses
- Automatic address learning and address aging
- Supports Energy-Efficient Ethernet (EEE) function (IEEE 802.3az)

■ Hardware

- 12-inch desktop size, 1U height
- LED indicators for PoE ready, PoE activity and PoE Usage Alarm
- Fanless design

1.4 Specification

Model	FSD-808HP 8-Port 10/100Mbps 802.3at PoE Desktop Switch
Hardware Specification	
Network Connector	8-Port RJ-45 for 10/100Base-TX
PoE Inject Port	8-Port with 802.3af / 802.3at PoE injector function
LED Display	System: Power (Green) PoE Usage Alarm: 1-4 (Orange) 5-8 (Orange) Per port : PoE in-use (Green) LNK/ACT (Green)
Switch Architecture	Store and Forward switch architecture
MAC Address	2K MAC address table with Auto learning function
Switch Fabric	1.6Gbps
Switch Throughput	1.19Mpps@64Bytes
Power Requirement	AC 100~240V, 50/60Hz, 2A max.
Power Consumption	Max. 150 Watts / 511 BTU
Dimension (W x D x H)	280 x 180 x 44 mm
Weight	1.65kg
Power over Ethernet	
PoE Standard	IEEE 802.3af Power over Ethernet / PSE IEEE 802.3at Enhancement Power over Ethernet / PSE
PoE Power Supply Type	End-Span
PoE Power Output	Per Port 52V DC Max. 30.8 Watts
Power Pin Assignment	1/2(+), 3/6(-)
PoE Power Budget	140 Watts
Environment	
Operating environment	0 ~ 50 Degree C
Storage environment	-40 ~ 70 Degree C
Operating Humidity	5 ~ 95%, relative humidity, non-condensing
Storage Humidity	5 ~ 95%, relative humidity, non-condensing
Standard Conformance	
Standard Compliance	IEEE 802.3 Ethernet IEEE 802.3u Fast Ethernet IEEE 802.3x Flow Control IEEE 802.3af Power over Ethernet IEEE 802.3at Enhancement Power over Ethernet IEEE 802.3az Energy-Efficient Ethernet
EMI Safety	FCC Class B, CE

2. Hardware Description

This product provides two different running speeds – 10Mbps and 100Mbps in the same switch and automatically distinguishes the speed of incoming connection.

This section describes the hardware features of FSD-808HP. For easier management and control of the Switch, familiarize yourself with its display indicators, and ports. Front panel illustrations in this chapter display the unit LED indicators. Before connecting any network device to the FSD-808HP, please read this chapter carefully.

2.1 Front Panel

The Front Panel of the FSD-808HP PoE Ethernet Switch consists of 8x Auto-Sensing 10/100Mbps Ethernet RJ-45 Ports. The LED Indicators are also located on the front panel of the FSD-808HP.

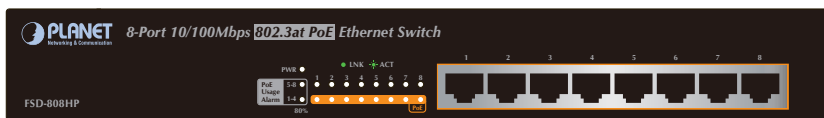

Figure 2-1: FSD-808HP Switch Front Panel

2.1.1 LED Indicators

System

LED	Color	Function
PWR	Green	Light: Indicate the Switch has power.

Per 10/100Mbps Port

LED	Color	Function
PoE	Green	Light: Indicate the port is providing 52V DC in-line power.
LNK/ACT	Green	Light: Indicate the link through that port is successfully established. Blink: Indicate that the Switch is actively sending or receiving data over that port.

PoE Usage Alarm Port

LED	Color	Function
1-4	Orange	Light: Indicate the PoE Usage is over 80% Blink: Indicate the PoE Usage is 100%
5-8	Orange	Light: Indicate the PoE Usage is over 80% Blink: Indicate the PoE Usage is 100%

2.2 Rear Panel

The rear panel of the FSD-808HP indicates an AC inlet power socket, which accepts input power from 100 to 240V AC, 50-60Hz.

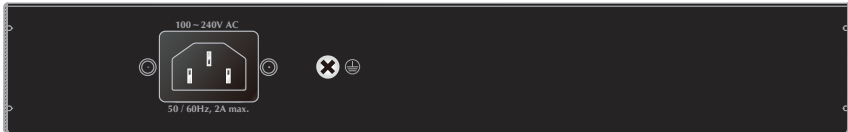

Figure 2-2: FSD-808HP Switch Rear Panel



Power Notice

1. The device is a power-required device, it means, it will not work till it is powered. If your networks should active all the time, please consider using UPS (Uninterrupted Power Supply) for your device. It will prevent you from network data loss or network downtime.
2. In some area, installing a surge suppression device may also help to protect your FSD-808HP from being damaged by unregulated surge or current to the FSD-808HP or the power adapter.

3. Hardware Installation

Start up

Please refer to the followings for your cabling:

10/100Base-TX

All 10/100Base-TX ports come with Auto-Negotiation capability. They automatically support 100Base-TX and 10Base-T networks. Users only need to plug a working network device into one of the 10/100Base-TX ports, and then turn on the FSD-808HP. The port will automatically runs in 10Mbps, 20Mbps, 100Mbps or 200Mbps after the negotiation with the connected device.

Cabling

Each 10/100Base-TX ports use RJ-45 sockets -- similar to phone jacks -- for connection of unshielded twisted-pair cable (UTP). The IEEE 802.3 / 802.3u Fast Ethernet standard requires Category 5, 5e UTP for 100Mbps 100Base-TX. 10Base-T networks can use Cat. 3, 4, 5 (see table below). Maximum distance is 100meters (328 feet).

Port Type	Cable Type	Connector
10Base-T	Cat. 3, 4, 5, 2-pair	RJ-45
100Base-TX	Cat. 5, 5e UTP, 4-pair	RJ-45

Any Ethernet devices like hubs/PCs can connect to the FSD-808HP by using straight-through wires. The eight-10/100Mbps ports are auto-MDI/MDI-X can be used on straight-through or crossover cable.

3.1 Desktop Installation

To install the Switch on desktop, simply follow the next steps:

Step1: Attach the rubber feet to the recessed areas on the bottom of the Switch, as shown in Figure 3-1.

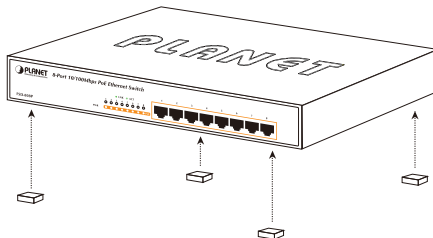

Figure 3-1: Attaching the Rubber Feet to the PoE Fast Ethernet Switch

Step2: Place the Switch on desktop near an AC power source.

Step3: Keep enough ventilation space between the Switch and the surrounding objects.



Note

When choosing a location, please keep in mind the environmental restrictions discussed in Chapter 1, Section 4, in Specification.

Step4: Connect your Switch to 802.3af / 802.3at complied Power Devices (PD) and other network devices.

- A.** Connect one end of a standard network cable to the 10/100 RJ-45 ports at front panel of the Switch.
- B.** Connect the other end of the cable to the network devices such as printer servers, workstations or routers...etc.



Note

Connection to the Switch requires UTP Category 5, 5e, 6 network cabling with RJ-45 tips. For more information, please see the Cabling Specification in Appendix A.

Step5: Supply power to the Switch.

- A.** Connect one end of the power cable to the Switch.
- B.** Connect the power plug of the power cable to a standard wall outlet.

When the Switch receives power, the Power LED should remain solid Green.

3.2 Rack Mounting

To install the Switch in a 19-inch standard rack, follow the instructions described below.

Step1: Place your POE Fast Ethernet Switch on a hard flat surface, with the front panel positioned towards your front side.

Step2: Attach a rack-mount bracket to each side of the Switch with supplied screws attached to the package. Figure 3-2 shows how to attach brackets to one side of the Switch.

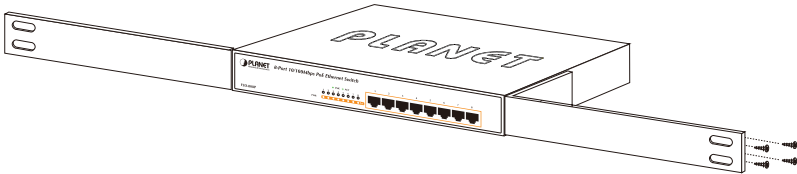

Figure 3-2: Attaching the Brackets to the Switch.



You must use the screws supplied with the mounting brackets. Damage caused to the parts by using incorrect screws would invalidate the warranty.

Step3: Secure the brackets tightly.

Step4: Follow the same steps to attach the second bracket to the opposite side.

Step5: After the brackets are attached to the Switch, use suitable screws to securely attach the brackets to the rack, as shown in Figure 3-3.

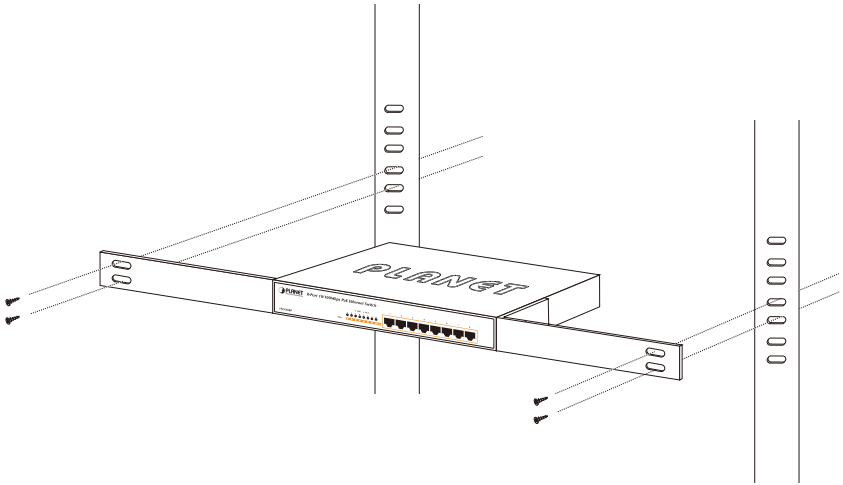

Figure 3-3: Mounting the Switch in a Rack

Step6: Proceeds with the steps 4 and steps 5 of session 3.1 Desktop Installation to connect the network cabling and supply power to your Switch.

3.3 Product Application

3.3.1 Supports IEEE 802.3af and IEEE 802.3at Standard

FSD-808HP is an ideal solution for **IEEE 802.3af** and **High Power IEEE 802.3at** Power over Ethernet (PoE) application. It combines up to **140 Watts** power output budget and data transfer over one Cat. 5E / 6 Ethernet cable. With totally 140 Watts PoE budget on whole system, it is designed specifically to satisfy the growing demand of higher power consuming network PD (powered devices) such as PTZ (Pan, Tilt & Zoom) / Speed Dome network cameras, multi- channel (802.11a / b / g / n) wireless LAN access points and other network devices by providing double PoE power than conventional 802.3af PoE currently.

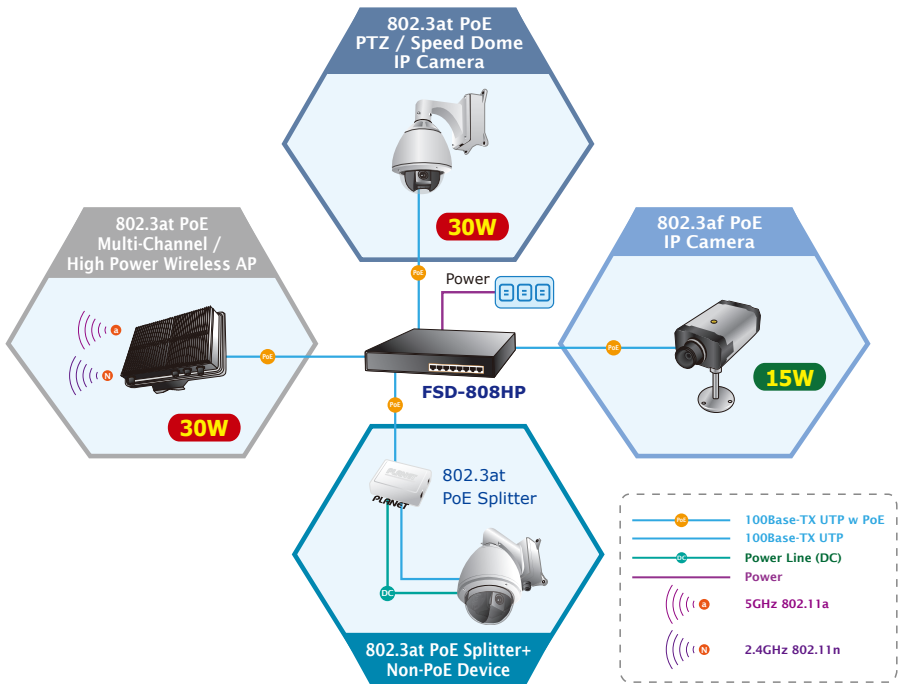

Figure 3-4: Kind of IEEE 802.3af and IEEE 802.3at devices



Cable distance for Switch

The cable distance between the FSD-808HP and PC should not exceed 100 meter for UTP/STP cable.

Make sure the wiring is correct

It can be used Category 3/4/5 cable in 10 Mbps operation. To reliably operate your network at 100Mbps, you must use an Unshielded Twisted-Pair (UTP) Category 5/5e cable, or better Data Grade cabling. While a Category 3 or 4 cables may initially seem to work, it will soon cause data loss.

3.3.2 IP Office Department / Workgroup PoE Switch

As the business expands, the additional telephones required could be installed in less cost via the implementation of PoE IP Telephony system than that of the traditional circuit wiring telephony system. PLANET FSD-808HP PoE Switch helps enterprises to efficiently create an integrated data, voice, and powered VoIP network. PLANET IEEE 802.3af compliant IP Phones can be installed without any power cable because it can be powered via the standard Ethernet cable from the connected FSD-808HP. With the FSD-808HP, IP Telephony deployment becomes more reliable and cost effective, which helps enterprises save tremendous cost when upgrading from the traditional telephony system to IP Telephony communications infrastructure.

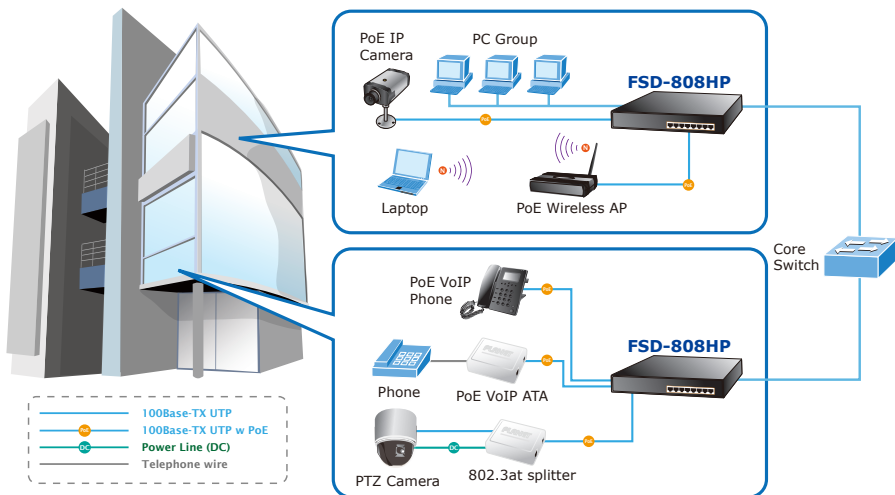







Figure 3-5: IP Office Department / Workgroup PoE Switch Connection

3.4 Power over Ethernet Powered Device

 <p>3~5 Watts</p>	<p>Voice over IP phones Enterprise can install POE VoIP Phone, ATA and other Ethernet/non-Ethernet end-devices to the central where UPS is installed for un-interrupt power system and power control system.</p>
 <p>6~12 Watts</p>	<p>Wireless LAN Access Points Museum, Sightseeing, Airport, Hotel, Campus, Factory, Warehouse can install the Access Point any where with no hesitation.</p>
 <p>10~12 Watts</p>	<p>IP Surveillance Enterprise, Museum, Campus, Hospital, Bank, can install IP Camera without limits of install location – no need electrician to install AC sockets.</p>
 <p>3~12 Watts</p>	<p>PoE Splitter PoE Splitter split the PoE 48V DC over the Ethernet cable into 5/12V DC power output. It frees the device deployment from restrictions due to power outlet locations, which eliminate the costs for additional AC wiring and reduces the installation time.</p>
 <p>30 Watts</p>	<p>High Power Speed Dome This state-of-the-art design is considerable to fit in various network environments like traffic centers, shopping malls, railway stations, warehouses, airports, and production facilities for the most demanding outdoor surveillance applications- no need electrician to install AC sockets.</p>



Note

Since the FSD-808HP per PoE port supports 52V DC PoE power output, please check and assure the Powered Device (PD) acceptable DC power range is from 52V DC. Otherwise, it will damage the Powered Device (PD).

4. Power Over Ethernet Overview

What is PoE?

The PoE is an abbreviation of Power over Ethernet; the PoE technology means a system to pass electrical power safely, along with data on Ethernet UTP cable. The IEEE standard for PoE technology requires Category 5 cable or higher for high power PoE levels, but can operate with category 3 cable for low power levels. Power is supplied in common mode over two or more of the differential pairs of wires found in the Ethernet cables and comes from a power supply within a PoE-enabled networking device such as an Ethernet switch or can be injected into a cable run with a mid-span power supply.

The original IEEE 802.3af-2003 PoE standard provides up to 15.4 W of DC power (minimum 44V DC and 350mA) to each device. Only 12.95 W is assured to be available at the powered device as some power is dissipated in the cable.

The updated IEEE 802.3at-2009 PoE standard also known as PoE+ or PoE plus, provides up to 25.5 W of power. The 2009 standard prohibits a powered device from using all four pairs for power

The 802.3af / 802.3at define two types of source equipment: Mid-Span and End-Span.

Mid-Span

Mid-Span device is placed between legacy switch and the powered device. Mid-Span is tap the unused wire pairs 4/5 and 7/8 to carry power, the other four is for data transmit.

End-Span

End-Span device is direct connecting with power device. End-Span could also tap the wire 1/2 and 3/6.

PoE System Architecture

The specification of PoE typically requires two devices: the **Powered Source Equipment (PSE)** and the **Powered Device (PD)**. The PSE is either an End-Span or a Mid-Span, while the PD is a PoE-enabled terminal, such as IP Phones, Wireless LAN, etc. Power can be delivered over data pairs or spare pairs of standard CAT-5 cabling.

Powered Source Equipment (PSE)

Power sourcing equipment (PSE) is a device such as a switch that provides (sources) power on the Ethernet cable. The maximum allowed continuous output power per cable in IEEE 802.3af is 15.40 W. A later specification, IEEE 802.3at,

offers 25.50 W. When the device is a switch, it is commonly called an End-span (although IEEE 802.3af refers to it as endpoint). Otherwise, if it's an intermediary device between a non PoE capable switch and a PoE device, it's called a Mid-span. An external PoE injector is a Mid-span device.

Powered device

A powered device (PD) is a device powered by a PSE and thus consumes energy. Examples include wireless access points, IP Phones, and IP cameras. Many powered devices have an auxiliary power connector for an optional, external, power supply. Depending on the PD design, some, none, or all power can be supplied from the auxiliary port, with the auxiliary port sometimes acting as backup power in case of PoE supplied power failure.

How Power is Transferred Through the Cable

A standard CAT5 Ethernet cable has four twisted pairs, but only two of these are used for 10BASE-T and 100BASE-TX. The specification allows two options for using these cables for power, shown in Figure 1 and Figure 2:

The spare pairs are used. Figure 1 shows the pair on pins 4 and 5 connected together and forming the positive supply, and the pair on pins 7 and 8 connected together and forming the negative supply. (In fact, a late change to the spec allows either polarity to be used).

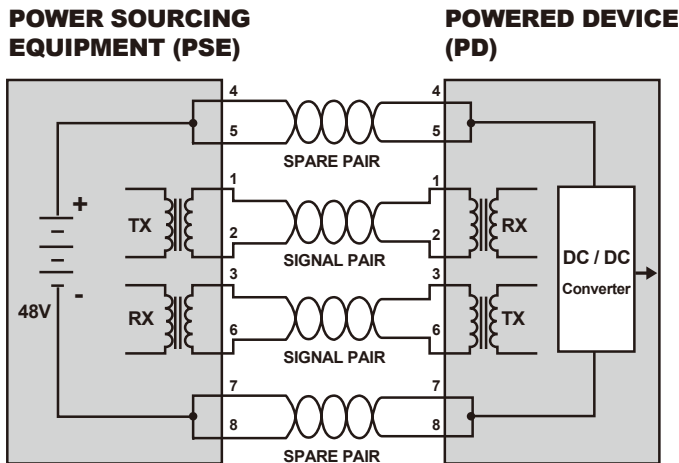

Figure 1: Power Supplied over the Spare Pins

The data pairs are used. Since Ethernet pairs are transformer coupled at each end, it is possible to apply DC power to the center tap of the isolation transformer without upsetting the data transfer. In this mode of operation the pair on pins 3 and 6 and the pair on pins 1 and 2 can be of either polarity.

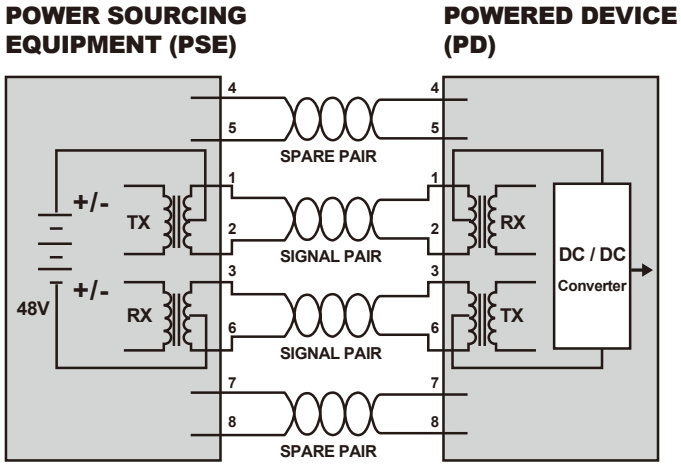

Figure 2: Power Supplied over the Data Pins

5. Troubleshooting

This chapter contains information to help you solve problems. If the Switch is not functioning properly, make sure the Ethernet Switch was set up according to instructions in this manual.

The Link LED is not light

Solution:

Check the cable connection and remove duplex mode of the Switch.

Performance is bad

Solution:

Check the full duplex status of the Switch. If the Ethernet Switch is set to full duplex and the partner is set to half duplex, then the performance will be poor.

100Base-TX port link LED is light, but the traffic is irregular

Solution:

Check that the attached device is not set to dedicate full duplex. Some devices use a physical or software switch to change duplex modes. Auto-negotiation may not recognize this type of full-duplex setting.

Why the Switch doesn't connect to the network

Solution:

Check the LNK/ACT LED on the switch Try another port on the Switch Make sure the cable is installed properly Make sure the cable is the right type Turn off the power. After a while, turn on power again.

Why connects PoE device to FSD-808HP and it cannot power on?

Solution:

Please check the cable type of the connection from FSD-808HP (port 1 to port 8) to the other end. The cable should be an 8-wire UTP, Category 5 or above, EIA568 cable within 100 meters. A cable with only 4-wire, short loop or over 100 meters, all will affect the power supply.

Please check and assure the device that fully complied with IEEE 802.3af / IEEE 802.3at standard.

What is the power output of each PoE port?

Solution:

1. Each PoE port supports 52V DC, 535mA, max 30 Watts power output. Detect and inject by the standard of IEEE 802.3at.
2. Each PoE port supports 52V DC, 275mA, max 15.4 Watts power output. Detect and inject by the standard of IEEE 802.3af.

Appendix A Networking Connection

A.1 PoE Switch RJ-45 Port Pin Assignments

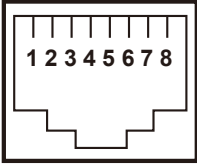
	PIN NO	RJ-45 SIGNAL ASSIGNMENT
	1	● Negative Power +
	2	● Negative Power +
	3	● Positive Power -
	6	● Positive Power -

A.2 10/100Mbps, 10/100Base-TX

When connecting Switch to another Fast Ethernet switch, a straight or crossover cable might necessary. Each port of the Switch supports auto-MDI/MDI-X detection. That means you can directly connect the Switch to any Ethernet devices without making a crossover cable. The following table and diagram show the standard RJ-45 receptacle/connector and their pin assignments:

RJ-45 Connector pin assignment		
Contact	MDI Media Dependant Interface	MDI-X Media Dependant Interface- Cross
1	Tx + (transmit)	Rx + (receive)
2	Tx - (transmit)	Rx - (receive)
3	Rx + (receive)	Tx + (transmit)
4, 5	Not used	
6	Rx - (receive)	Tx - (transmit)
7, 8	Not used	

The standard cable, RJ-45 pin assignment

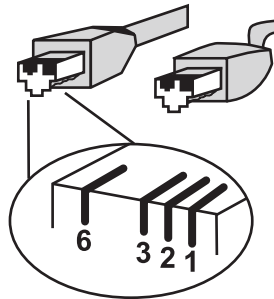

The standard RJ-45 receptacle/connector

There are 8 wires on a standard UTP/STP cable and each wire is color-coded. The following shows the pin allocation and color of straight cable and crossover cable connection:

Straight Cable		<u>SIDE 1</u>	<u>SIDE 2</u>
	SIDE 1	1 = White/Orange	1 = White/Orange
	SIDE 2	2 = Orange	2 = Orange
	SIDE 1	3 = White/Green	3 = White/Green
	SIDE 2	4 = Blue	4 = Blue
	SIDE 1	5 = White/Blue	5 = White/Blue
	SIDE 2	6 = Green	6 = Green
	SIDE 1	7 = White/Brown	7 = White/Brown
	SIDE 2	8 = Brown	8 = Brown

Crossover Cable		<u>SIDE 1</u>	<u>SIDE 2</u>
	SIDE 1	1 = White/Orange	1 = White/Green
	SIDE 2	2 = Orange	2 = Green
SIDE 1	3 = White/Green	3 = White/Orange	
SIDE 2	4 = Blue	4 = Blue	
SIDE 1	5 = White/Blue	5 = White/Blue	
SIDE 2	6 = Green	6 = Orange	
SIDE 1	7 = White/Brown	7 = White/Brown	
SIDE 2	8 = Brown	8 = Brown	

Figure A-1: Straight-Through and Crossover Cable

Please make sure your connected cables are with same pin assignment and color as above picture before deploying the cables into your network.

EC Declaration of Conformity

For the following equipment:

*Type of Product : 8-Port 10/100Mbps 802.3at PoE Desktop Switch (150 Watts)
*Model Number : FSD-808HP
* Produced by:
Manufacturer's Name : **Planet Technology Corp.**
Manufacturer's Address : 10F., No.96, Minquan Rd., Xindian Dist.,
New Taipei City 231, Taiwan (R.O.C.).

is herewith confirmed to comply with the requirements set out in the Council Directive on the Approximation of the Laws of the Member States relating to Electromagnetic Compatibility Directive on (2004/108/EC).

For the evaluation regarding the EMC, the following standards were applied:

EN 55022	(Class B : 2006 + A1:2007)
EN 55024	(1998+A1:2001+A2:2003)
IEC 61000-4-2	(2008)
IEC 61000-4-3	(2008)
IEC 61000-4-4	(2004)
IEC 61000-4-5	(2005)
IEC 61000-4-6	(2008)
IEC 61000-4-11	(2004)
EN 60950-1	(2006 + A11:2009 + A1:2010)

Responsible for marking this declaration if the:

Manufacturer Authorized representative established within the EU

Authorized representative established within the EU (if applicable):

Company Name: Planet Technology Corp.

Company Address: 10F., No.96, Minquan Rd., Xindian Dist., New Taipei City 231, Taiwan (R.O.C.)

Person responsible for making this declaration

Name, Surname Kent Kang

Position / Title : Product Manager

Taiwan
Place

31. Dec., 2012
Date

Legal Signature

PLANET TECHNOLOGY CORPORATION

This page is intentionally left blank