

INSTRUCTION MANUAL

Vibration Meter

VM-82A



3-20-41 Higashimotomachi, Kokubunji, Tokyo 185-8533, Japan

<http://www.rion.co.jp/english/>

Organization of This Manual

This manual describes the features and operation of the Vibration Meter VM-82A. If the unit is used together with other equipment to configure a measurement system, consult the documentation of all other components as well. The section starting on page iii contains important information and precautions about safety. Be sure to read and observe these in full.

The manual contains the following sections.

Outline

Gives basic information on the configuration and features of the unit, and contains a block diagram.

Controls and features

Briefly identifies and explains all parts of the unit.

Display explanation

Explains the LCD display located on the front panel of the unit.

Preparations

Describes how to insert batteries, connect cables, and mount the piezoelectric accelerometer.

Setup

Describes how to set the time and the sensitivity.

Measurement

Describes the basic steps for measurement.

Reference

Provides information about filter frequency response characteristics.

Use of optional accessories

Explains how to connect the optional AC adapter and printer, and how to connect the unit to a computer.

Specifications

Lists the technical specifications of the unit.

- * All company names and product names mentioned in this manual are usually trademarks or registered trademarks of their respective owners.

This product can be used in any areas including residential areas.

To conform to the EU requirement of the Directive on Waste Electrical and Electronic Equipment, the symbol mark on the right is shown on the instrument.



FOR SAFETY

In this manual, important safety instructions are specially marked as shown below. To prevent the risk of death or injury to persons and severe damage to the unit or peripheral equipment, make sure that all instructions are fully understood and observed.

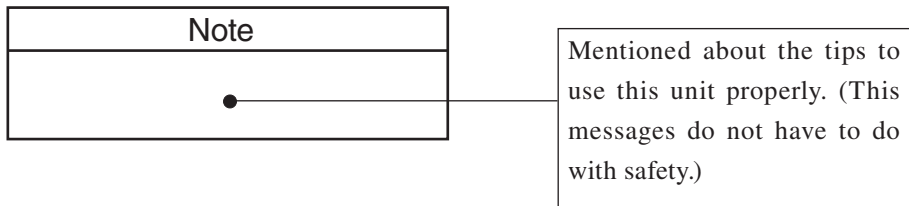
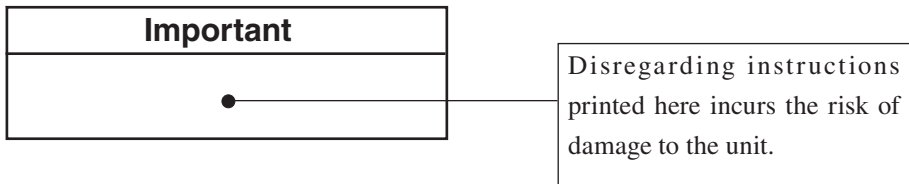
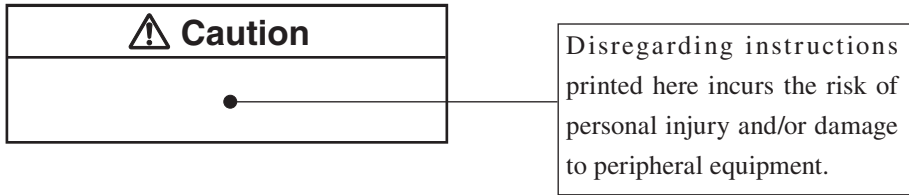

Precautions

- Operate the unit only as described in this manual.
- Take care not to drop the unit, and protect it from shocks and vibrations.
- Do not store or use the unit in locations where the unit may be subject to
 - splashes of water or high levels of dust,
 - air with high salt or sulphur content, or other gases or chemicals,
 - high temperature (50°C or more), high humidity (90%RH or more), or direct sunlight,
 - directly transmitted vibrations or shock.
- Observe the following precautions after using the unit:
 - Always turn the unit to off.
 - When the unit is not to be used for a week or longer, remove the batteries to prevent possible damage caused by battery leakage.
- Do not disassemble the unit or attempt internal alterations.
- Have the unit and the piezoelectric accelerometer checked and serviced about once every 18 to 24 months. (Sensitivity calibration can be performed at the factory for a fee.)
- When powering the unit externally, use only the specified optional AC adapter (NC-98C). Using a different adapter may cause malfunction or damage.
- Do not tap the LCD panel for example with your finger or a pen, to prevent possible malfunction or damage.
- The life of the backup battery for the internal clock of the unit is limited. You should have the battery replaced about once every five years. Regarding replacement of the battery, please contact your supplier.
- In case of malfunction, do not attempt any repairs. Note the condition of the unit clearly and contact the supplier.

- When using the unit near rotating machinery, take care that cables cannot be caught in the machinery.
- When disposing of the unit or the accessories, follow national and local regulations regarding waste disposal.

环保使用期限标识



该标识用于表示在中国销售的电子信息产品的环保使用期限。只要您遵守该产品在安全和使用等方面的规定，则从制造之日起开始算起的使用年限内，它不会对环境、人体及财产带来严重影响。

有毒有害物质或元素的名称及含量

部件名称	有毒有害物质或元素					
	铅 (Pb)	汞 (Hg)	镉 (Cd)	六价铬 (Cr(VI))	多溴联苯 (PBB)	多溴二苯醚 (PBDE)
VM-82A	×	×	×	×	×	×

○：表示该有毒有害物质在该部件所有均质材料中的含量均在 SJ/T 11363-2006 规定的限量要求以下。

×：表示该有毒有害物质至少在该部件的某一均质材料中的含量超出 SJ/T 11363-2006 规定的限量要求。

(上表中的 × 印记也包含有在本产品制造阶段未经确认的情报。因此，在得到技术验证后，会没有事先通告即变更本表中的含有量。)

이 기기는 가정용(B급) 전자파적합기기로서 주로 가정에서 사용하는 것을 목적으로 하며, 모든 지역에서 사용할 수 있습니다.

Contents

FOR SAFETY.....	iii
Outline.....	1
Controls and features	3
Front panel	3
Right side panel	7
Left side panel	9
Rear panel.....	10
Piezoelectric accelerometer.....	11
Display explanation.....	12
Preparations	15
Power supply.....	15
Cable and accelerometer connection	18
Piezoelectric accelerometer mounting.....	21
Power-up and version indication/unit initialization	26
Setup.....	28
Setting mode.....	28
Measurement.....	31
Vibration measurement	31
Storing measurement data.....	34
Recall mode.....	36
Clearing stored data	37
Output signal recording	38
About the AC output signal	39
About the DC output signal	40
Reference	41
High-pass filter characteristics	41
Low-pass filter characteristics.....	42

Use of optional accessories	43
Use of AC adapter.....	43
Connection to a printer	44
Connection to a computer	48
VM-82A data transfer software	49
Specifications	50

Outline

The VM-82A is designed mainly for routine maintenance and monitoring of rotational and other industrial machinery. It can measure acceleration (ACC), velocity (VEL), and displacement (DISP) using a suitable frequency range to evaluate machine vibrations.

Besides a large numeric readout, a bar graph display that functions like an analog meter makes it easy to observe any changes in measurement value.

The internal memory allows storage of measurement data, for example for later processing on a computer.

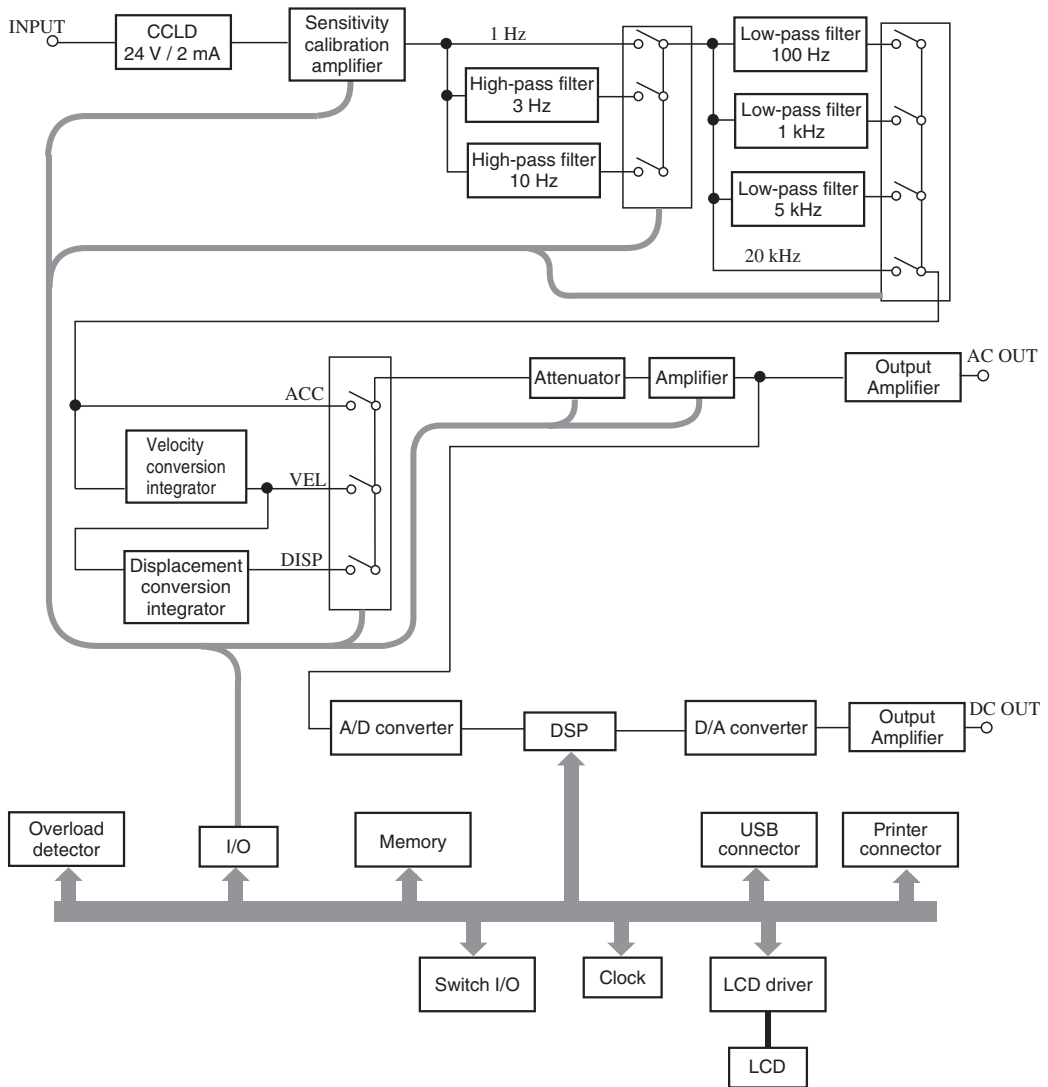

VM-82A block diagram

Controls and features

Front panel

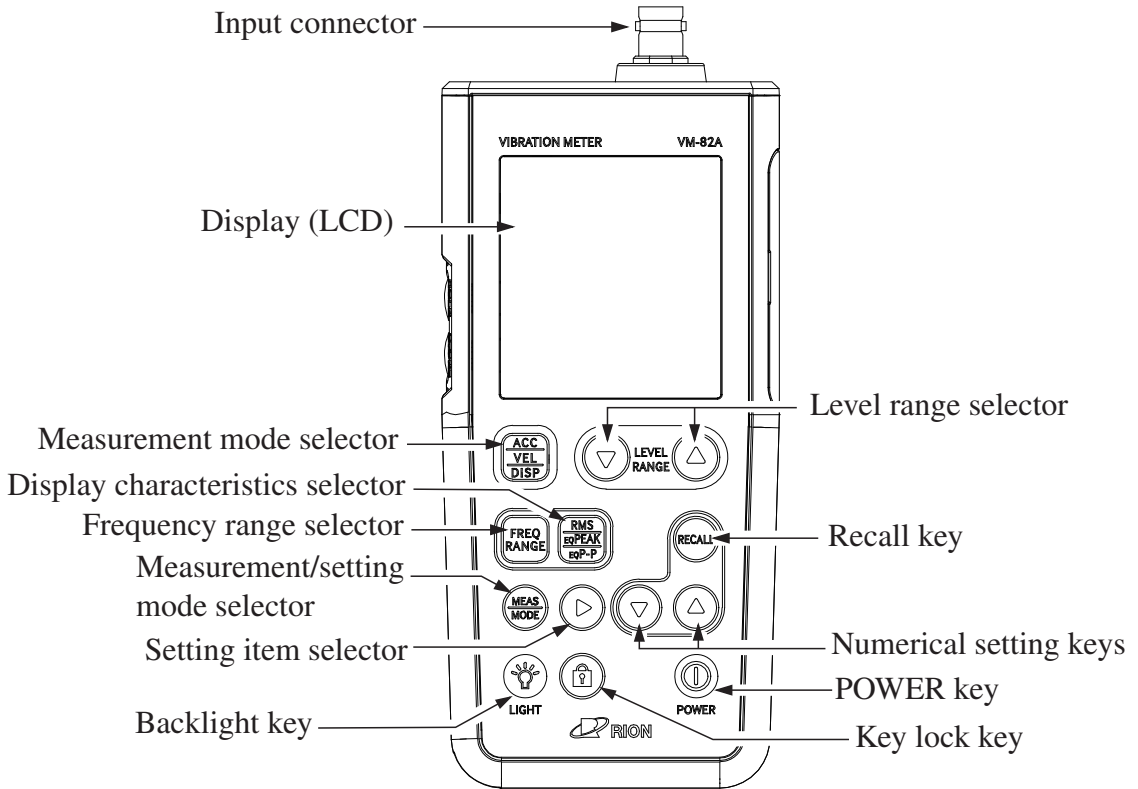

Input connector

The piezoelectric accelerometer PV-57I is to be connected here, using the supplied curled cable. The power supply to drive the accelerometer (24 V, 2 mA) is always output from the input connector.

Display (LCD)

Shows the measurement value and status information (see page 12).

Measurement mode selector (ACC/VEL/DISP)

This key serves to select measurement of acceleration (ACC), velocity (VEL), or displacement (DISP). With each push of the key, the selection changes in the order **ACC (m/s²)** → VEL (mm/s) → DISP (mm) → ACC (m/s²) etc. (shaded settings are the factory defaults).

Display characteristics selector (RMS/EQ PEAK/EQ P-P)

This key serves to set the display characteristics for each measurement mode. Once the setting is made, it will be used every time the measurement mode is selected. The following settings are available (shaded settings are the factory defaults).

ACC: **EQ PEAK**, RMS
VEL: **RMS**, EQ PEAK
DISP: **EQ PEAK**, EQ P-P, RMS

The display characteristics settings have the following meaning.

RMS (effective value) :

The average intensity of the time waveform signal over a certain period is shown. The value is calculated as the square root of the mean (average) value of the squared function of the signal.

EQ PEAK (equivalent peak value):

This is the maximum peak value based on the assumption that the RMS value is for a sinusoidal wave.

It is calculated as $\text{RMS} \times \sqrt{2} = \text{EQ PEAK}$.

EQ P-P (equivalent peak-to-peak value):

This is the difference between the minimum and the maximum peak value based on the assumption that the RMS value is for a sinusoidal wave. It is calculated as $\text{EQ PEAK} \times 2 = \text{EQ P-P}$.

Frequency range selector (FREQ RANGE)

This key serves to select the frequency range for each measurement mode. Once the setting is made, that setting will be used every time the measurement mode is selected. The following settings are available (shaded settings are the factory defaults).

ACC: **3 Hz to 1 kHz**, 3 Hz to 5 kHz, 1 Hz to 100 Hz, 3 Hz to 20 kHz
VEL: **10 Hz to 1 kHz**, 3 Hz to 1 kHz
DISP: **10 Hz to 500 Hz**, 3 Hz to 500 Hz

Measurement/setting mode selector (MEAS/MODE)

Pressing the key once in the measurement mode activates the time setting and accelerometer sensitivity setting mode. Pressing the key again switches back to the measurement screen.

Setting item selector (▶)

During the setup procedure for time etc., this key serves to move among the available items. While a setting item is flashing, pushing the key cycles through the items as follows.

→Year (2015) → Month and day (01-15) → Time (12:34) → Sensitivity (5.1) →

Figures shown in brackets are examples.

In measurement mode, the key cycles through the following display settings.

→ Time (12:56) → Year (2015) → Month and day (01-17) →

Figures shown in brackets are examples.

Backlight key (LIGHT)

Toggles the display backlighting on an off. If the key is not pressed, the backlight will go off automatically after about 30 seconds.

Regardless of the setting of this key, the backlight will come on in red when the OVER condition has occurred.

Key lock key

Holding down this key for at least two seconds locks all the front panel keys except for the orange-colored ones.

To cancel the locked condition, press and hold the key again.

POWER key

Turns power to the unit on and off. The key must be held down for at least 2 seconds to take effect.

Numerical setting keys (▼, ▲)

- Recall mode: The keys serve to select the data address.
Time setting: The keys serve to set the time.
Accelerometer sensitivity: The keys serve to set the sensitivity value.
Measurement mode: The keys serve to select the data address.

Recall key (RECALL)

This key serves to recall stored measurement data. Press the key once to activate the recall mode (indication RECALL is shown on the display). Pressing the key again switches back to measurement mode.

Level range selector (LEVEL, RANGE, ▼, ▲)

These keys serve to set the level range. Pressing the ▲ key switches to the next higher range and pressing the ▼ key to the next lower range.

The available ranges for the various modes are as listed below.

Using the supplied piezoelectric accelerometer PV-57I or another accelerometer with a sensitivity of 1.0 to 9.9 mV/(m/s²) (1.0 to 9.9 pC/(m/s²)*)

- ACC: 1, 10, 100, 1000 m/s²
VEL: 10, 100, 1000 mm/s
DISP: 0.1, 1, 10, 100 mm

When using an accelerometer with a sensitivity of 0.1 to 0.99 mV/(m/s²) (0.1 to 0.99 pC/(m/s²)*).

- ACC: 10, 100, 1000, 10000 m/s²
VEL: 100, 1000, 10000 mm/s
DISP: 1, 10, 100, 1000 mm

When using an accelerometer with a sensitivity of 10 to 99 mV/(m/s²) (10 to 99 pC/(m/s²)*).

- ACC: 0.1, 1, 10, 100 m/s²
VEL: 1, 10, 100 mm/s
DISP: 0.01, 0.1, 1, 10 mm

* The unit is pC/(m/s²) when the charge converter VP-40 is used.

Right side panel

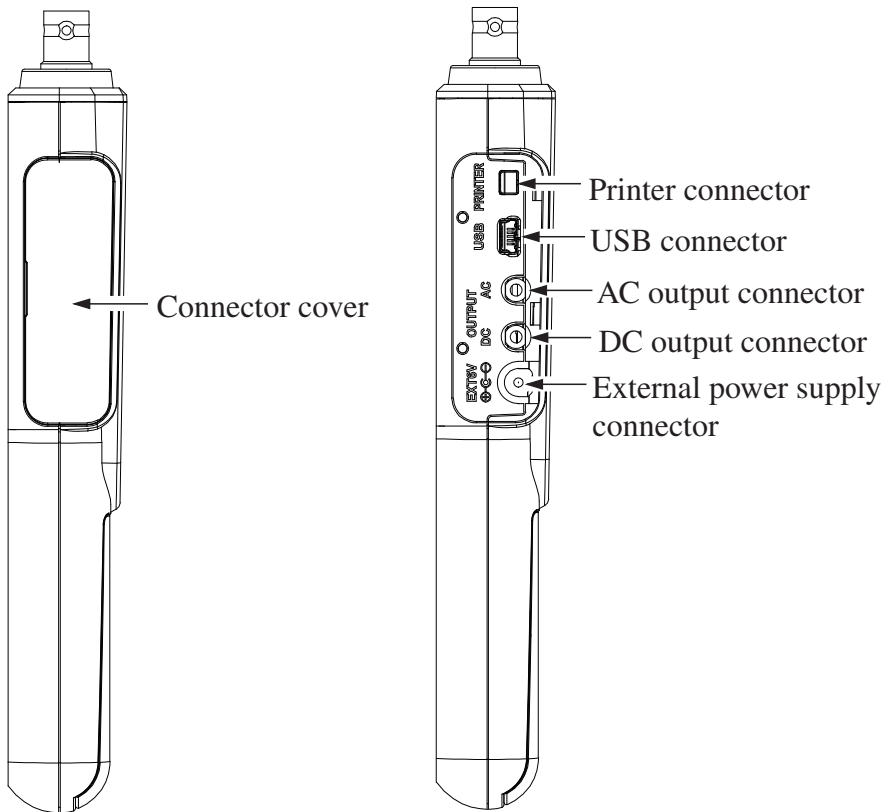

Connector cover

This rubber cover protects the connectors on the right side panel during transport or storage.

Removing the cover gives access to the connectors shown above.

Printer connector

Connect this connector with an input connector of optional printer DPU-414, using the optional printer cable CC-42P.

USB connector

Connect this connector with a USB connector of a computer, using the optional A-miniB USB cable.

AC output connector (OUTPUT AC)

An AC signal corresponding to the measurement value is output here (full-scale value 1 V).

Connect a BNC-mini plug cable CC-24.

DC output connector (OUTPUT DC)

A DC signal corresponding to the measurement value is output here (full-scale value 1 V).

Connect a BNC-mini plug cable CC-24.

External power supply connector (EXT 6V)

The optional AC adapter NC-98C can be connected here to power the unit.

Important
Use only the specified AC adapter. Using a different adapter may cause malfunction or damage.

Left side panel

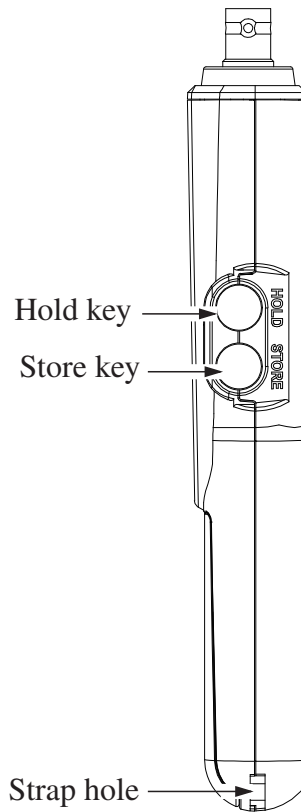

Hold key (HOLD)

Pressing this key freezes the display with the current data. Pressing the key again cancels the hold mode.

Store key (STORE)

Serves to store the currently displayed data in memory.

Strap hole

Use this hole to install the optional carrying strap.

Rear panel

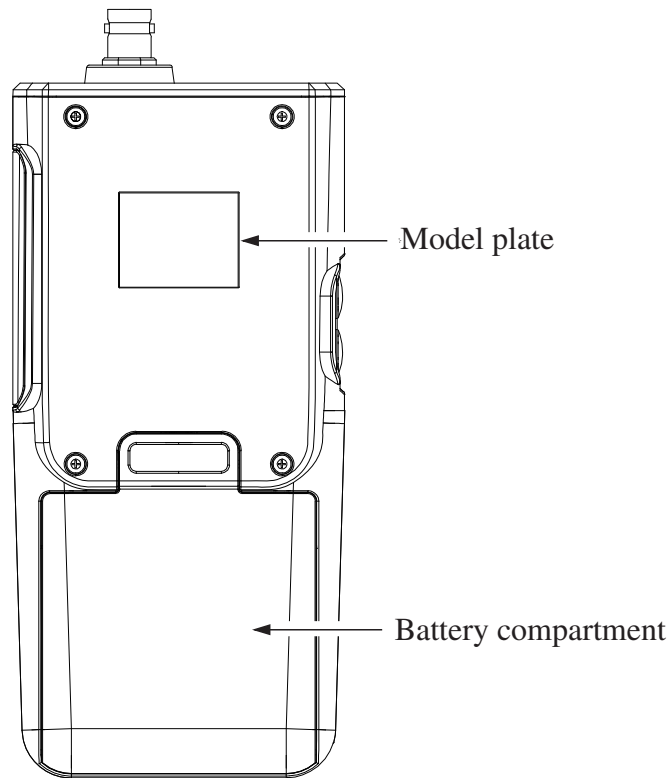

Model plate

Shows information about the model name, type, serial number etc.

Battery compartment

Four batteries (IEC R6, size AA) are inserted here.

Piezoelectric accelerometer

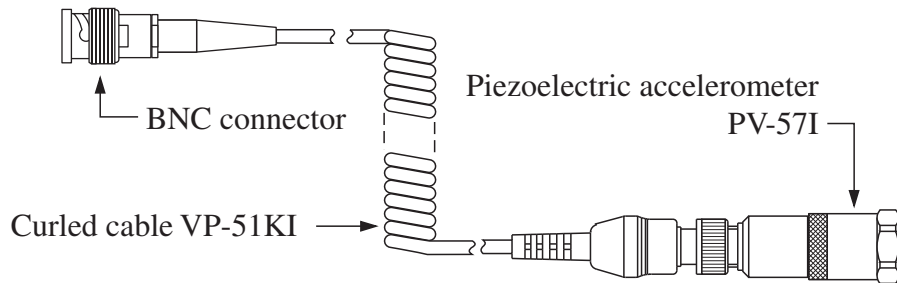

BNC connector

Insert this connector into the input connector on the VM-82A.

Piezoelectric accelerometer PV-57I

Detects vibrations and converts them into an electrical signal. The accelerometer must be coupled to the measurement object using screw mounting or another method (see pages 21 to 25).

Display explanation

For explanation purposes, the illustration below shows all display elements. In actual use, not all elements will be seen together.

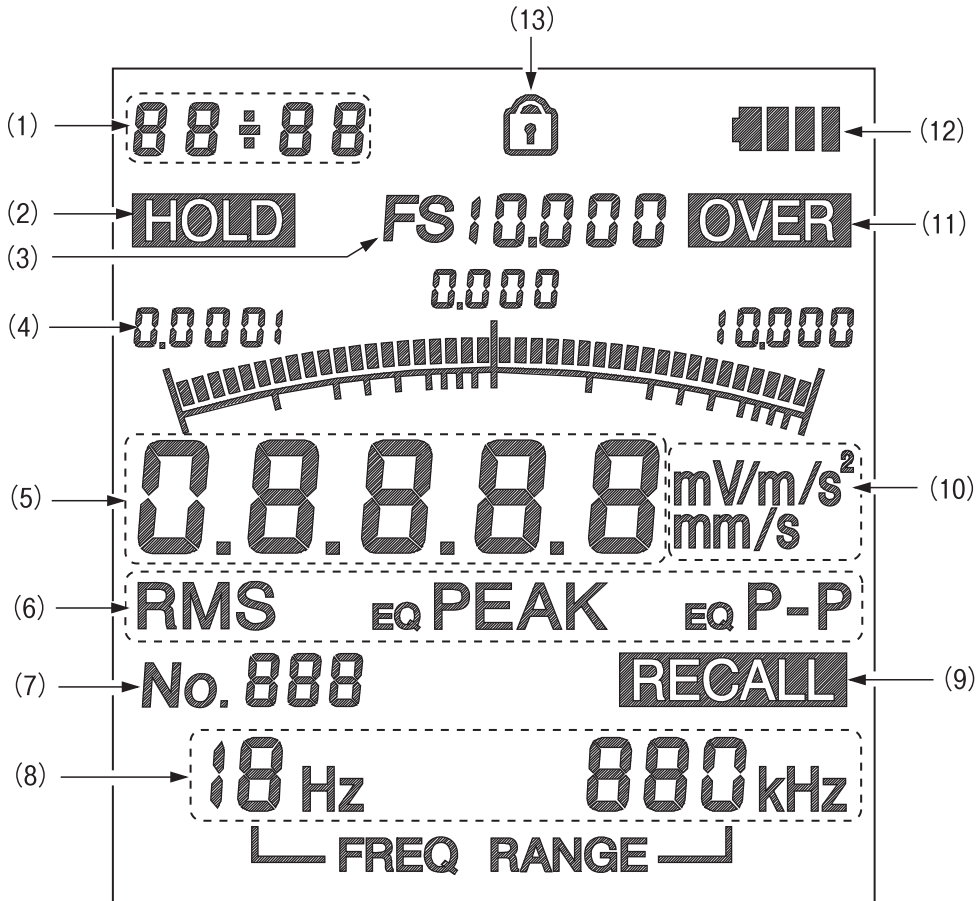

(1) Date/time

Shows the year, month/day, or clock time.

Display example Year: 20 15
 Month/day: 01-15
 Time: 12:34

(2) HOLD

When the hold key was pressed, this indication appears.

(3) Full-scale value

Shows the full-scale value of the current range. The maximum value is 10000. The minimum value is 0.01.

(4) Bar graph display

This graphic display uses logarithmic compression, to achieve an effective range of 40 dB (hundredfold range in display value equivalent). The scale value which agrees with the selected range is displayed.

(5) Measurement value

Numeric indication of measurement value. Display resolution is 001 to 128, and maximum value is 12800.

(6) Display characteristics

Effective value:	RMS
Equivalent peak value:	EQ PEAK
Equivalent peak-to-peak value:	EQ P-P

(7) Store data address

Display range:	No. 000 to 999
----------------	----------------

(8) Frequency range

Left (lower limit)	Right (upper limit)
1 Hz	100 Hz
3 Hz	500 Hz
10 Hz	1 kHz
	5 kHz
	20 kHz

(9) RECALL indicator

When the recall mode is being used, the indication “RECALL” is shown on the display.

(10) Unit for numeric readout

Acceleration (ACC):	m/s ²
Velocity (VEL):	mm/s
Displacement (DISP):	mm
Accelerometer sensitivity:	mV/(m/s ²)

(11) OVER indicator

If an overload condition has occurred during measurement, the indication “OVER” is shown on the display, and the backlight comes on in red.

(12) Battery status indicator

Four-segment indicator shows the remaining battery capacity. When the indication starts to flash, correct measurement is no longer possible. Replace the batteries as described on page 15.

(13) Key lock

When the key lock function has set to ON, this indication appears.

Preparations

This section describes the steps that must be completed before starting a measurement. Always set the power to OFF before inserting batteries and making any connections.

Power supply

This unit can be powered by four IEC R6 (size AA) batteries or by the optional AC adapter NC-98C.

NC-98C: For 100 to 240 V AC

Inserting the batteries

Insert four IEC R6 (size AA) batteries with correct polarity, as shown in the illustration right.

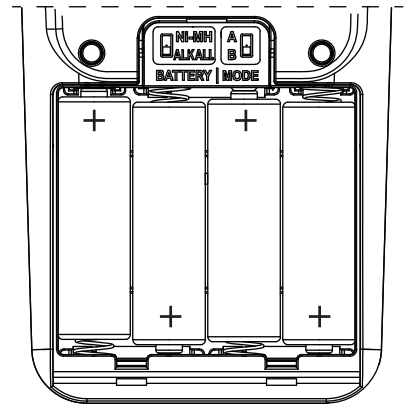

Selecting the battery type

Opening the battery compartment gives access to the battery type selecting switch (BATTERY) as shown below. Select the battery type used for the unit. The remaining battery capacity corresponding to the selected battery type is displayed. Available settings are ALKALI. (alkaline battery) and Ni-MH (nickel-metal hydride battery).

When using nickel-metal
hydride batteries.

When using alkaline
batteries.



Important

Select the correct battery type.

A manganese battery cannot be used.

The life of the batteries depends on various usage factors. For reference, some general figures are given below.

Room temperature, backlight off, communication off, continuous use and connected accelerometer is under quiet conditions.

Alkaline batteries (LR6): approx. 30 hours

Nickel-metal hydride batteries (HR6)

eneloop XX: approx. 32 hours

- * Eneloop XX is trademarks or registered trademarks of the Panasonic Group.
- * Be sure to use a dedicated charger when charging eneloop XX.

When backlight is on, power consumption increases by a factor of about 1.5.

When communication cable is connected, power consumption increases by a factor of about 1.2.

Important
Take care not to insert the batteries with wrong polarity. Make sure that all four batteries are of the same type. Do not mix different battery types or old and new batteries. Remove the batteries from the unit if it is not to be used.

The battery indicator in the top right corner of the display shows the remaining battery capacity.

When using the external power supply connector, the battery remaining capacity is not identified and the battery indicator always shows the state of “Full battery capacity”.

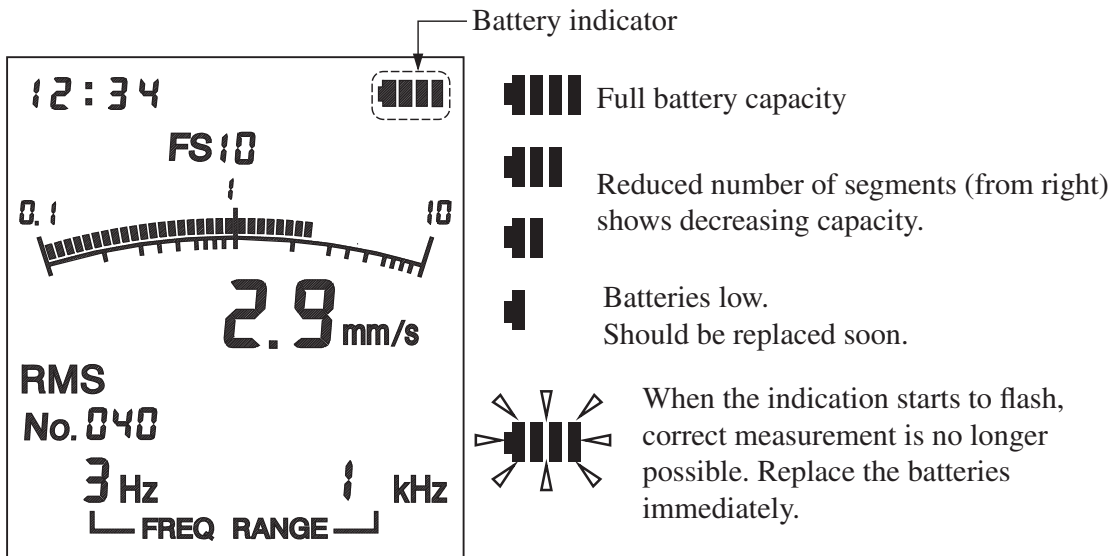

Power-on mode

Opening the battery compartment gives access to the power-on mode switch (MODE) as shown below. Normally the “A” position is used. By setting this switch to “B”, you can have the on/off status of the unit controlled by the power supplied to the external power supply connector (EXT 6V). In such a case, the POWER key on the front panel has no effect.

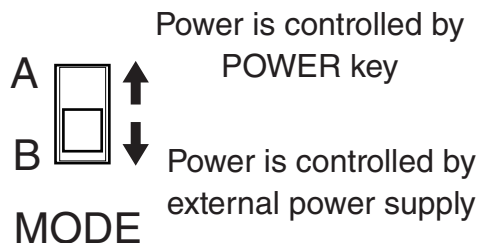

Important

When setting the power-on mode switch to “B”, remove all batteries from the battery compartment. Otherwise the power-on mode will not operate normally.

Remove the batteries from the unit if it is to be stored for a long time with the POWER key set to OFF to prevent possible damage caused by battery leakage.

Cable and accelerometer connection

Important

Make sure that the power of the unit is turned off before connecting or disconnecting the cable and accelerometer.

Note

For extending a connection, use BNC-BNC coaxial cable EC-90 series and BNC relay connector VP-54C.

When using the supplied piezoelectric accelerometer PV-571

Make the connection with the supplied curled cable VP-51KI, as shown in the illustration below.

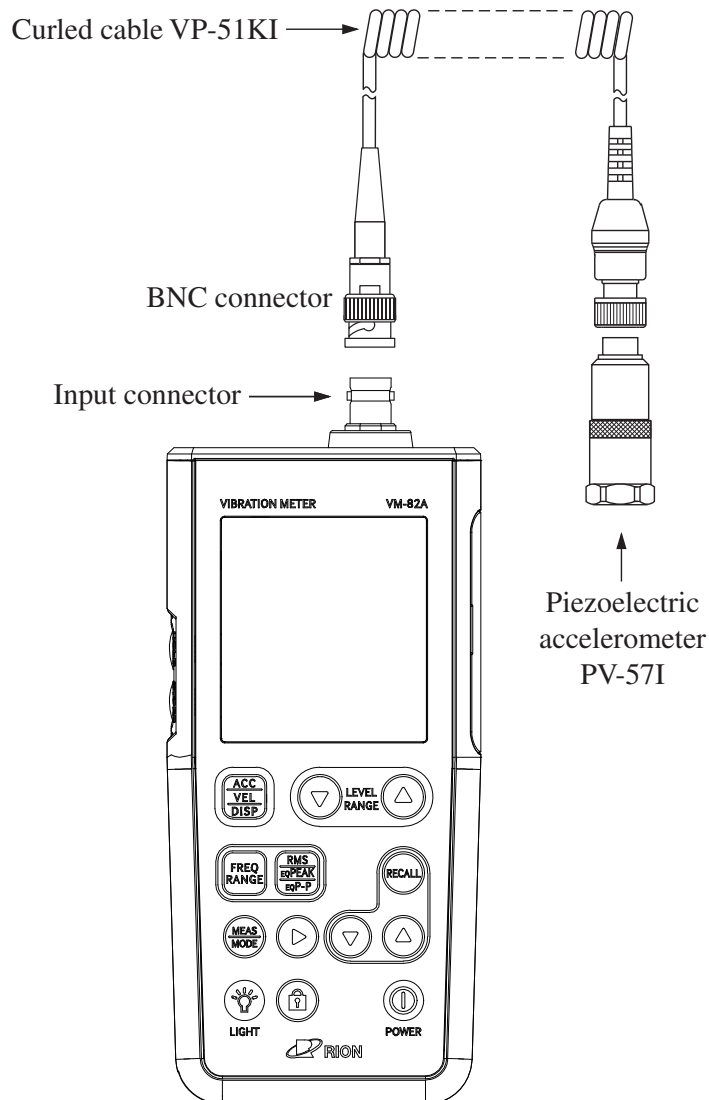

When using a piezoelectric accelerometer with built-in preamplifier

Make the connection with the optional connection cable VP-51 series and BNC adapter VP-52C, as shown in the illustration below.

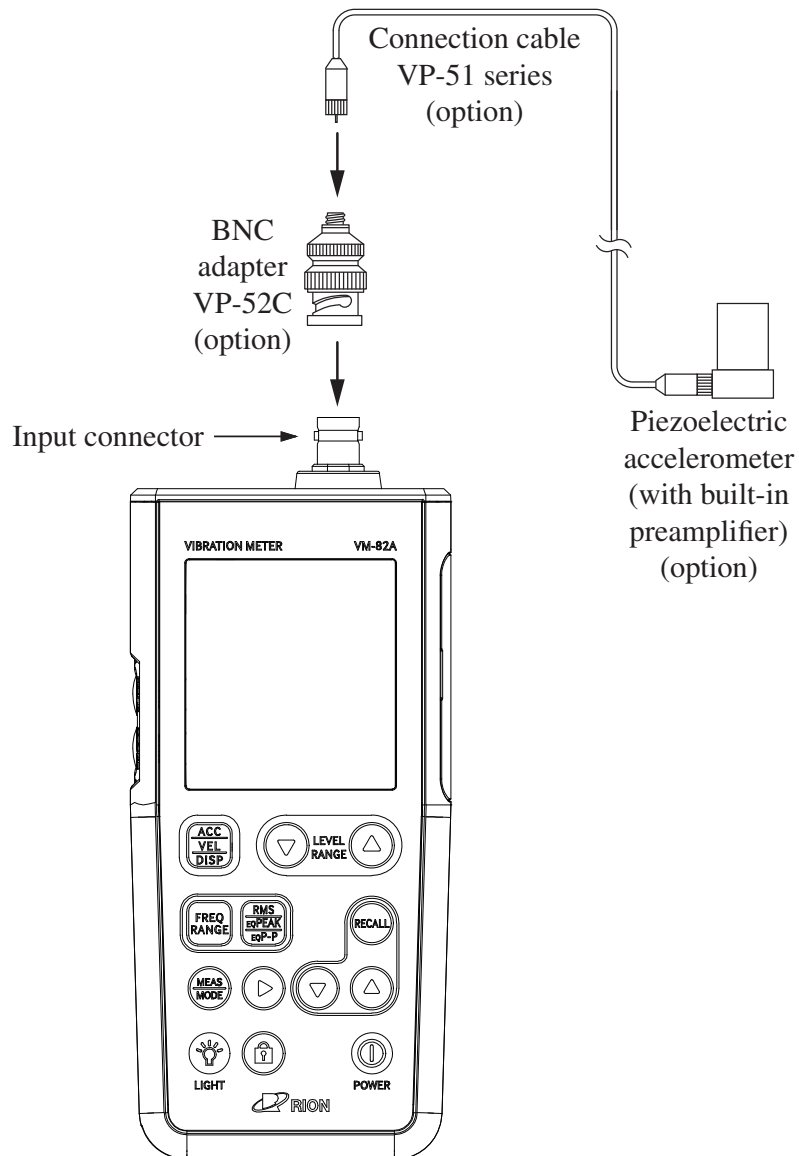

When using a piezoelectric accelerometer without built-in preamplifier

Make the connection with the optional connection cable VP-51 series and charge converter VP-40/VP-42, as shown in the illustration below.

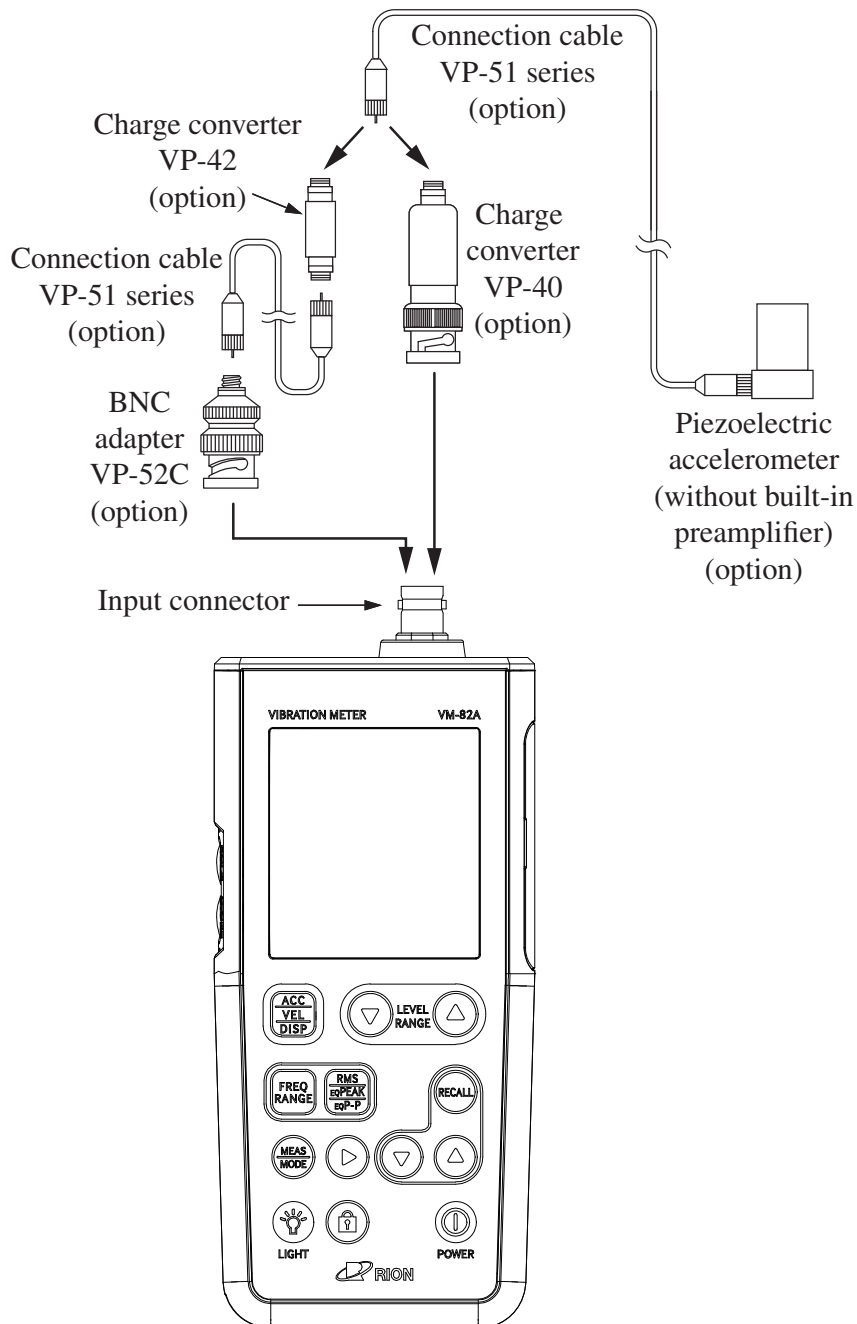

Piezoelectric accelerometer mounting

There are four basic ways of attaching the piezoelectric accelerometer to the measurement object. The piezoelectric accelerometer mounting method greatly affects the contact resonance frequency*. The advantages and disadvantages of the four methods are outlined below, to assist you in choosing the proper method.

*Contact resonance frequency

When the contact area between the piezoelectric accelerometer and the measurement object is partially deformed, a kind of spring system is created which vibrates at a frequency that is determined by the mass of the spring and the piezoelectric accelerometer. This phenomenon is called contact resonance. The contact resonance varies considerably, depending on the piezoelectric accelerometer mounting method. This affects the upper frequency limit of vibrations that can be measured.

The diagram below shows the change in high-frequency characteristics according on the mounting method. To eliminate the effect of contact resonance as much as possible, the mounting method should be chosen so that measurements in the desired frequency range are possible.

When the frequency range is generally less than about 1/3 of a contact resonance frequency, the flat frequency characteristic is obtained.

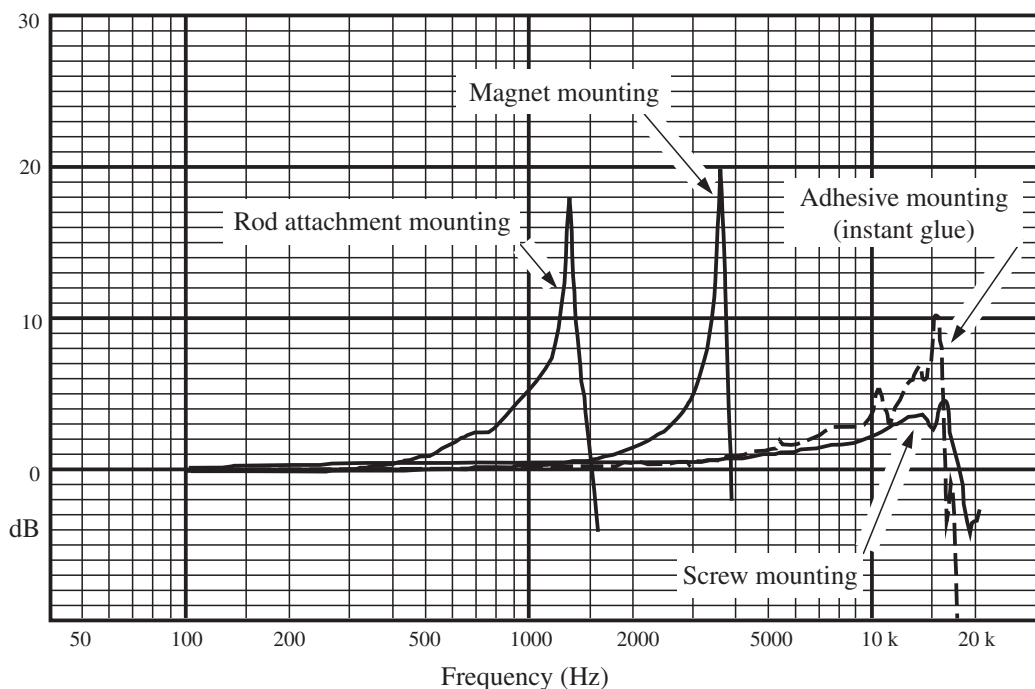

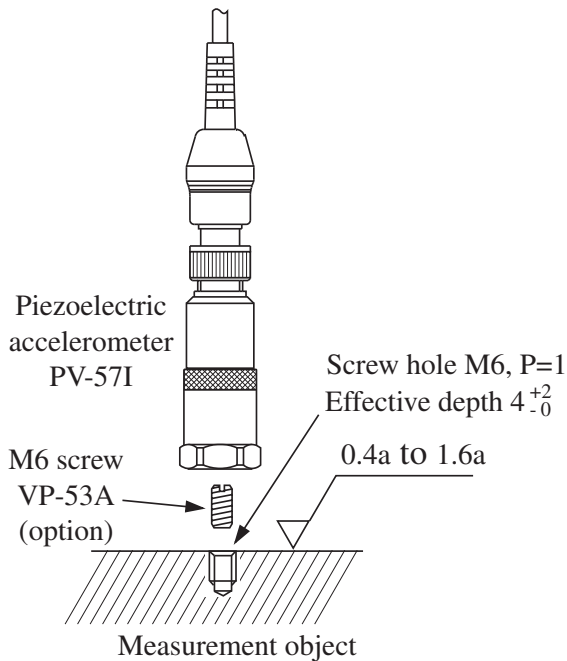

- **Screw mounting**
This method yields the best vibration characteristics. The mounting surface must have a surface smoothness of 0.4a to 1.6a. Use a fastening torque of 1 to 1.5 N·m for the piezoelectric accelerometer and the M6 screw that joins the piezoelectric accelerometer to the measurement object.

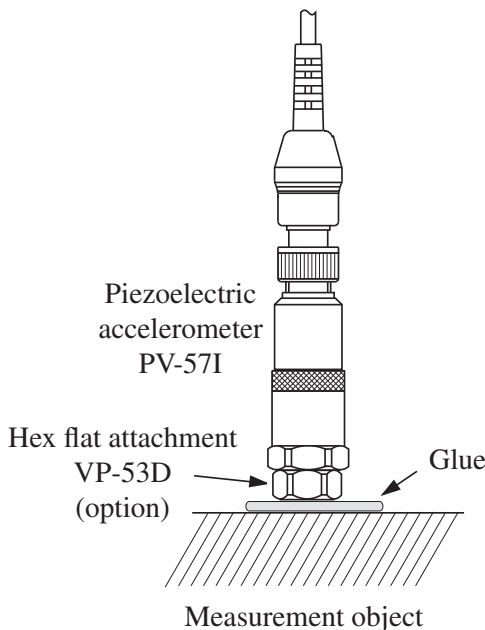

- **Adhesive mounting**
After screw mounting, this method yields the next best vibration characteristics. Instant glue, epoxy type glue, or a similar adhesive material can be used. Take the surface material of the measurement object into consideration when choosing the glue. (For details, refer to the instructions of the glue.) Before attaching the flat hex attachment for the accelerometer, make sure that the surface of the measurement object is completely clean and free from grease. Use a fastening torque of 1 to 1.5 N·m to join the piezoelectric accelerometer to the hex flat attachment.

- Magnet mounting

Because the contact resonance frequency will be quite low, this principle is mainly suited for vibration measurements in the medium to low frequency range. Use a fastening torque of 1 to 1.5 N•m to join the piezoelectric accelerometer to the magnet attachment.

⚠ Caution

The magnet attachment VP-53S is extremely powerful (0.8 kG to 1 kG). Exercise care when attaching it to the measurement object, to prevent injuries. Keep the magnet at least 50 cm away from objects such as magnetic cards or other magnetic media, to prevent data loss.

Do not let go of the VP-53S until it is placed on the surface to be measured. If the attachment slips from your hand, it can exert a strong force on the piezoelectric accelerometer equal to the shock from dropping the unit, which could result in fatal damage.

When placing the piezoelectric accelerometer on the surface to be measured, following the steps below.

1. Verify that the piezoelectric accelerometer is properly connected to the VM-82A.
2. For setup on the surface to be measured, firmly grasp the VP-53S on both sides.
3. Carefully bring the piezoelectric accelerometer into contact with the measuring surface while holding it at an angle.
4. Carefully lower the piezoelectric accelerometer onto the measuring surface until the magnet attachment is in full contact and perpendicular to the surface.

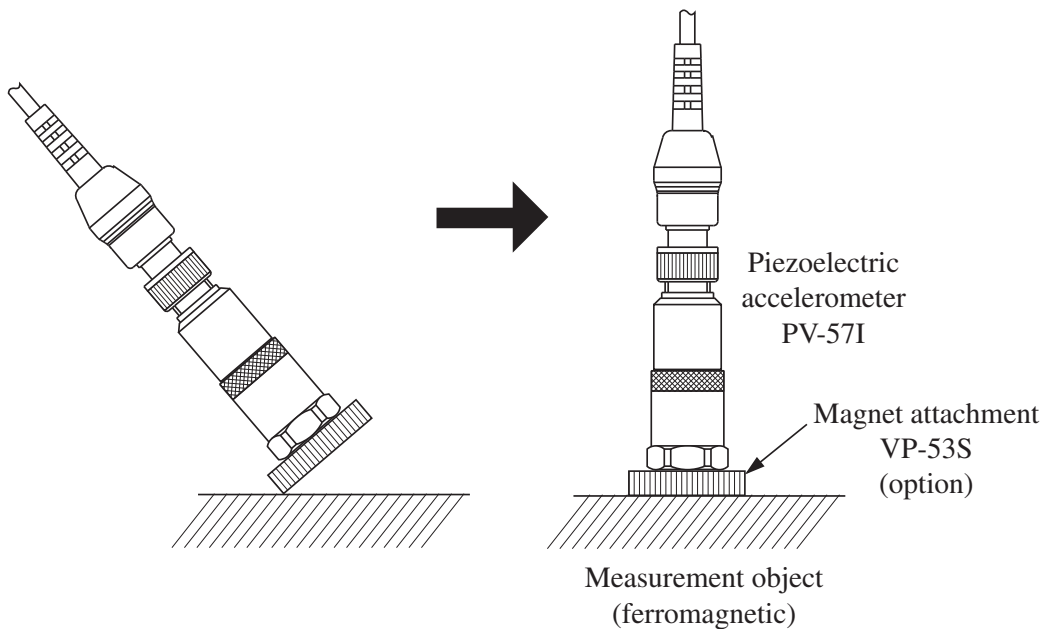

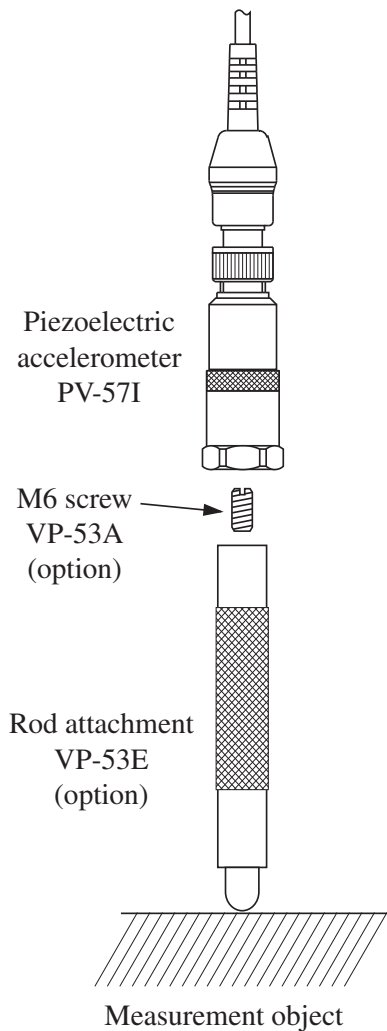

- **Rod attachment mounting**
Pressing the piezoelectric accelerometer against the measurement object with a rod is the simplest method, but it is only suitable for measurements below 500 Hz, because contact resonance frequency will be very low. This method should only be used if the shape or material of the measurement object precludes the use of the other three mounting methods. Use a fastening torque of 1 to 1.5 N·m to join the piezoelectric accelerometer to the rod attachment. The rod attachment is made of aluminum alloy (A5052). Lightly grease the screw thread to prevent screw lockup.

Power-up and version indication/unit initialization

When you keep the POWER key on the front panel of the unit depressed, the unit is turned on and the settings that was active before power was last turned off will appear again.

However, if HOLD or RECALL were active, or if the unit was turned off in the setting mode, the immediately preceding condition will be re-established.

About saving settings

Saving settings in the internal memory are as follows.

Timing of saving process	Settings are saved 10 seconds after setting change is completed
	Settings are saved when turning off the power by the POWER key
Saved items	Accelerometer sensitivity, measurement mode, measurement range, display characteristics, frequency range, store data address

Important

When setting the power-on mode switch to "B", wait at least 10 seconds after changing a setting before turning off the power. Otherwise the current settings will not be restored the next time the unit is turned on.

Version indication

If the unit is turned on while holding down the measurement/setting mode selector (MEAS/MODE) on the front panel, the unit software version will be shown on the display.

Pressing any key in this condition brings up the measurement screen.

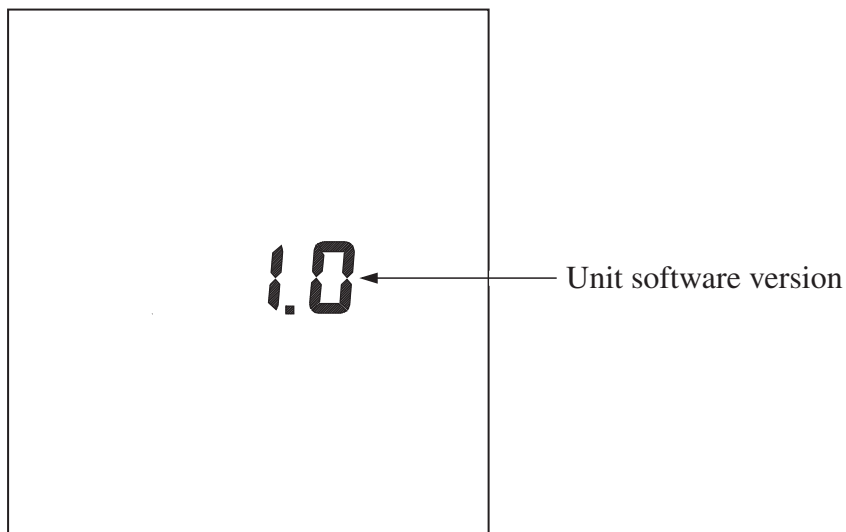

Software version indication

Initialization

If the unit is turned on while holding down the frequency range selector (FREQ RANGE) on the front panel, the unit will start up in the factory default condition, as shown below. Store data is not erased by the initialization.

Measurement mode:	m/s^2 (ACC)
Measurement range:	1000 m/s^2
Display characteristics:	EQ PEAK
Frequency range:	HPF 3 Hz, LPF 1 kHz
Store data address:	000

Setup

Setting mode

Each push of the measurement/setting mode selector toggles between the measurement mode (MEAS) and setting mode (MODE).

Setting the date/time and sensitivity

In the setting mode, the setting item selector [▶] moves the current setting item in the order Year → Month → Day → Hour → Minute → Piezoelectric accelerometer sensitivity → Year etc. The time is set and displayed in 24-hour notation.

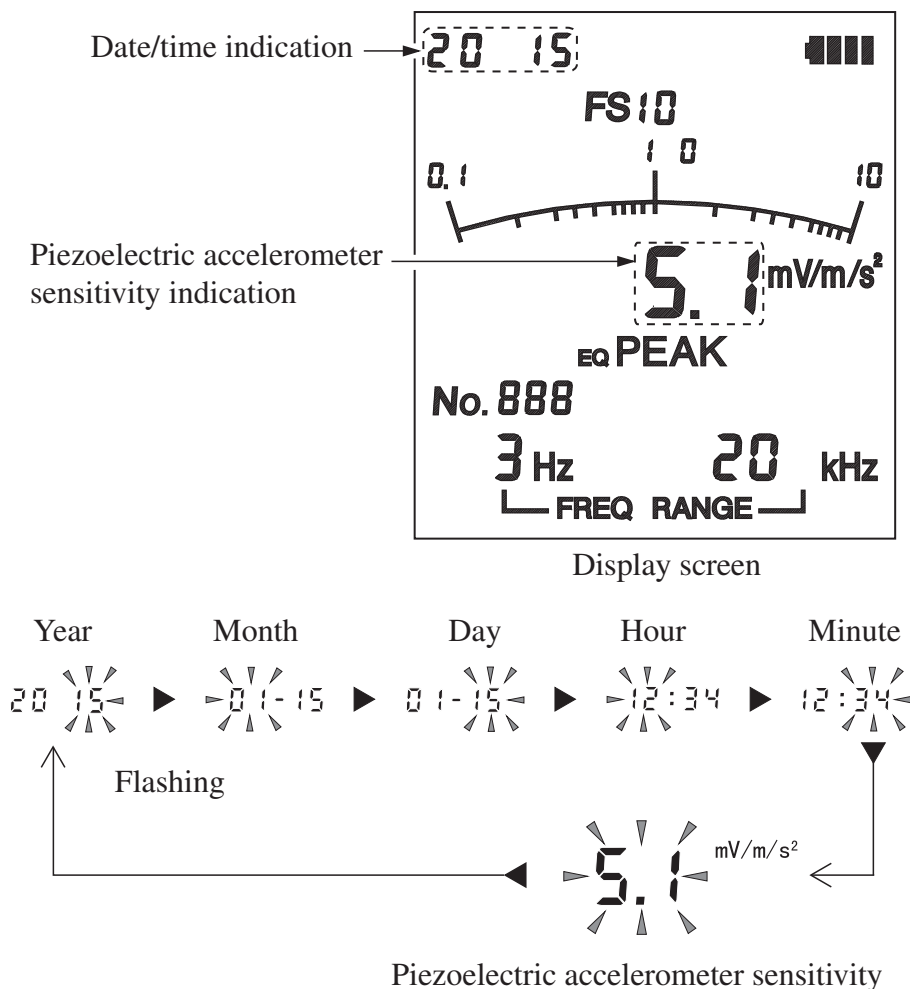

The currently flashing item can be changed. Use the numerical setting keys [▲] [▼] to change the value. Pressing the [▲] key increases the value and pressing the [▼] key decreases it. Keeping a key depressed for 2 seconds or more causes the value to change rapidly.

Backup battery

The unit uses a backup battery (rechargeable battery) to operate the clock.

While power to the unit is on, the backup battery will be charged. It will also be charged while power to the unit is off if external power is connected. The relationship between charging time and retention period is shown below. A full charge of the backup battery is achieved after 24 hours.

Charging time	Retention period
1 hour	2 days
12 hours	30 days
24 hours	45 days

Use the AC adapter when connecting external power for battery charge while the unit is turned off. The service life of the backup battery is limited. You should have the battery replaced about once every five years. Please contact your supplier.

Note

The charging time, retention period and service life of the backup battery may vary depending on the operating condition.

When the backup battery is old, the retention period will be shorter.

Setting the piezoelectric accelerometer sensitivity

Change the setting at the VM-82A so that it matches the sensitivity indicated on the calibration chart of the used piezoelectric accelerometer. Round the sensitivity up as necessary.

1. Cause the piezoelectric accelerometer sensitivity item to flash (see page 28).
2. Use the numerical setting keys [▲] [▼] to change the value. Pressing the [▲] key increases the value and pressing the [▼] key decreases it. Keeping a key depressed for 2 seconds or more causes the value to change rapidly. The display range is 0.10 to 99, with the resolution as indicated below.

Display resolution	0.10 to 1.0	“0.01” steps
	1.0 to 10	“0.1” steps
	10 to 99	“1” steps

圧電式加速度ピックアップ校正表
Calibration Data

型式 PV 571
Model

製造番号 XXXXX
Serial No.

電圧感度 (80Hz) 4.70 mV/(m/s²) ← Charge sensitivity
Voltage Sensitivity

横感度比 (30Hz) -- %
Transverse Sensitivity

測定温度 24 °C
Temperature

測定年月 2014.12
Date

検査責任者
Inspected by

(佐藤)

リオン株式会社 **RION CO., LTD.**

Measurement

Vibration measurement

The following assumes that the preparations described on pages 15 to 25 are completed.

1. Press the POWER key for over two seconds to turn the unit on.
2. Select the measurement mode with the measurement mode selector.
The default settings are shown below. If changes are required, please refer to the section “Setup” on page 28 to 30.

Measurement mode		Frequency range	Display characteristics
ACC (acceleration)	m/s ²	3 Hz to 1 kHz	EQ PEAK
VEL (velocity)	mm/s	10 Hz to 1 kHz	RMS
DISP (displacement)	mm	10 Hz to 500 Hz	EQ PEAK

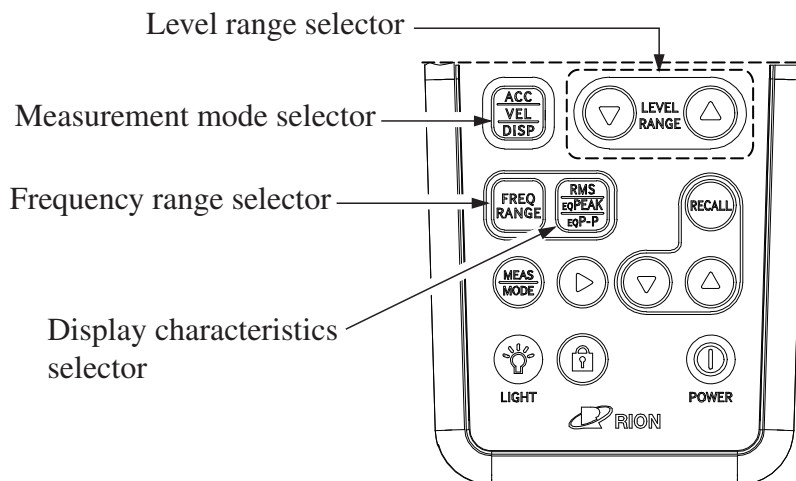

3. Set the frequency range and display characteristics. The relationship between measurement and accelerometer sensitivity, level range, and frequency range is as shown in the table below.

In the ACC mode, when the supplied piezoelectric accelerometer PV-57I is used, the measurement full-scale point can be set to a value between 1 and 1000. Set the frequency range to a setting which suits the measurement purpose.

Measurement mode	Accelerometer sensitivity	Measurement range	Frequency range
ACC (m/s^2)	0.1 to 0.99	10 to 10000	3 Hz to 1 kHz
	1.0 to 9.9	1 to 1000	3 Hz to 5 kHz
	10 to 99	0.1 to 100	3 Hz to 20 kHz 1 Hz to 100 Hz
VEL (mm/s)	0.1 to 0.99	100 to 10000	3 Hz to 1 kHz 10 Hz to 1 kHz*
	1.0 to 9.9	10 to 1000	
	10 to 99	1 to 100	
DISP (mm)	0.1 to 0.99	1 to 1000	3 Hz to 500 Hz 10 Hz to 500 Hz
	1.0 to 9.9	0.1 to 100	
	10 to 99	0.01 to 10	

* The electrical characteristics of 10 Hz to 1 kHz for velocity correspond to JIS B 0907:1989 (Requirements for Instruments to Measure Vibration Severity in Rotational and Reciprocal Machinery).

The measurement range can be further increased by using a different accelerometer.

4. If the input signal overloads the circuitry of the VM-82A, the indication OVER appears and the backlight will come on in red on the display. Adjust the level range with the level range selector so that OVER does not appear and the measurement value is easy to read.

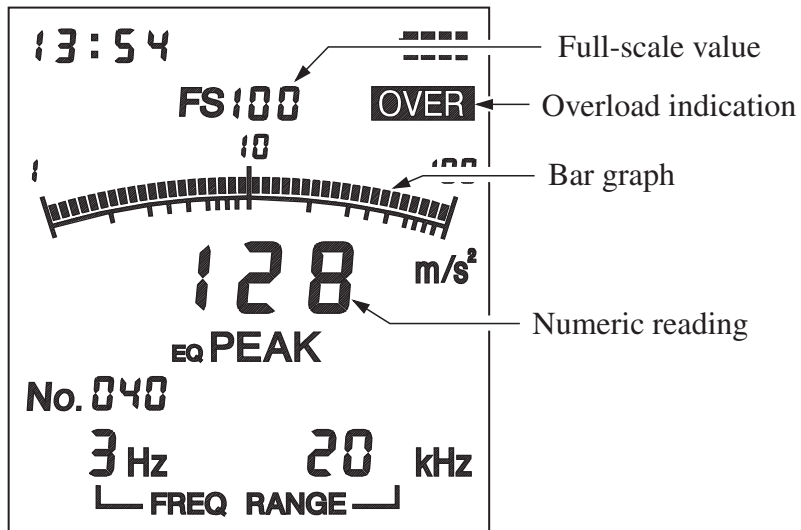

Example for overload (OVER) indication

Note
The indication OVER may appear just after the turning the unit on until the inner circuit becomes stable.

Storing measurement data

Displayed measurement data can be stored in the internal memory. The entire display contents except for the bar graph indication and the battery status indication are stored, as listed below.

- Date and time
 - Measurement range (full-scale value)
 - Measurement value
 - Measurement mode
 - Display characteristics
 - Frequency range
 - Overload yes/no
1. When wishing to store the data in a specific address, use the numerical setting keys to select the address.

Important
When data are stored in an address that already contains data, the previous data will be overwritten.

Note
Pressing and holding the numerical setting keys, the address is fast-forwarded.

2. Press the store key to store the currently displayed data. (It is also possible to use the hold key to freeze the display and then perform the store operation.)

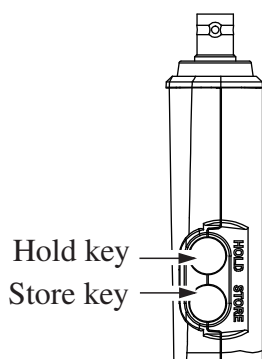

3. When the store key is pressed, the display very briefly turns off and the data are stored. The store address is incremented by 1 count. If the store address currently is 999 and the store key is pressed, the next store address will be 000.

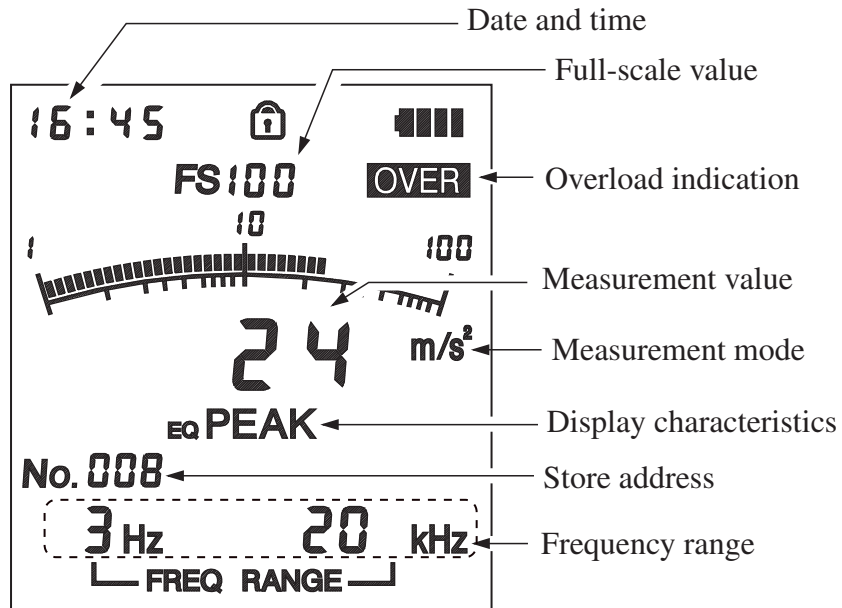

Stored items

Recall mode

When the recall key is pressed, the recall mode is activated. The indication **RECALL** appears on the display and stored data are displayed. Pressing the key again switches back to the measurement mode.

1. Press the recall key to activate the recall mode.
2. Use the numerical setting keys to select the address to be recalled.

Note

Pressing and holding the numerical setting keys, the address is fast-forwarded.

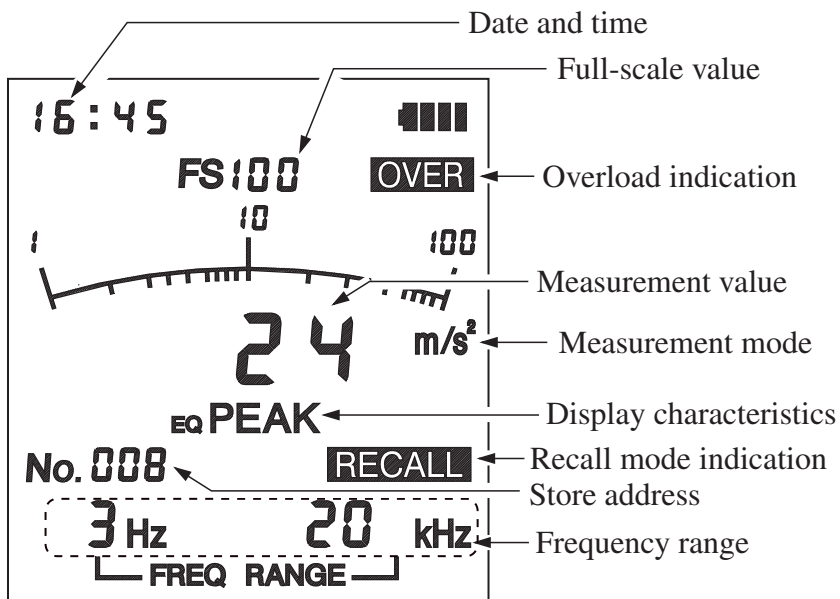
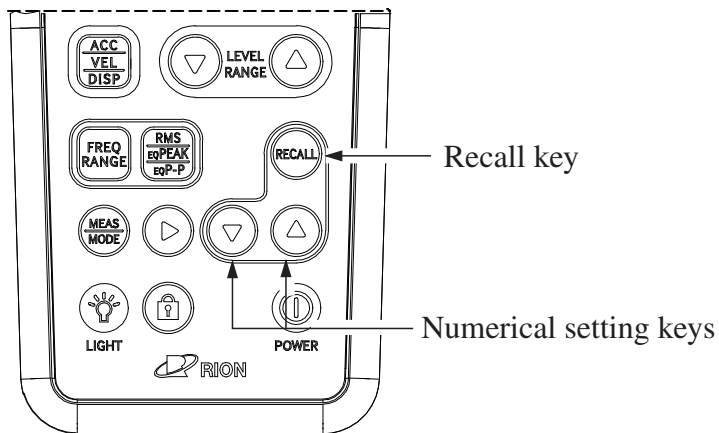

Recall screen example

If there are no stored data in the selected address, “00000” will be shown as below.

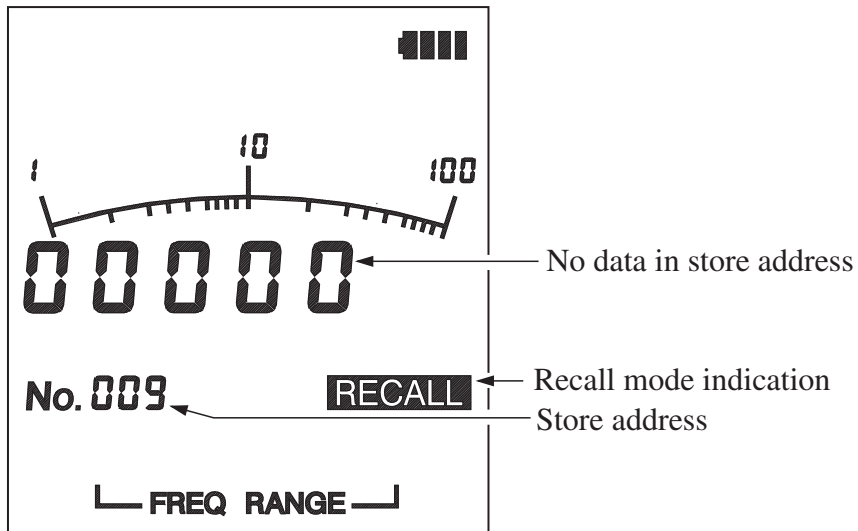

Clearing stored data

If the unit is turned on while holding down the recall key on the front panel, all stored data will be cleared. This process will take five seconds or more and the screen is turned off during the process. When it is completed, the measurement screen appears.

Important

It is not possible to clear only the data in a specific store address. The above operation will clear all stored data.

Output signal recording

On the right side panel of the unit, there are two outputs that allow monitoring and recording of the signal waveform: OUTPUT AC (AC output) and OUTPUT DC (DC output). Use the optional BNC-mini plug cable CC-24 as shown below to make the connection to a frequency analyzer (RIONOTE etc.) or data recorder (DA-21 etc.).

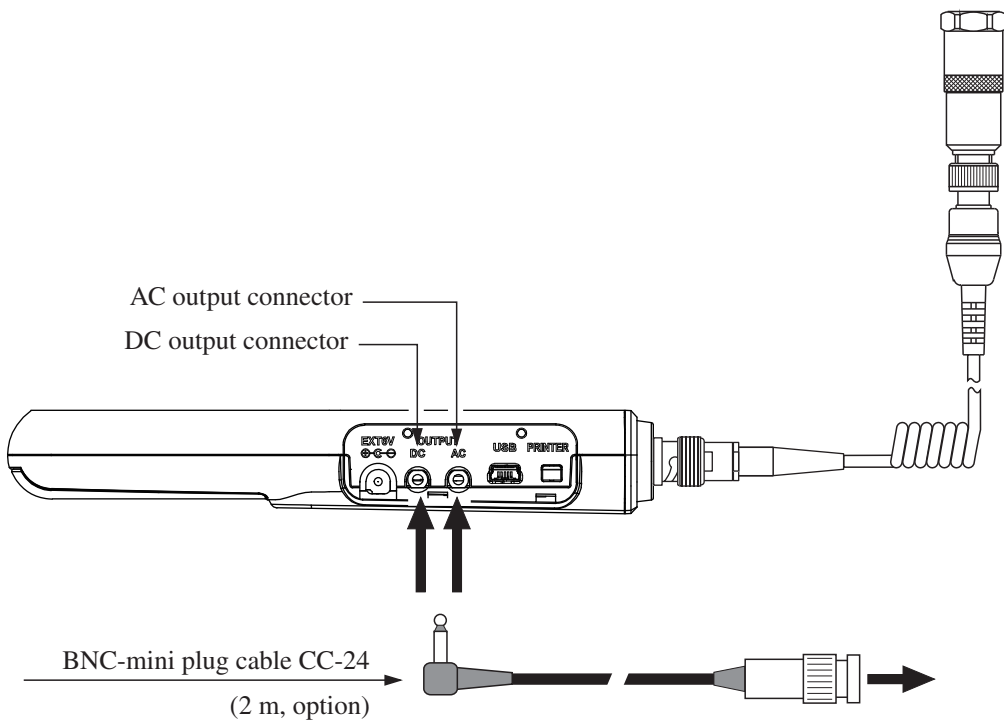

About the AC output signal

The AC output connector on the right side panel of the unit supplies an AC signal corresponding to the selected measurement mode (acceleration/velocity/displacement) and HPF and LPF settings.

The amplitude of the AC signal can be determined from the selected measurement range and voltage value.

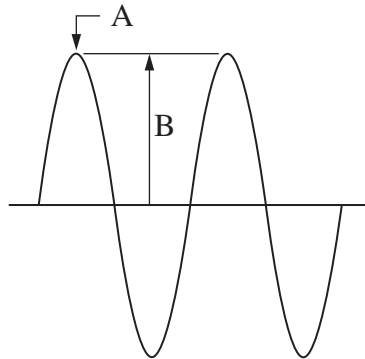

Waveform peak value at point A = B (unit: V) × range full-scale value

Example: Range 10, measurement mode m/s^2

Range	Voltage B	Peak value
10 m/s^2	1 V	10 m/s^2
10 m/s^2	0.5 V	5 m/s^2
10 m/s^2	0.1 V	1 m/s^2

About the DC output signal

The DC output connector on the right side panel of the unit supplies a DC signal that is derived from the AC output signal by rms processing with a time constant of 1 second.

Range full-scale value: 1 V

The measurement value can be determined from the selected measurement range and voltage value, using the graph shown below.

Example: Range 100, measurement mode m/s^2

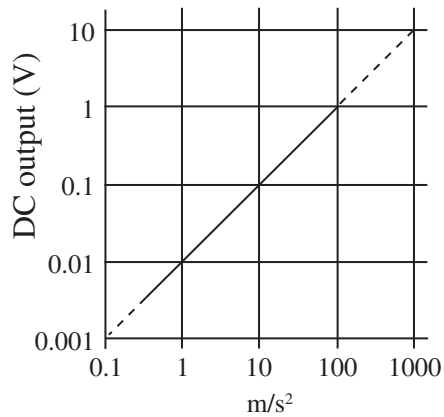

Reference

The representative frequency characteristics of the AC output connector is as follows.

High-pass filter characteristics

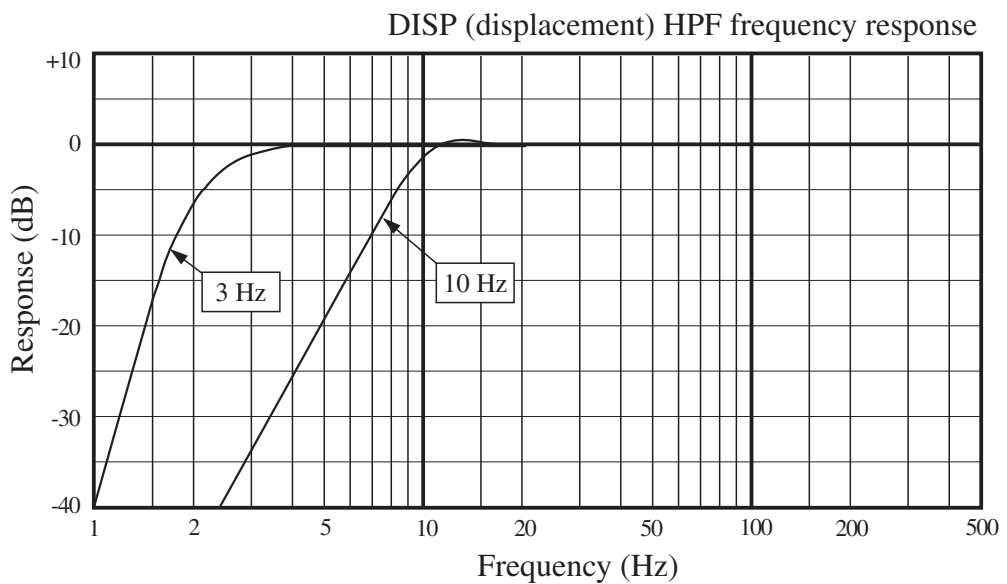
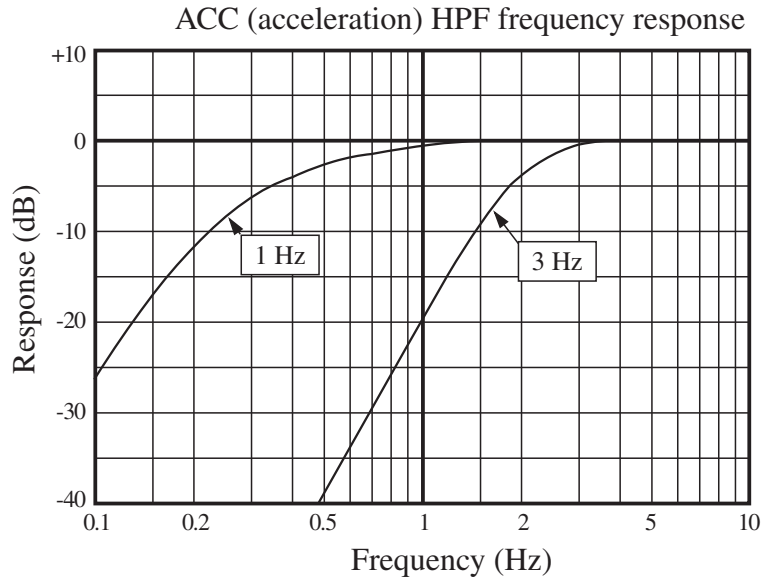

Low-pass filter characteristics

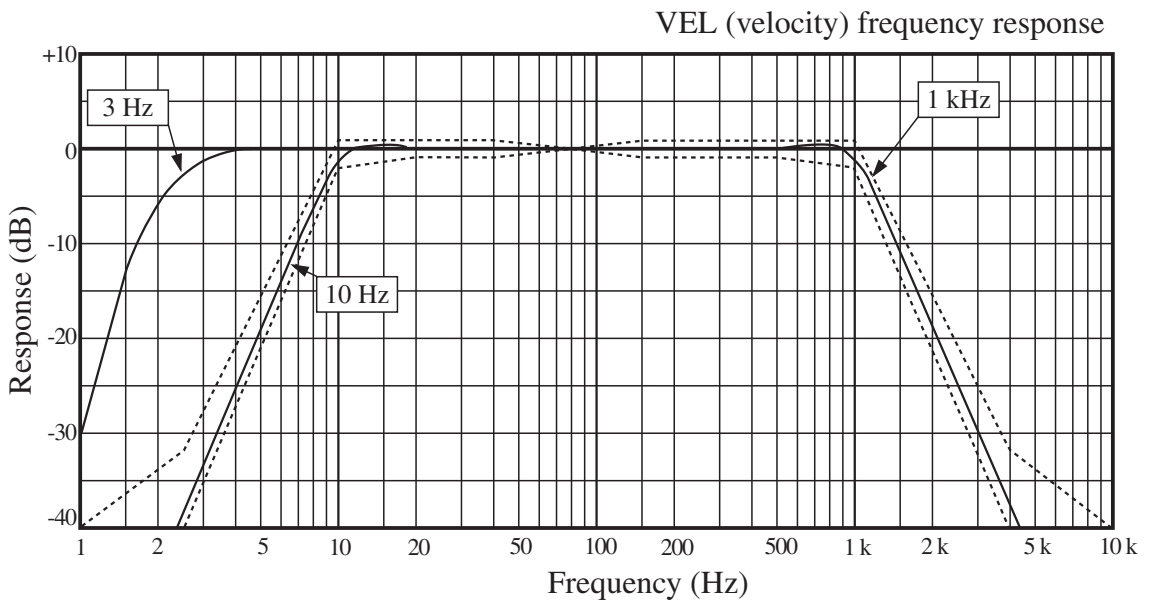
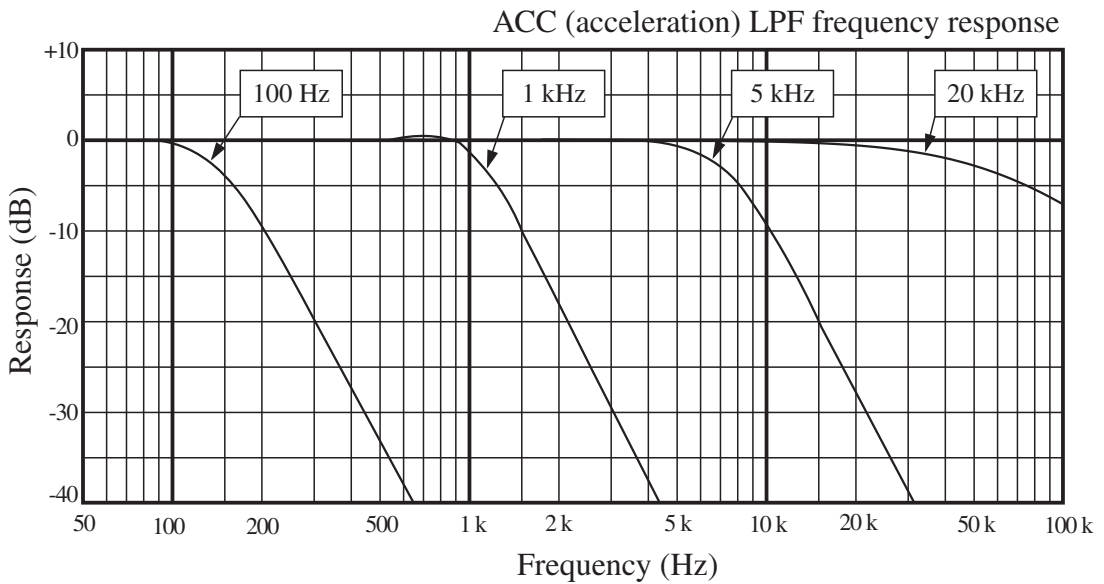

Dotted lines indicate the allowable range according to JIS B 0907:1989

Use of optional accessories

Use of AC adapter

To power the unit from the optional AC adapter NC-98C, establish connections as shown below.

NC-98C: For 100 V to 240 V AC

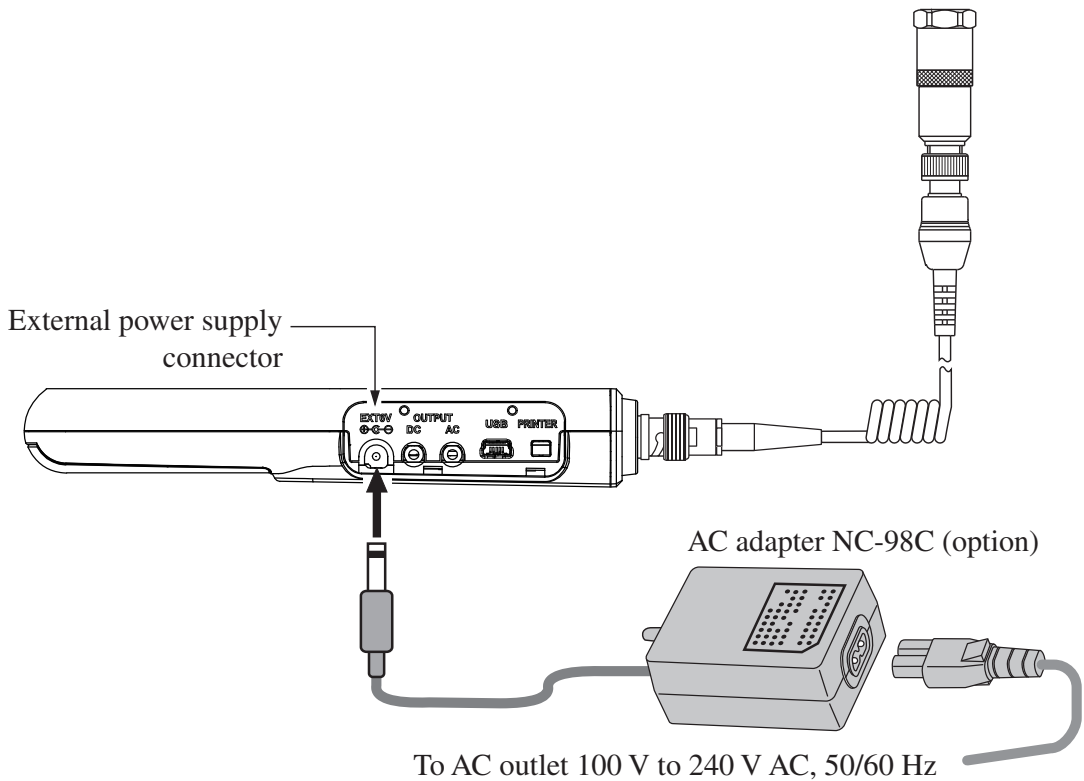

⚠ Caution

Use only the specified AC adapter. Using a different adapter may cause malfunction or damage.

During use of the AC adapter, do not coil up the cable. Do not cover the AC adapter or cable with paper, cloth or any other object, to prevent danger caused by overheating.

After use, always disconnect the AC adapter from the AC outlet.

Connection to a printer

Connect the printer connector on the right side panel of the VM-82A with an input connector of an optional printer DPU-414, using the optional printer cable CC-42P as shown below. The performance of other cables is not guaranteed.

Important

Make sure that the power of the VM-82A and the printer are turned to off before you proceed.

Do not insert the cable connector to the printer connector reversely.

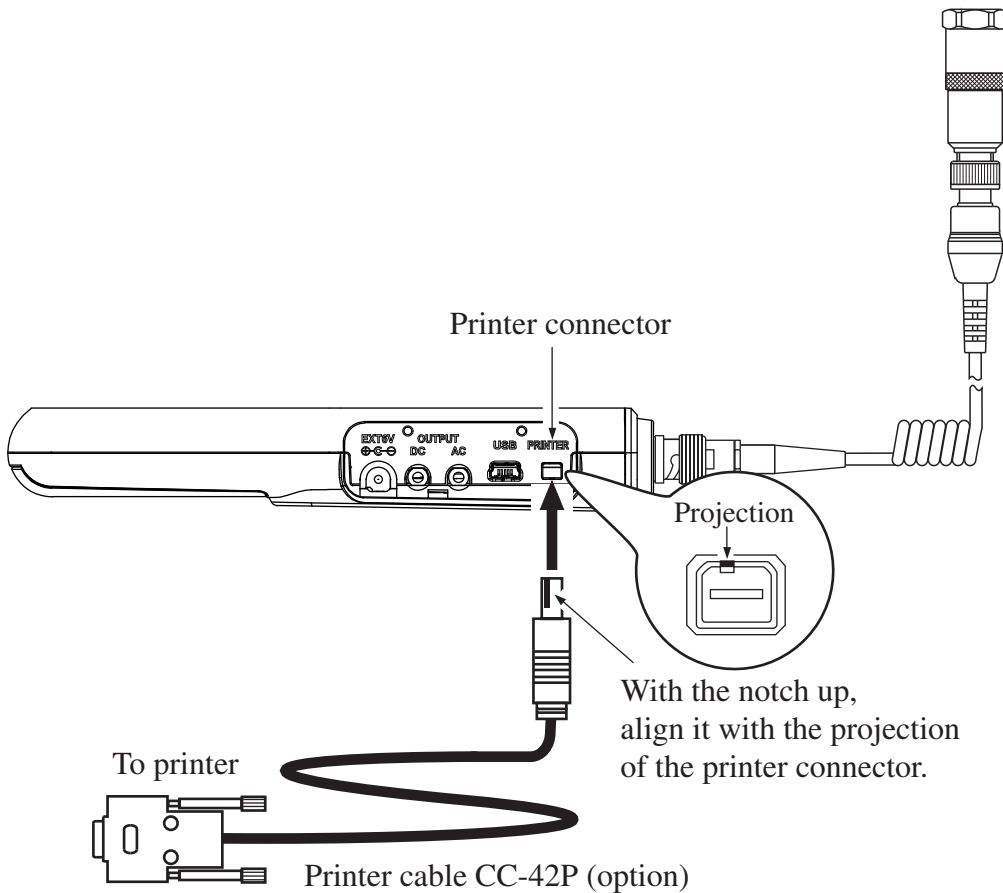

Printing

1. Press the POWER key to turn the VM-82A off.
2. Turn the power of printer on.
3. Press the on-line/off-line switch of the printer so that the on-line indicator is lit.
4. Press the POWER key to turn the VM-82A on. Printing is start.

When printing is not required, disconnect the printer cable.

Setting the software DIP switches of the DPU-414

Turn on the power while holding down the ON LINE switch of the DPU-414.

A printout showing the current status of the printer is produced.

An example showing suitable software DIP switch settings for use of the printer with the VM-82A is shown below. (The actual printout will be in a different font.)

Dip SW-1

- | | | |
|---------|---|--------------------------|
| 1 (OFF) | : | Input = Serial |
| 2 (ON) | : | Printing Speed = High |
| 3 (ON) | : | Auto Loading = ON |
| 4 (ON) | : | Auto LF = ON |
| 5 (ON) | : | Setting Command = Enable |
| 6 (OFF) | : | Printing |
| 7 (ON) | : | Density |
| 8 (ON) | : | 100 % |

Dip SW-2

- | | | |
|--------|---|---------------------------|
| 1 (ON) | : | Printing Columns = 40 |
| 2 (ON) | : | User Font Back-up = ON |
| 3 (ON) | : | Character Select = Normal |
| 4 (ON) | : | Zero = Normal |
| 5 (ON) | : | International |
| 6 (ON) | : | Character |
| 7 (ON) | : | Set |
| 8 (ON) | : | =Japan |

Dip SW-3

- | | | |
|---------|---|-------------------------|
| 1 (ON) | : | Data Length = 8 bits |
| 2 (ON) | : | Parity Setting = No |
| 3 (OFF) | : | Parity Condition = Even |
| 4 (OFF) | : | Busy Control = XON/XOFF |
| 5 (ON) | : | Baud |
| 6 (OFF) | : | Rate |
| 7 (OFF) | : | Select |
| 8 (OFF) | : | = 4800 bps |

For details, please refer to the documentation of the DPU-414.

Printout example

An example for printout using the printer DPU-414 is shown below.

Data are printed out while performing the measurement. Printed values are average value for sample data with 2-second interval (arithmetic average value of 20 data sampled in 100 ms). An asterisk (*) appended to a value lower than the full-scale value means that overload (OVER) has occurred during the 2-second averaging interval.

2015 01/15 12:34				
DISP	mm	EQ PEAK	FS 0.1	*=OVER
FREQ	RANGE	3Hz ~	500Hz	
0.003	0.124*	0.114*	0.049	0.018
0.007	0.003	0.022	0.057	0.037
0.018	0.014	0.089*	0.116*	0.051
0.029	0.021	0.008	0.008	0.021
0.013	0.018	0.024	0.021	0.017
0.017	0.015	0.020	0.041	0.017
2015 01/15 12:35				
0.017	0.024	0.023	0.015	0.025
0.111*	0.099*	0.038	0.019	0.017
0.028	0.023	0.019	0.031	0.026
0.050*	0.127*	0.109*	0.082*	0.127*
0.095*	0.037	0.014	0.006	0.010
0.014	0.011	0.010	0.009	0.009
2015 01/15 12:36				
0.011	0.010	0.010	0.010	0.014

An example for printout of recalled data is shown below.

No. 000	2015	01/16	11:55		
	4.2 m/ss	EQ PEAK	FS	10	
	FREQ RANGE	3Hz ~		1kHz	
No. 001	2015	01/16	11:55		
	2.6 m/ss	EQ PEAK	FS	10	
	FREQ RANGE	3Hz ~		1kHz	
No. 002	2015	01/16	11:56		
	1.08 m/ss	RMS	FS	1	
	FREQ RANGE	1Hz ~		100Hz	
No. 003	2015	01/16	11:56		
	0.43 m/ss	RMS	FS	1	
	FREQ RANGE	1Hz ~		100Hz	
No. 004	2015	01/16	11:56		
	38 mm/s	RMS	FS	100	
	FREQ RANGE	10Hz ~		1kHz	
No. 005	2015	01/16	11:57		
	70 mm/s	RMS	FS	1000	
	FREQ RANGE	10Hz ~		1kHz	
No. 006	2015	01/16	11:58		
	0.4 mm	EQ PEAK	FS	10	
	FREQ RANGE	3Hz ~		500Hz	

Stored data ranging from the address number selected when the recall key was pressed to address number 999 are printed out.

For printing recalled data, establish settings by completing the procedures on page 45 and press the recall key.

Connection to a computer

When connecting the VM-82A to a computer, use the optional A-miniB USB cable and make the connection as shown below.

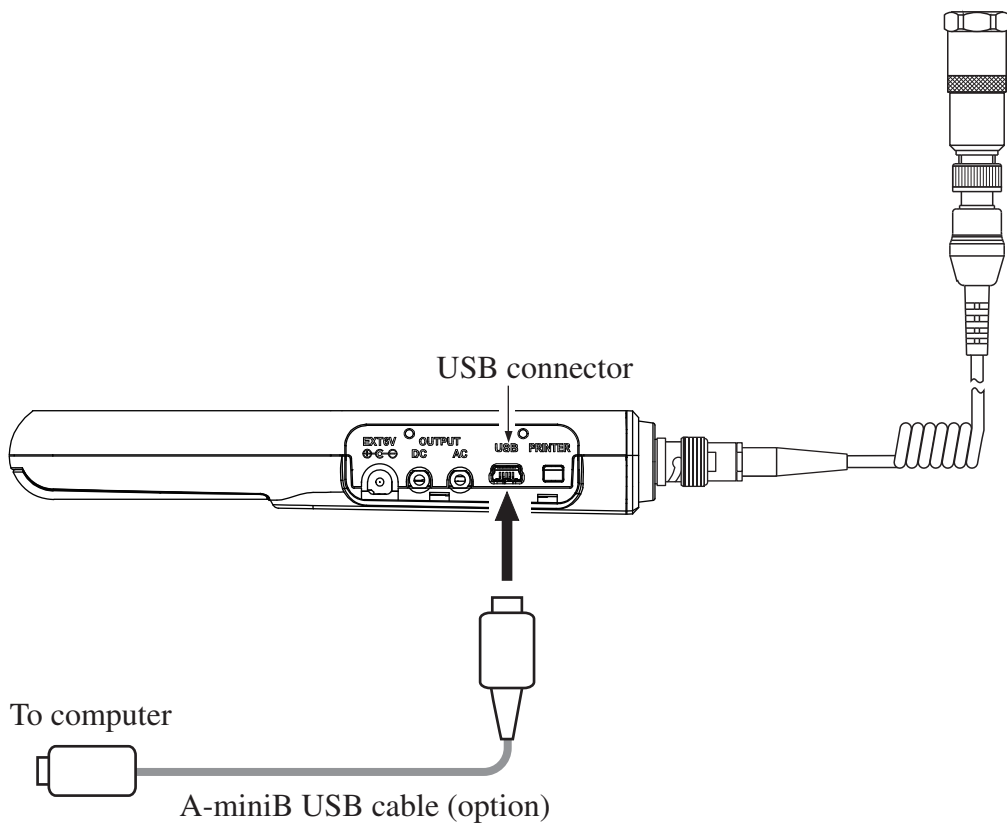

VM-82A data transfer software

For taking the data from the VM-82A, the VM-82A data transfer software is provided. The software can be downloaded from RION CO., LTD web site. The VM-82A data transfer software is designed to run under Microsoft Windows 7 Professional (32bit/64bit), Windows 8 Pro (64bit) and Windows 8.1 Pro (64bit).

Measurement result data and saved data downloaded from the VM-82A can be stored in CSV file format, allowing further edit and tabulation for using a generic application software (spreadsheet software).

The following figure is the example which read measurement result data using VM-82A data transfer software.

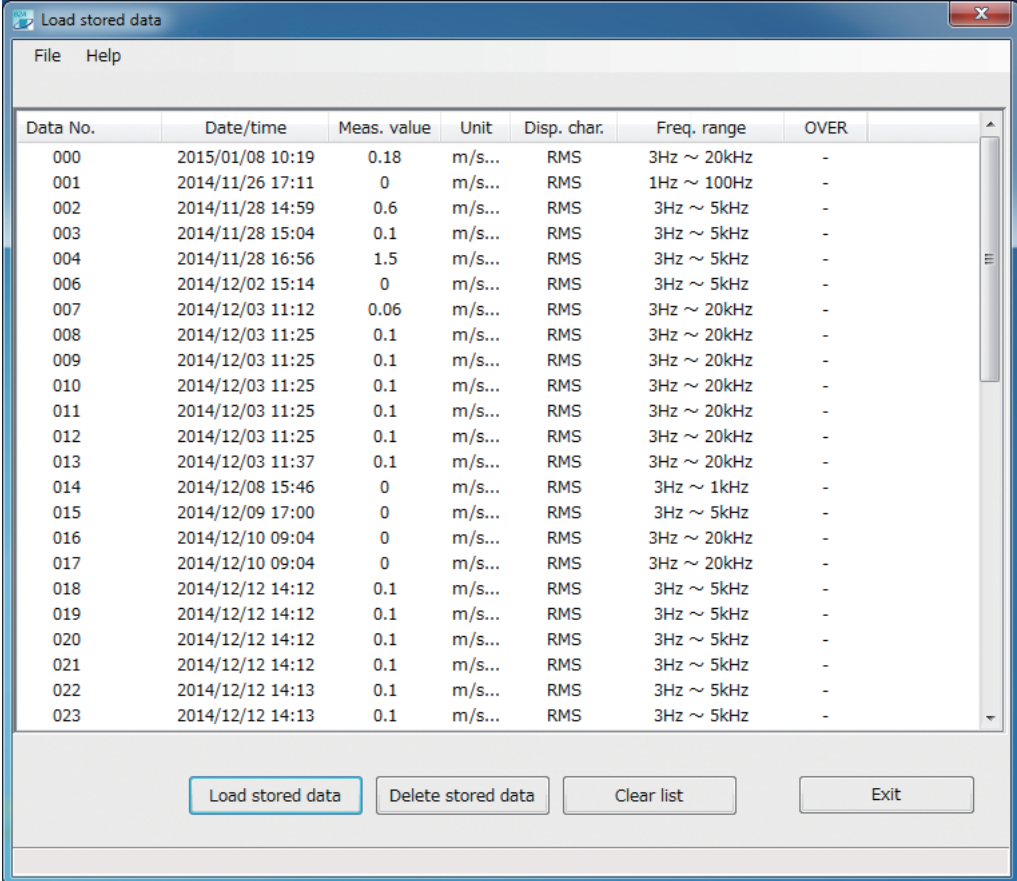

The screenshot shows a software window titled "Load stored data" with a menu bar containing "File" and "Help". The main area displays a table with the following columns: Data No., Date/time, Meas. value, Unit, Disp. char., Freq. range, and OVER. The table contains 24 rows of data, with the last row (Data No. 023) partially cut off. Below the table are four buttons: "Load stored data", "Delete stored data", "Clear list", and "Exit".

Data No.	Date/time	Meas. value	Unit	Disp. char.	Freq. range	OVER
000	2015/01/08 10:19	0.18	m/s...	RMS	3Hz ~ 20kHz	-
001	2014/11/26 17:11	0	m/s...	RMS	1Hz ~ 100Hz	-
002	2014/11/28 14:59	0.6	m/s...	RMS	3Hz ~ 5kHz	-
003	2014/11/28 15:04	0.1	m/s...	RMS	3Hz ~ 5kHz	-
004	2014/11/28 16:56	1.5	m/s...	RMS	3Hz ~ 5kHz	-
006	2014/12/02 15:14	0	m/s...	RMS	3Hz ~ 5kHz	-
007	2014/12/03 11:12	0.06	m/s...	RMS	3Hz ~ 20kHz	-
008	2014/12/03 11:25	0.1	m/s...	RMS	3Hz ~ 20kHz	-
009	2014/12/03 11:25	0.1	m/s...	RMS	3Hz ~ 20kHz	-
010	2014/12/03 11:25	0.1	m/s...	RMS	3Hz ~ 20kHz	-
011	2014/12/03 11:25	0.1	m/s...	RMS	3Hz ~ 20kHz	-
012	2014/12/03 11:25	0.1	m/s...	RMS	3Hz ~ 20kHz	-
013	2014/12/03 11:37	0.1	m/s...	RMS	3Hz ~ 20kHz	-
014	2014/12/08 15:46	0	m/s...	RMS	3Hz ~ 1kHz	-
015	2014/12/09 17:00	0	m/s...	RMS	3Hz ~ 5kHz	-
016	2014/12/10 09:04	0	m/s...	RMS	3Hz ~ 20kHz	-
017	2014/12/10 09:04	0	m/s...	RMS	3Hz ~ 20kHz	-
018	2014/12/12 14:12	0.1	m/s...	RMS	3Hz ~ 5kHz	-
019	2014/12/12 14:12	0.1	m/s...	RMS	3Hz ~ 5kHz	-
020	2014/12/12 14:12	0.1	m/s...	RMS	3Hz ~ 5kHz	-
021	2014/12/12 14:12	0.1	m/s...	RMS	3Hz ~ 5kHz	-
022	2014/12/12 14:13	0.1	m/s...	RMS	3Hz ~ 5kHz	-
023	2014/12/12 14:13	0.1	m/s...	RMS	3Hz ~ 5kHz	-

* Microsoft and Windows are registered trademarks or trademarks of Microsoft Corporation in the U.S. and other countries.

Specifications

Applicable standards

CE marking, WEEE Directive, Chinese RoHS, KC mark

Piezoelectric accelerometer PV-57I (supplied accessory)

Accelerometer type

Shear-type piezoelectric accelerometer (CCLD type)

Sensitivity Listed on supplied calibration chart of PV-57I.

Frequency range 1 Hz to 5 kHz ($\pm 10\%$)

Dimensions 17 mm (width across hexagonal flat) \times 49 mm

Weight Approx. 45 g

Other usable accelerometer types

Accelerometers with integrated preamplifier rated for 2 mA drive current can be connected via BNC adapter VP-52C and connection cable VP-51 series.

Accelerometers without integrated preamplifier can be connected via charge converter VP-40/VP-42 and connection cable VP-51 series.

Accelerometers rated for 4 mA drive current can be also connected by the remodeling option.

Sensor drive power (CCLD)

2 mA, 24 V

Measurement range (with PV-57I)

Acceleration (ACC)

0.02 to 200 m/s² EQ PEAK 1 Hz to 5 kHz

Velocity (VEL) 0.3 to 1000 mm/s RMS 3 Hz to 1 kHz

0.1 to 1000 mm/s RMS 10 Hz to 1 kHz

Displacement (DISP)

0.02 to 100 mm EQ PEAK 3 Hz to 500 Hz

0.001 to 100 mm EQ PEAK 10 Hz to 500 Hz

Upper and lower measurement limit may be further restricted, depending on accelerometer mounting method.

Upper measurement limit for velocity and displacement measurements is restricted by maximum input acceleration.

Frequency range

Acceleration (ACC)

3 Hz to 1 kHz, 3 Hz to 5 kHz, 1 Hz to 100 Hz, 3 Hz to 20 kHz

Velocity (VEL) 10 Hz to 1 kHz, 3 Hz to 1 kHz

Displacement (DISP)

10 Hz to 500 Hz, 3 Hz to 500 Hz

The above figures refer to the point where response is down by 10% from flat response, due to the action of a high-pass filter or low-pass filter. For displacement measurements, the 500 Hz limit is imposed by the maximum input acceleration. The electrical characteristics of 10 Hz to 1 kHz for velocity correspond to JIS B 0907:1989 (Requirements for Instruments to Measure Vibration Severity in Rotational and Reciprocal Machinery).

Measurement range settings

For piezoelectric accelerometer PV-57I and

accelerometers with sensitivity 1.0 to 9.9 mV/(m/s²) (1.0 to 9.9 pC/(m/s²))

Acceleration (ACC)

1, 10, 100, 1000 m/s²

Velocity (VEL)

10, 100, 1000 mm/s

Displacement (DISP)

0.1, 1, 10, 100 mm

When accelerometer sensitivity is 0.1 to 0.99 mV/(m/s²) (0.1 to 0.99 pC/(m/s²))

Acceleration (ACC)

10, 100, 1000, 10000 m/s²

Velocity (VEL)

100, 1000, 10000 mm/s

Displacement (DISP)

1, 10, 100, 1000 mm

When accelerometer sensitivity is 10 to 99 mV/(m/s²) (10 to 99 pC/(m/s²))

Acceleration (ACC)

0.1, 1, 10, 100 m/s²

Velocity (VEL)

1, 10, 100 mm/s

Displacement (DISP)

0.01, 0.1, 1, 10 mm

Display characteristics

Acceleration EQ PEAK, RMS

Velocity RMS, EQ PEAK

Displacement EQ PEAK, EQp-p, RMS

EQ PEAK = RMS $\times \sqrt{2}$

EQ p-p = EQ PEAK $\times 2$

Time constant of rms processing

1 second

Data memory

Maximum 1000 data (000 to 999) can be stored manually. Stored data is displayed in recall mode.

Stored data comprise all display contents except key lock and battery status.

LCD panel

Measurement value display range:

001 to 128

Average of 20 100-ms sampling data is displayed, updated every 2 seconds

Bar graph display Logarithmic scale, full-scale 1 to 100%

Display characteristics

RMS, EQ PEAK, EQp-p

Measurement modes

m/s² (acceleration), mm/s (velocity), mm (displacement)

Frequency range Selected range for each measurement mode shown at bottom of display

Memory addresses 000 to 999 (1000 addresses)

Battery status indication

4-segment display

Clock indication Year, month, day, hour, minute

Accelerometer sensitivity	0.10 to 0.99, 1.0 to 9.9, 10 to 99 mV/m/s ²
Backlight	White LED type backlight If an overload condition has occurred, the backlight comes on in red
Gain calibration	After setting the accelerometer sensitivity, calibration is performed to provide proper gain.
Setting range	0.10 to 0.99, 1.0 to 9.9, 10 to 99 pC/m/s ² (mV/m/s ²)
Overload indication	“OVER” shown on LCD panel and the backlight comes on in red
Output	
AC output	Range full-scale: 1 V (at most about 10 V) Output impedance: approx. 600 Ω
DC output	Range full-scale: 1 V (at most about 10 V) Output impedance: approx. 600 Ω
Output voltage and display accuracy (electrical characteristics)	
Acceleration (ACC)	Range full-scale ±2% (80 Hz)
Velocity (VEL)	Range full-scale ±3% (80 Hz)
Displacement (DISP)	Range full-scale ±5% (80 Hz)
Overall accuracy (in combination with PV-57I)	
Acceleration (ACC)	Range full-scale ±5% (80 Hz)
Velocity (VEL)	Range full-scale ±8% (80 Hz)
Displacement (DISP)	Range full-scale ±10% (80 Hz)
Interfaces	
USB interface	For taking the stored data into the computer using dedicated “Data transfer software for VM-82A” (downloadable from RION web site)
Printer interface	For data output to the connected printer (DPU-414)

Ambient conditions

Piezoelectric accelerometer PV-57I

-20°C to +70°C, max. 90% RH

Main unit

-10°C to +50°C, max. 90% RH

Power requirements Four IEC R6 batteries (alkaline batteries or nickel-metal hydride batteries) or AC adapter

AC adapter

NC-98C (for 100 V to 240 V AC, optional)

Input: 100 V to 240 V AC, 50/60 Hz, 0.4 A

Output: 5.9 V DC, 2 A, 11.8 W

Power consumption

Approx. 58 mA (6 V, backlight off, communication off)

Battery life

(continuous use, on room temperature, backlight off, communication off, accelerometer in stable condition)

Alkaline batteries (LR6): approx. 30 hours

Nickel-metal hydride batteries (HR6)

eneloop XX: approx. 32 hours

Dimensions

171.5 mm (H) × 74 mm (W) × 25.5 mm (D)

(maximum)

155 mm (H) × 74 mm (W) × 25.5 mm (D)

(without protruding parts)

Weight

Approx. 270 g (including four alkaline batteries, but excluding accelerometer and curled cable)

Supplied accessories

Piezoelectric accelerometer	PV-57I	1
Accessories for PV-57I		
Curled cable	VP-51KI	1
Magnet attachment	VP-53S	1
IEC R6 batteries		4
Instruction manual (CD-ROM)		1
Concise manual		1
PV-57I calibration chart		1
Inspection certificate		1

Optional accessories

Piezoelectric accelerometer with integrated preamplifier	PV-41 and others
Piezoelectric accelerometer	PV-85 and others
Charge converter	VP-40, VP-42
Connection cable	VP-51 series
BNC adapter	VP-52C
Rod attachment	VP-53E
Hex flat attachment	VP-53D
M6 screw	VP-53A
Printer	DPU-414
Calibration exciter	VE-10
AC adapter	NC-98C
Printer cable	CC-42P
BNC-mini plug cable	CC-24
Soft carrying case	VM-82-015

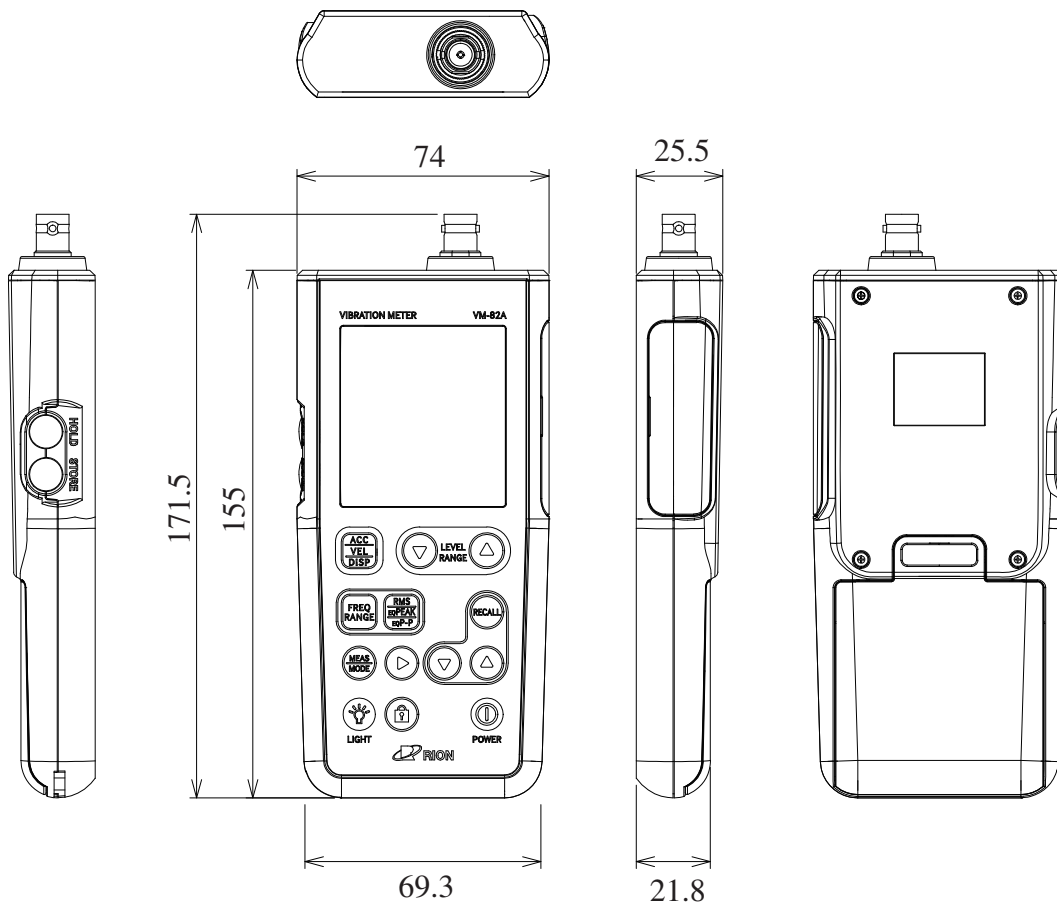

Unit: mm

VM-82A external dimensions

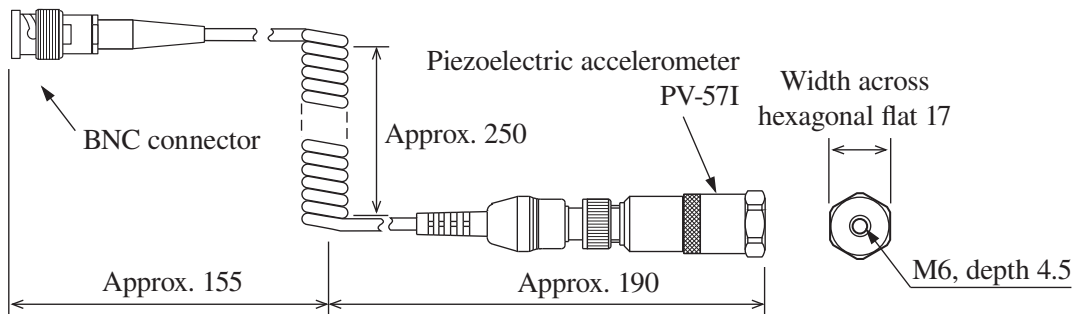

Unit: mm

PV-57I external dimensions

